



**SURGICAL INSTRUMENTS
CATALOGUE**

ABOUT US

We are manufacturer and exporter of surgical instruments, dental instruments, hollowware, manicure and pedicure. We are manufacturing instruments in a high quality controlled under the supervision of highly qualified engineers / professional to satisfy our customers.

The quality management system has been properly implemented and is successfully working at all production stages. We carry out all the necessary tests, inspections and process control activities to ensure that there is no problem with the instruments performance.

The technical specifications are provided for more understanding of the products and to improve the confidence of the customer.













Samples and prices can be obtained on demand. Deliveries of the orders are ensured within time. Although this website doesn't cover all the range of surgical instruments, dental instruments, manicure and pedicure, yet it assures you that we can make every type of instruments. So we will welcome your all inquiries, also for your required instruments which have not been listed in this website.













If you have any queries, please don't hesitate to contact us.

Chief Executive



▪ CONTENTS

01		Scalpels Skalpelle Bisturías	Page 01 to 05
02		Diagnostics Diagnostik Diagnóstico	Page 16 to 21
03		Trocars, Vaccination Impfen, Punktion Vacunación, Punción	Page 22 to 29
04		Anaesthesia Narkose Anestesia	Page 30 to 38
05		Scissors Scheren Tijeras	Page 39 to 81
06		Forceps Pinzetten Pinzas	Page 82 to 98
07		Artery Forceps Arterienklemmen Pinzas hemostáticas	Page 99 to 127
08		Cotton Swab Forceps Tupfer-und Kornzangen Pinzas para tapones y curaciones	Page 128 to 131
09		Suture Naht Sutura	Page 132 to 162
10		Probes, Applicators, Spatulas Sonden, Watteträger, Spatel Sondas, Porta-algodones, Espátulas	Page 163 to 168
11		Retractors Wundhaken und -sperrer Separadores	Page 169 to 217
12		Bone Surgery Knochenchirurgie Cirugía ósea	Page 218 to 291
13		Plaster Instruments Plaster Instrumente Instrumentos de yeso	Page 292 to 294

Page 295 to 334	Cardiovascular Surgery Herz- und Gefäßchirurgie Cirugía cardiovascular		14
Page 335 to 365	Neurosurgery Neurochirurgie Neuro Cirugía		15
Page 366 to 396	Ophthalmology Ophthalmologie Oftalmología		16
Page 397 to 414	Otology Otologie Otología		17
Page 415 to 439	Rhinology Rhinologie Rinología		18
Page 440 to 444	Oral Instruments Mund instrumente Cirugía oral		19
Page 445 to 451	Tonsil Mandel Amígdala		20
Page 452 to 456	Tracheotomy Tracheotomie Traqueotomía		21
Page 457	Goitre Kropfchirurgie Bocio		22
Page 458 to 459	Dermatology Dermatologie Dermatología		23
Page 460 to 481	Stomach, Intestine, Rectum Magen, Darm, Mastdarm Estómago, Intestinos, Recto		24
Page 482 to 495	Kidney, Liver, Gall Stone, Urology Niere, Leber, Galle, Urologie Riñón, Hígado, Bilis, Urología		25
Page 496 to 535	Gynecology Gynäkologie Ginecología		26

▪ CONTENTS

27		Obstetrics Geburtshilfe Obstetricia	Page 536 to 542
28		Sterilization Sterilisation Esterilización	Page 543 to 544
29		Asepsis Asepsis Asepsia	Page 545 to 546
30		Hollowware Holloware Hollowware	Page 547 to 552

EN Scalpels

DE Skalpelle

ES Bisturías

Page 1 to 14

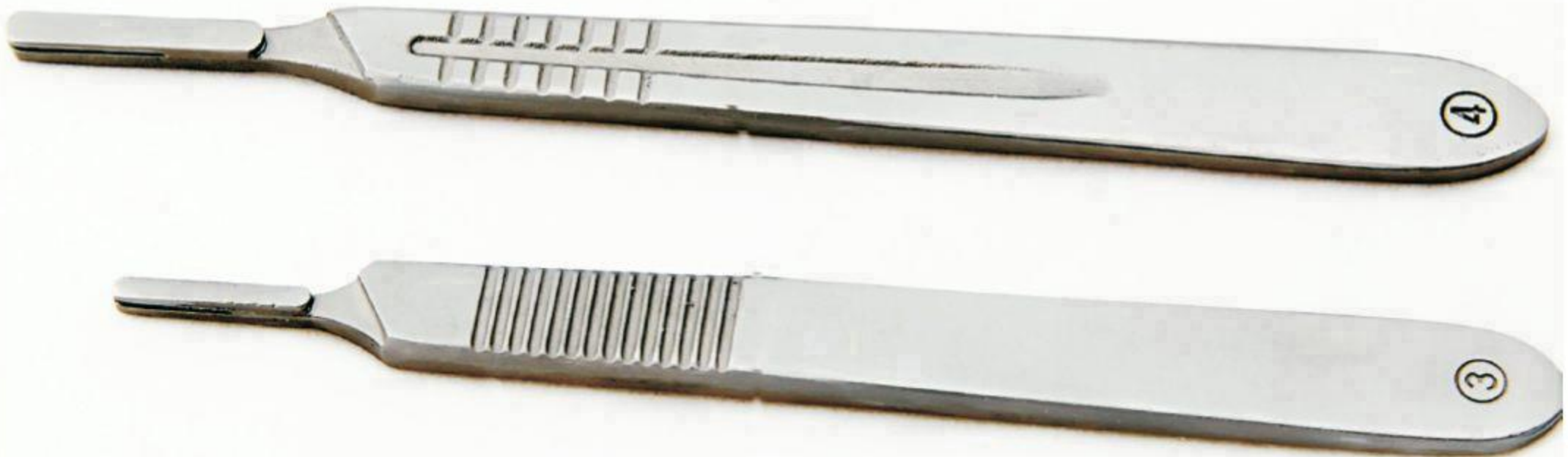

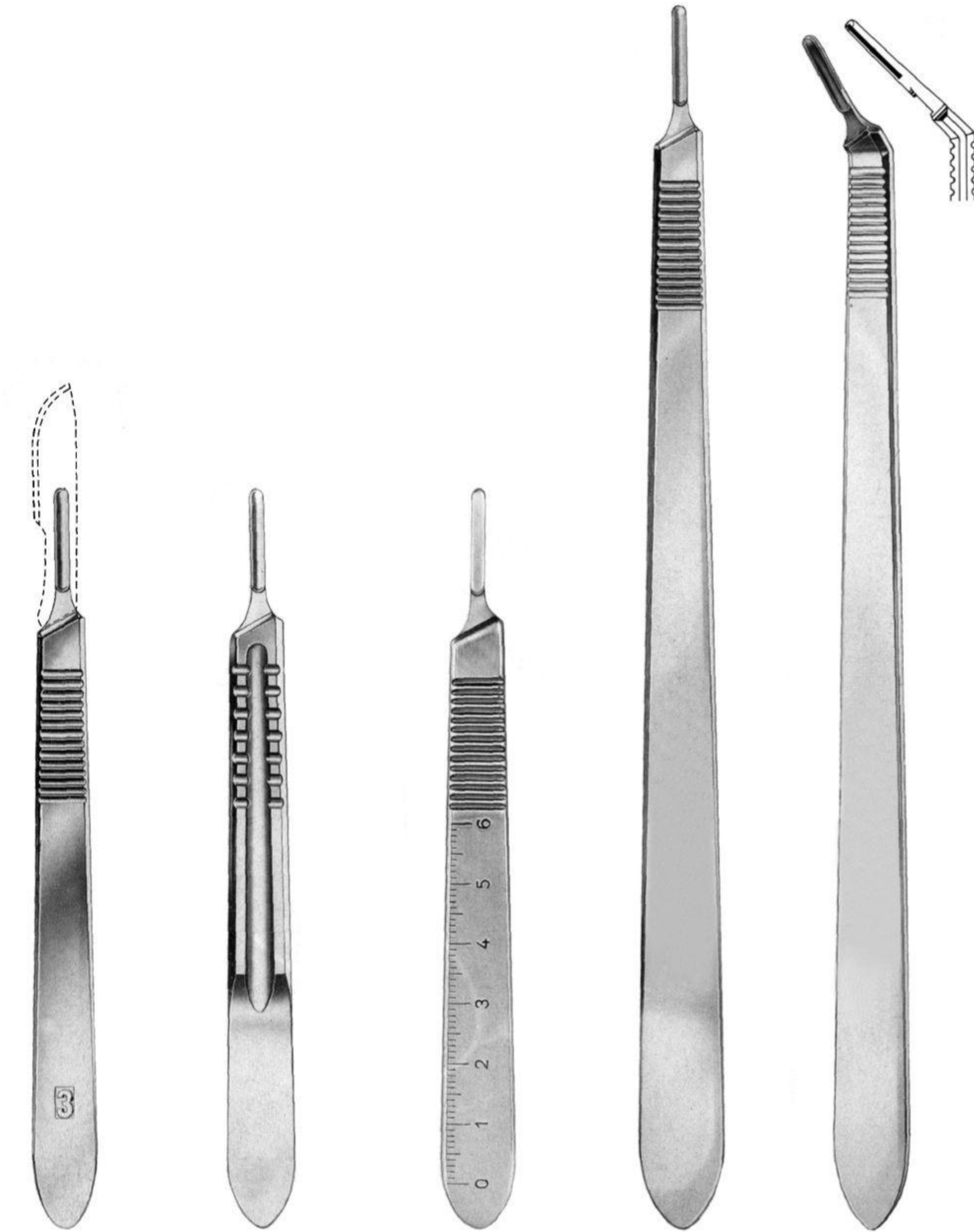

Standard
01-1000-03 # 3

01-1001-03 # 3

01-1002-03 # 3

01-1003-3L # 3L
01-1003-3XL # 3XL

01-1004-3L # 3L
01-1004-3XL # 3XL
angled

Scalpel Handles ● EN
 Skalpelli-Griffe ● DE
 Mangos de bisturios ● ES

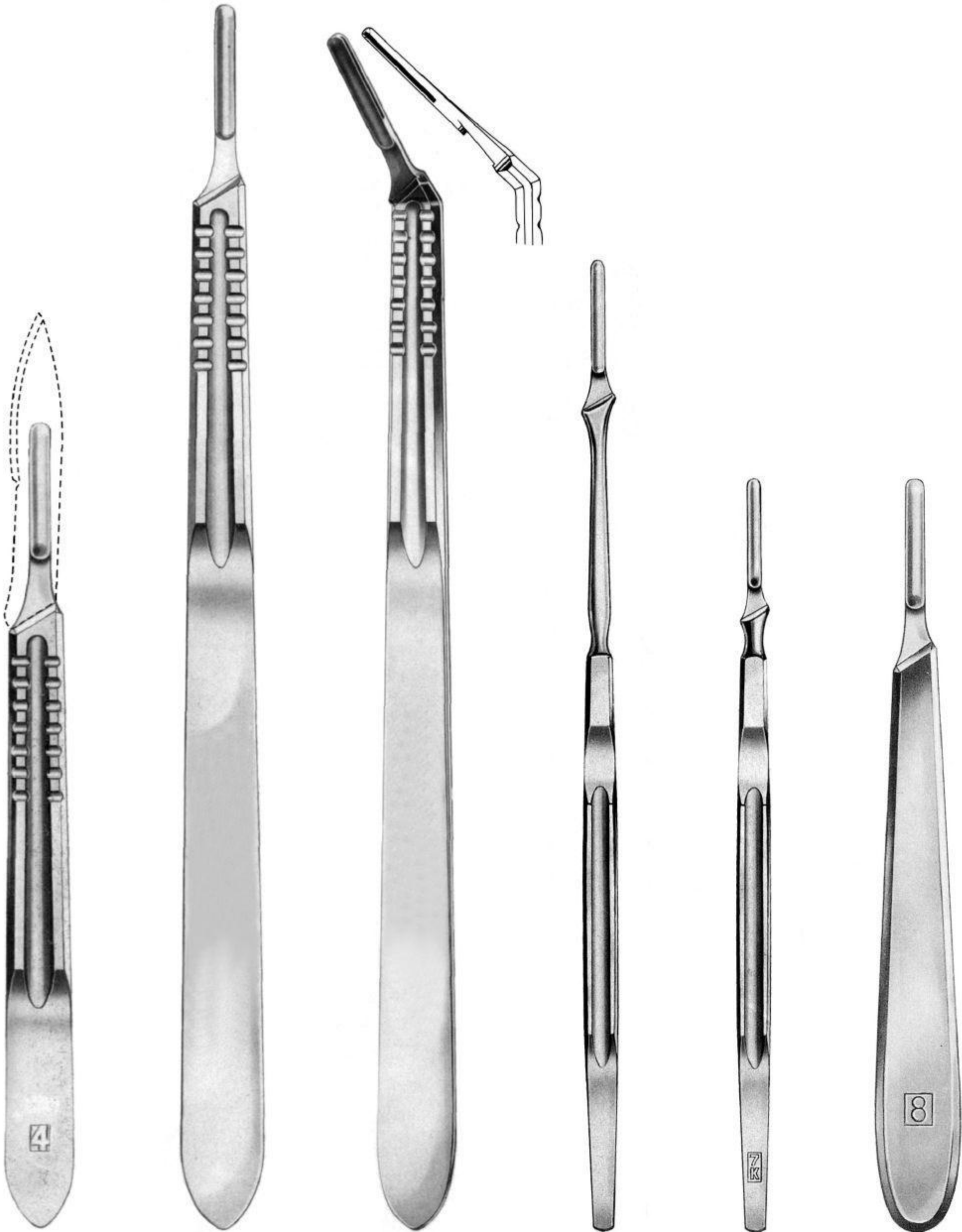

Standard
 01-1005-04 # 4

01-1006-4L # 4L
 01-1006-4XL # 4XL

01-1007-4L # 4L
 01-1007-4XL # 4XL
 angled

01-1008-07 # 7

01-1009-07 # 7K

Collin
 01-1010-08

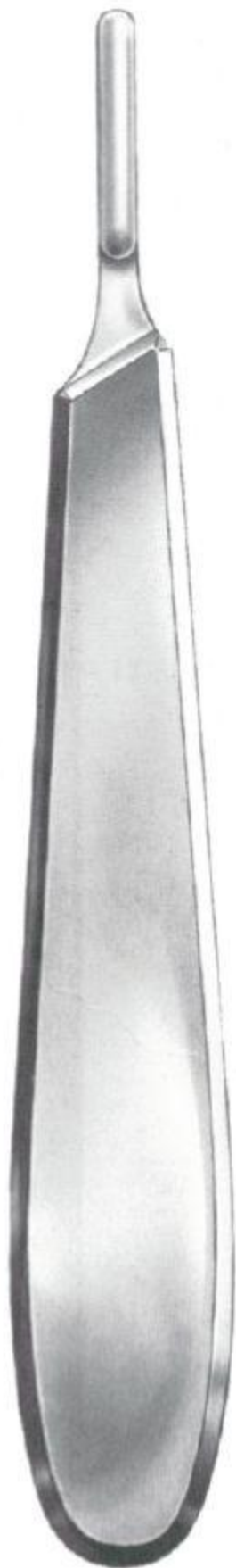

Collin
01-1011-09
Hollow, No. 9



Super
01-1012-10
Hollow, No. 10



01-1013-00
Hollow, round



01-1014-00
Plastics



17cm/6¾"



Fig. 1

01-1015-01



Fig. 2

01-1015-02



Fig. 3

01-1015-03



Fig. 4

01-1015-04



Fig. 5

01-1015-05



Fig. 6

01-1015-06



Fig. 7

01-1015-07



Fig. 8

01-1015-08



Fig. 9

01-1015-09



Fig. 10

01-1015-10



Dissecting Knives ●— EN
 Anatomische Skalpelte ●— DE
 Bisturías para disección anatómica ●— ES



Dieffenbach
 17cm/6¾"



Fig. 1
 01-1019-01



Fig. 2
 01-1019-02



Fig. 3
 01-1019-03



Fig. 4
 01-1019-04



Fig. 5
 01-1019-05



Fig. 6
 01-1019-06



Fig. 7
 01-1019-07



Fig. 8
 01-1019-08



Fig. 9
 01-1019-09



Fig. 15
 01-1019-15



Fig. 16
 01-1019-16



Bergmann
01-1020-01
14.5cm/5¾"



Fig. 2 01-1020-02
Fig. 3 01-1020-03
Fig. 4 01-1020-04



Dieffenbach
13cm/5¼"

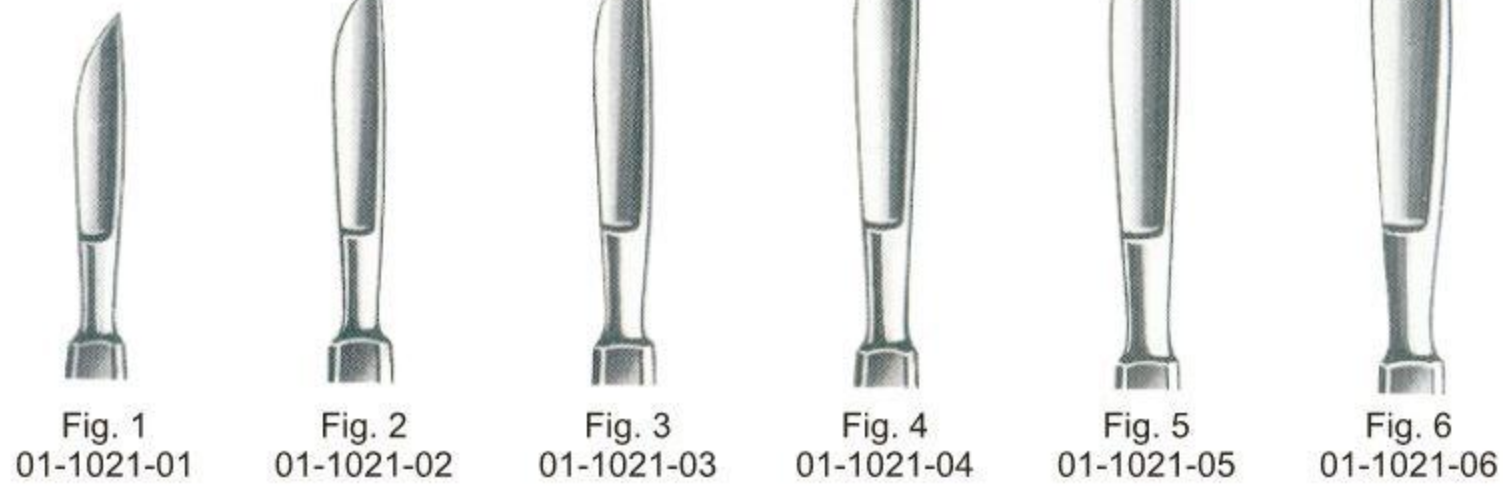

Fig. 1 01-1021-01
Fig. 2 01-1021-02
Fig. 3 01-1021-03
Fig. 4 01-1021-04
Fig. 5 01-1021-05
Fig. 6 01-1021-06



Fig. 7 01-1021-07
Fig. 8 01-1021-08
Fig. 9 01-1021-09
Fig. 10 01-1021-10
Fig. 11 01-1021-11
Fig. 12 01-1021-12



Simon
20cm/8"



Fig. 1
01-1022-01



Fig. 2
01-1022-02



Fig. 3
01-1022-03



Fig. 4
01-1022-04



Ulrich
22.5 cm/9"



Fig. 1
01-1023-01



Fig. 2
01-1023-02



Fig. 3
01-1023-03



Simon
23.5 cm/9 1/4 "



Fig. 1
01-1024-01



Fig. 2
01-1024-02



Fig. 3
01-1024-03



Fig. 4
01-1024-04



01-1025-01
7.5 cm/3"

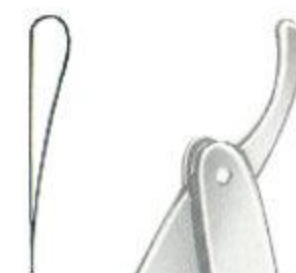

01-1026-02
8 cm/3 1/4 "

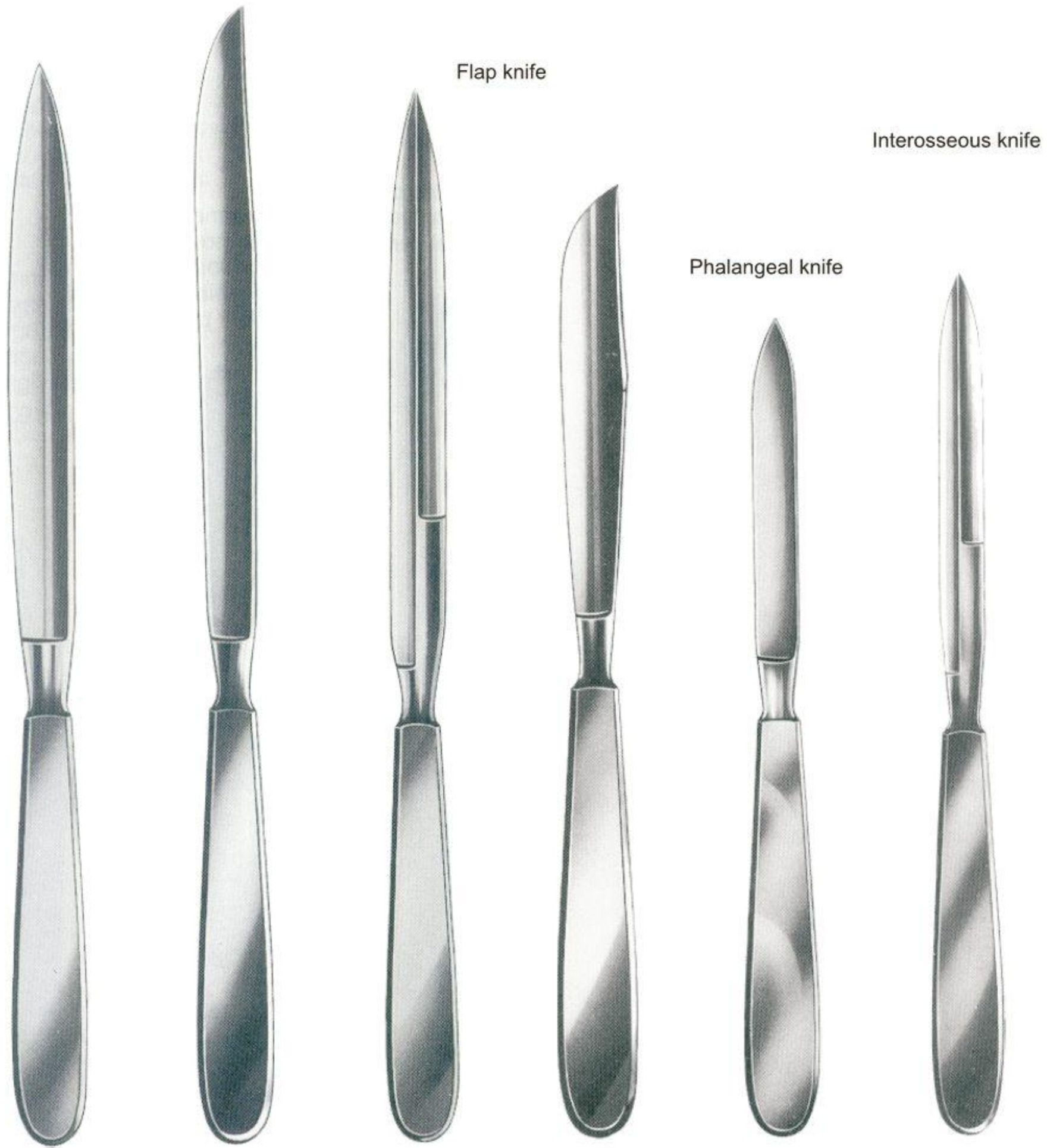

Length of blades		Liston	Catlin	Langenbeck		
cm	in					
9.5	3 3/4				01-1031-09	
11.0	4 1/2					01-1032-11
12.0	4 3/4				01-1030-12	
13.0	5	01-1027-13				
15.0	6					
16.0	6 1/4	01-1027-16		01-1029-16		
17.0	6 3/4		01-1028-17			
19.0	7 1/2	01-1027-19		01-1029-19		
20.0	8		01-1028-20			
22.0	8 3/4	01-1027-22		01-1029-22		



Langenbeck
 01-1033-01
 18 cm/7"

01-1033-02

Virchow

Length of blades

8.5 cm/3 1/2"			01-1037-08
11.0 cm/4 1/2"		01-1035-11	01-1036-11
14.0 cm/5 1/2"		01-1035-14	
16.0 cm/6 1/4"	01-1034-16		
17.0 cm/6 3/4"		01-1035-17	
20.0 cm/8"	01-1034-20		
24.0 cm/9 1/2"	01-1034-24		

Autopsy knives
Length of blades
19.5cm/7 ¾"

Length of blades
9.5cm/3 ¾"

Cartilage knives

Wooden handle

Metal handle

Virchow
01-1038-09

01-1039-19

01-1040-01

01-1041-01

Dissecting Knives ●— EN
 Anatomische Skalpelle ●— DE
 Bisturías para disección anatómica ●— ES



Troutman-Chris
 01-1042-09
 9cm/3 1/2"



Troutman-Chris
 01-1043-09
 9cm/3 1/2"



01-1044-11
 11cm/4 1/2"



Castroviejo
 01-1045-13
 13cm/5 1/4"



01-1046-18
 18cm/7"



Skull Breaker

01-1047-14
14 cm/5½"

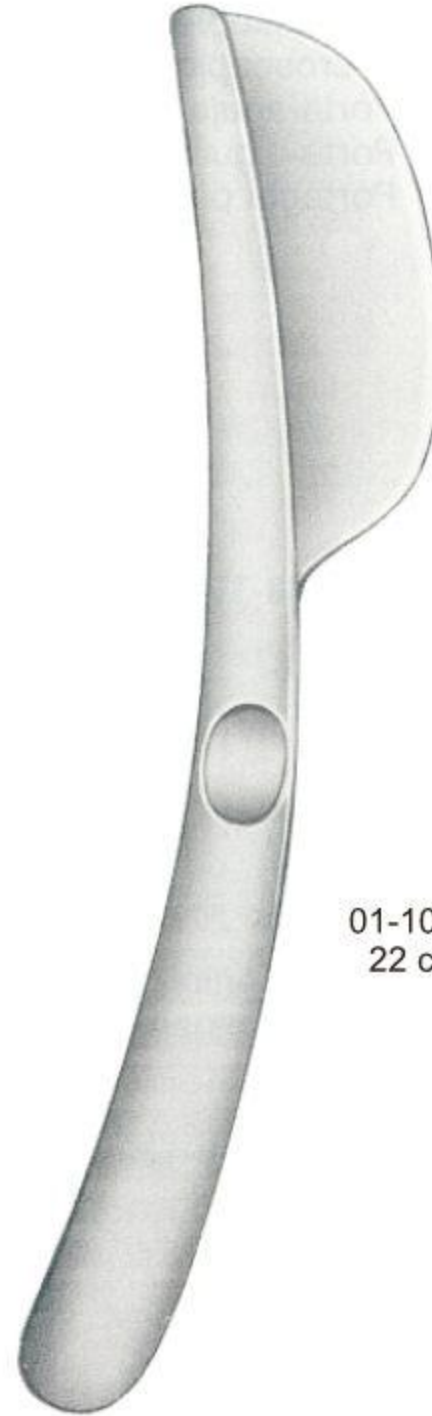

Rachiome

01-1048-22
22 cm/8¾"



23 mm

Osteotome

01-1049-13
13 cm/5"

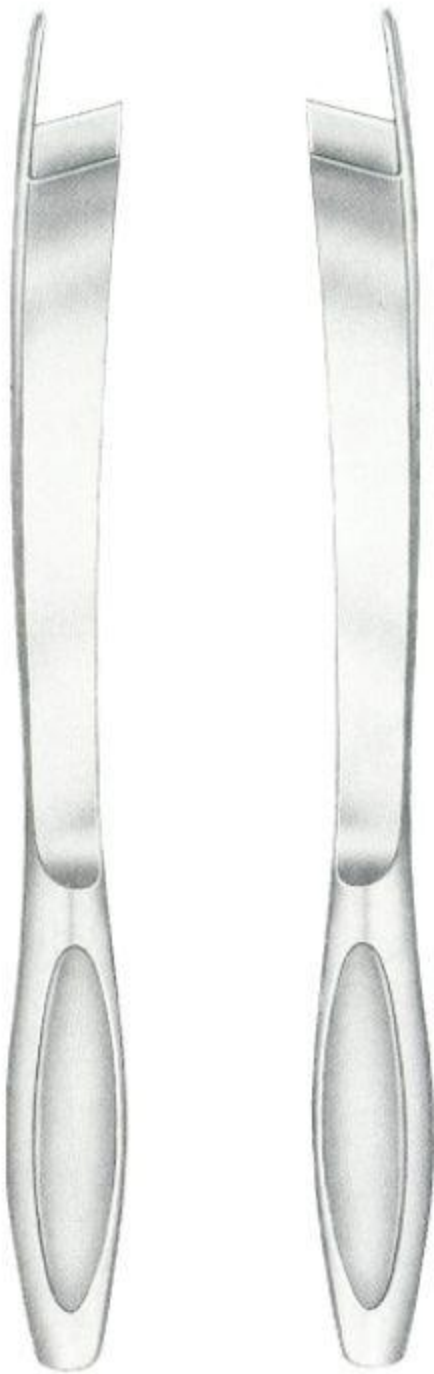

Brunetti
01-1050-28

Brunetti
01-1051-28

28.5 cm/11¼"

Muscle hooks



01-1052-06
6.5 cm/2½"



01-1053-07
7 cm/2¾"



01-1054-01

Microscopic needles



01-1055-13
13 cm/5"



01-1056-13
13 cm/5"



Microscopic needle holder

Kolle
01-1057-24
24 cm/ 9½"



Loop for needle holder

01-1058-06
6 cm/2 ¼"

Post mortem needles

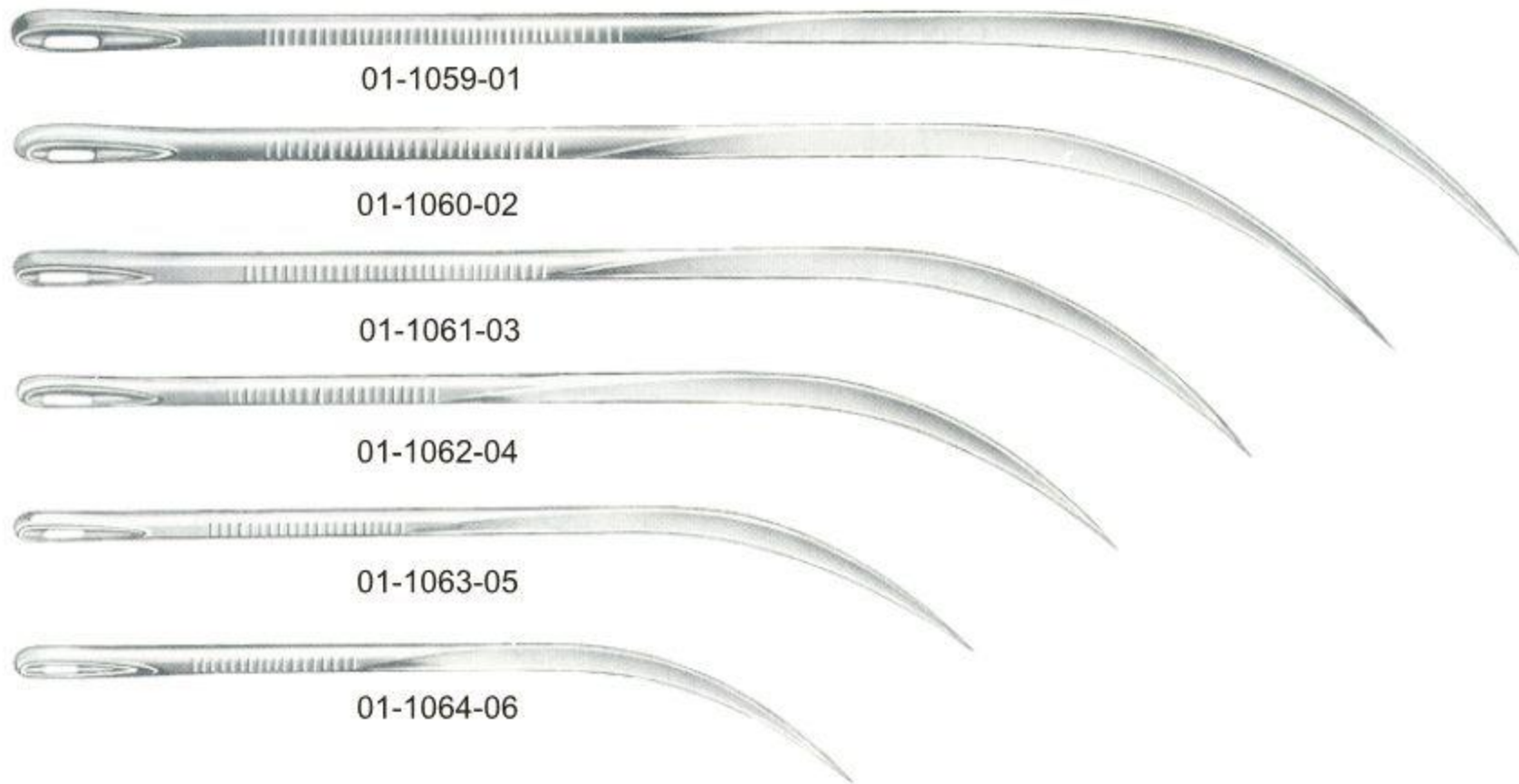

01-1059-01

01-1060-02

01-1061-03

01-1062-04

01-1063-05

01-1064-06

EN **Diagnostics**

DE **Diagnostik**

ES **Diagnóstico**

Page 15 to 20





Taylor
02-1101-18 18.0cm
02-1101-20 20.0cm



Dejerine
02-1102-20 20.0cm



Dejerine
02-1103-21 21.0cm
02-1103-35 35.0cm



Neuro-Duoflex
02-1104-22 22.0cm

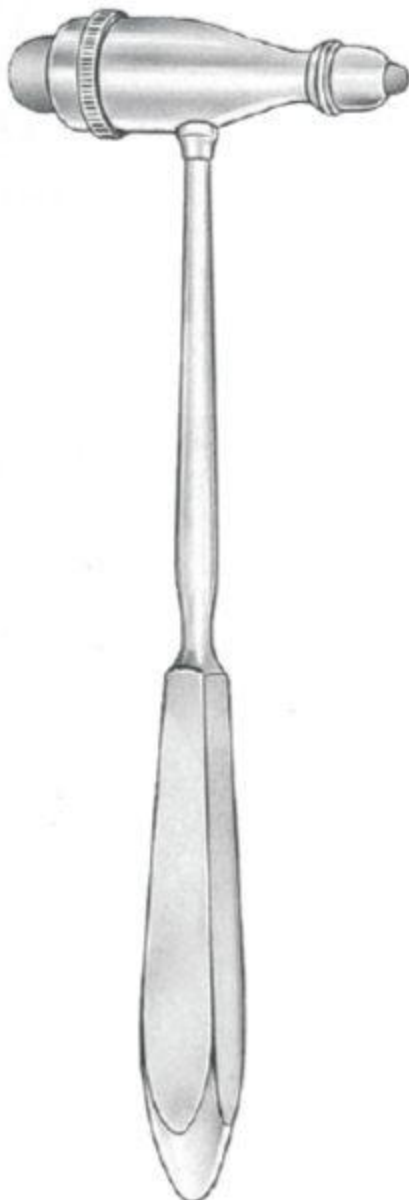

Troemner
02-1105-24 24.0cm

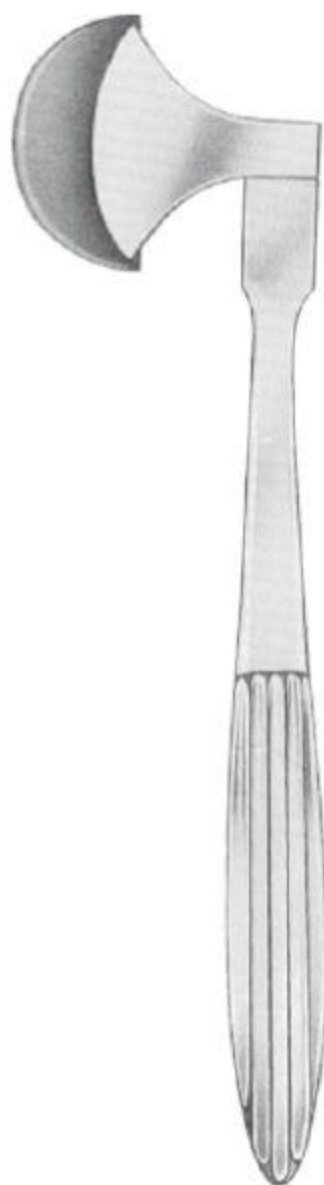

Berliner
02-1106-20
20cm/8"



Buck
02-1107-18 18.0cm



Buck (Telescopic)
02-1108-18 18.0cm

Percussion Hammers ● EN
 Perkussionshämmer ● DE
 Martillos de percusión ● ES



Traube
 02-1109-16
 16 cm/6 1/4"



Troemner
 02-1110-21
 21cm/8 1/4"



Divers-Duoflex
 02-1111-22
 22 cm/8 3/4"



Babinsky
 02-1112-22 22 cm/8 3/4"
 02-1112-25 25 cm/10"



Rabiner
 02-1113-23
 23 cm/9 1/4"



National Hospital
 02-1114-33
 33 cm/13"



Queen Square
 02-1115-26
 26 cm/10 1/4"



Pinard
02-1116-18 18.0cm
(wooden)



Pinard
02-1117-15 15.0cm
(plastic)



Pinard
02-1118-15 15.0cm
(aluminum)

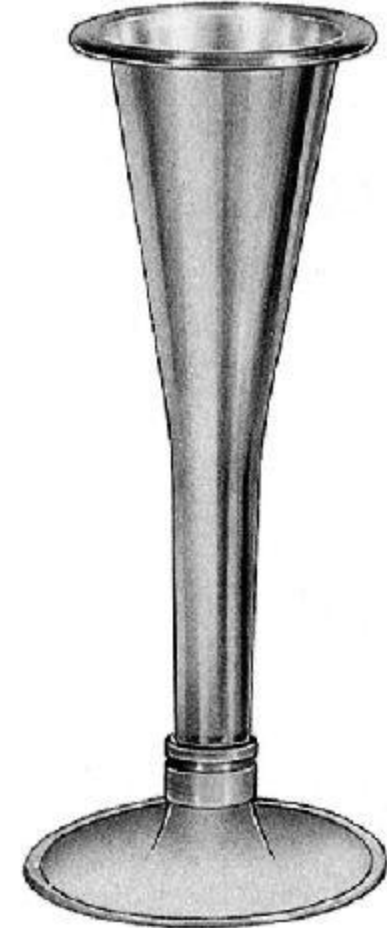

Pinard
02-1119-15 15.0cm
(aluminum)



Aly
02-1120-17
17cm/6¾"



Wartenberg
02-1121-19
19cm/7½"



Weber
02-1122-09
9cm/3½"



02-1123-15 15.0cm
02-1123-30 30.0cm
02-1123-60 60.0cm

Goniometer



Moltgen
02-1124-00

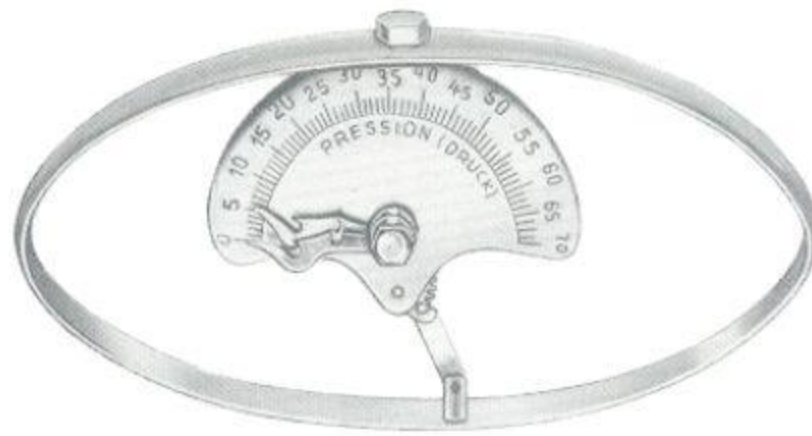

Collin
for children 02-1125-01 for adults 02-1125-02



Townley
02-1126-10
10cm/4"

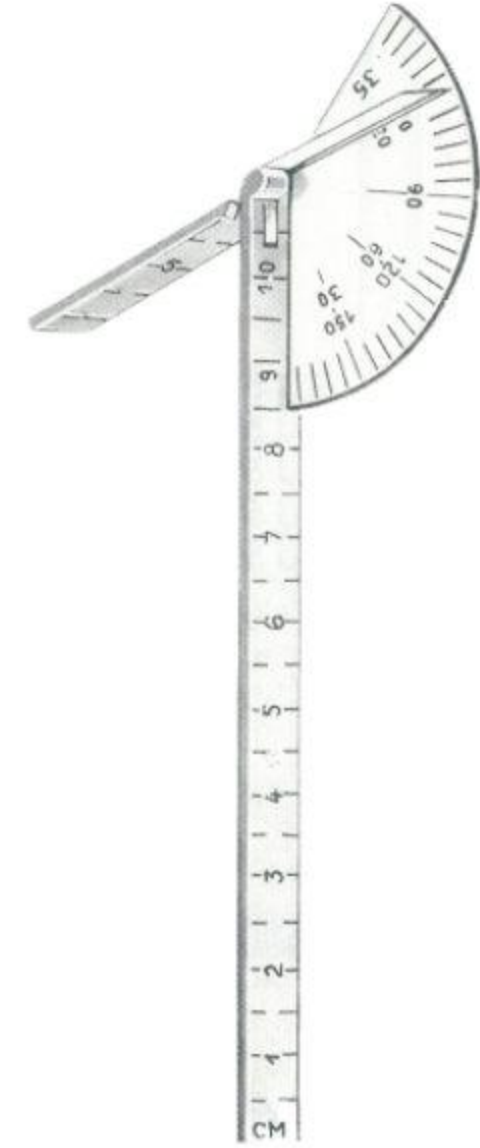

Caroll
02-1127-14
14cm/5 1/2"



Ford
02-1128-00

Chest piece only
02-1128-01



Dual
02-1129-00

Chest piece only
02-1129-01



02-1130-00



02-1131-00

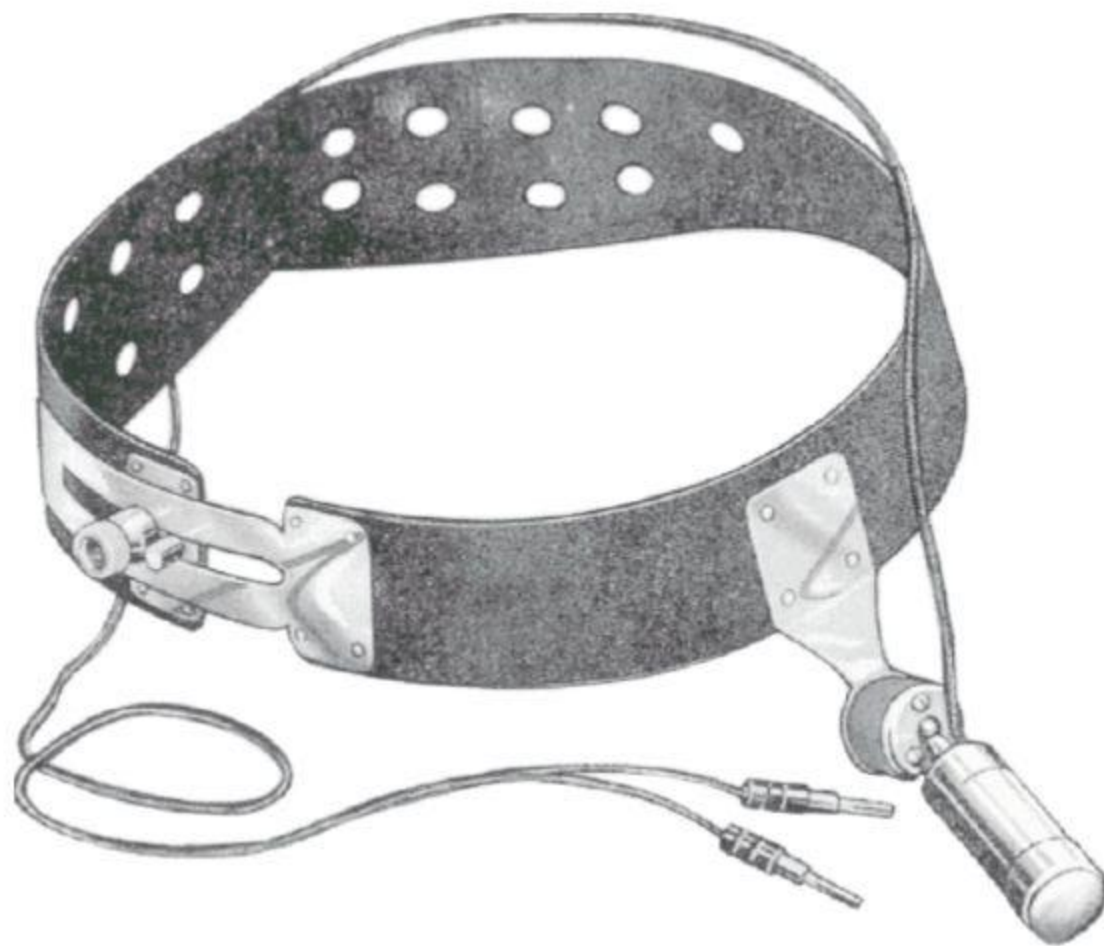

02-1132-00

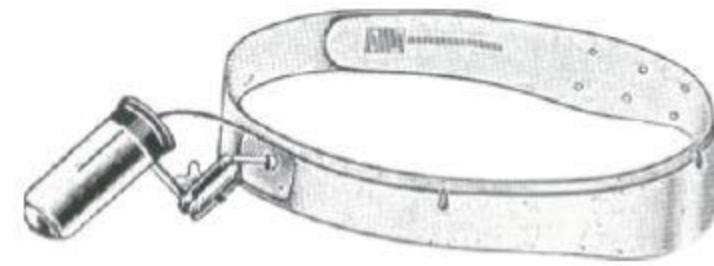

Jansen
02-1133-00



02-1134-00
 Otoscope set in Case



02-1135-00
 Otoscope set in Pouch



02-1136-00
 Ophthalmoscope set



02-1137-00
 Ophthalmoscope and Otoscope set



02-1138-00
 Complete ENT set

EN Trocars, Vaccination

DE Impfen, Punktion

ES Vacunación, Punción

Page 21 to 27





Nelson

Ø mm	21cm/8¼"
7.5	03-1201-07
9.0	03-1201-09
10.5	03-1201-10
12.0	03-1201-12



Ochsner

Ø mm	14.5cm/5½"
4.0	03-1202-40
4.6	03-1202-46
5.5	03-1202-55
6.5	03-1202-65

Ø5.5 mm



Krause
 03-1203-15
 15cm/6"

Ø2.25 mm

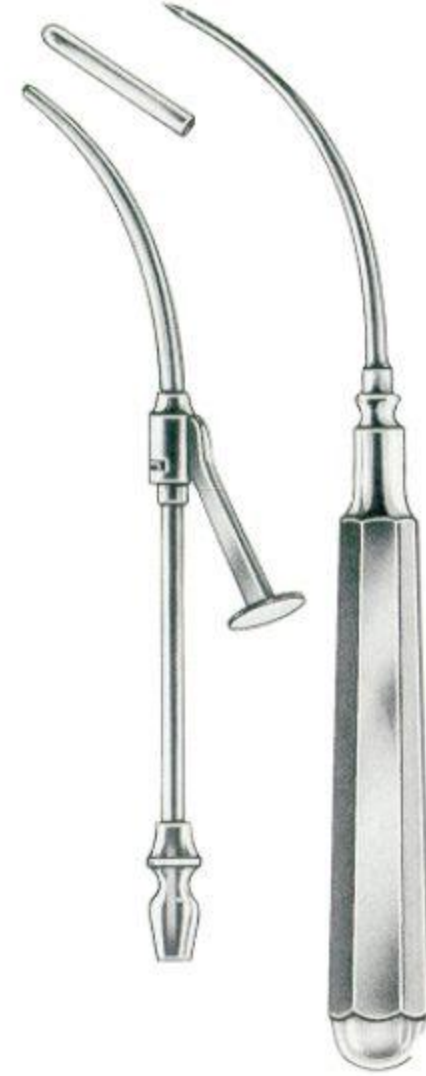

Coakley
 03-1204-16
 16cm/6¼"

Ø1.8 mm



Lichtwitz
 03-1205-19
 19cm/7½"

Ø3 mm



Douglas
 03-1206-11
 11.5 cm/4½"



03-1207-11
 11.5 cm/4½"



Pierce

Ø mm	
3.0	03-1208-03
4.0	03-1208-04
5.0	03-1208-05

Ø 2 mm



Landau
 03-1209-16
 16cm/6¼"

Ø 2 mm



Landau
 03-1210-19
 19cm/7½"

Ø 13.5mm



Peau
 03-1211-16
 16cm/6¼"

Ø 8 mm



Buelau
 03-1212-24
 24cm/9½"

Brain Suction Tubes



∅
2.0 mm 03-1213-20
2.5 mm 03-1213-25
3.0 mm 03-1213-30
13cm/5"

Frazier



∅
1.5 mm 03-1214-15
2.0 mm 03-1214-20
2.5 mm 03-1214-25
3.0 mm 03-1214-30
19.5cm/7¾"

Plester



Adson
03-1215-02
21cm/8¼"
∅4 mm

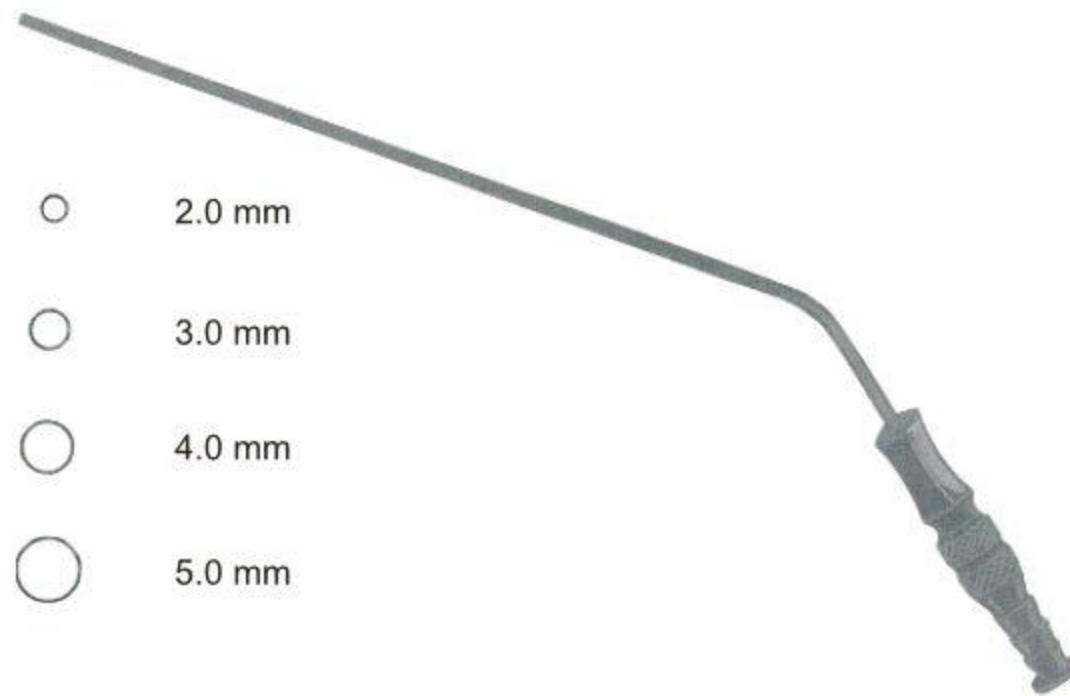

- 2.0 mm
- 3.0 mm
- 4.0 mm
- 5.0 mm

∅ malleable, black
2 mm 03-1216-02
3 mm 03-1216-03
4 mm 03-1216-04
5 mm 03-1216-05
19.5cm/7¾"

Suction Tubes ●— EN
 Saugrohre ●— DE
 Tubos de aspiración ●— ES

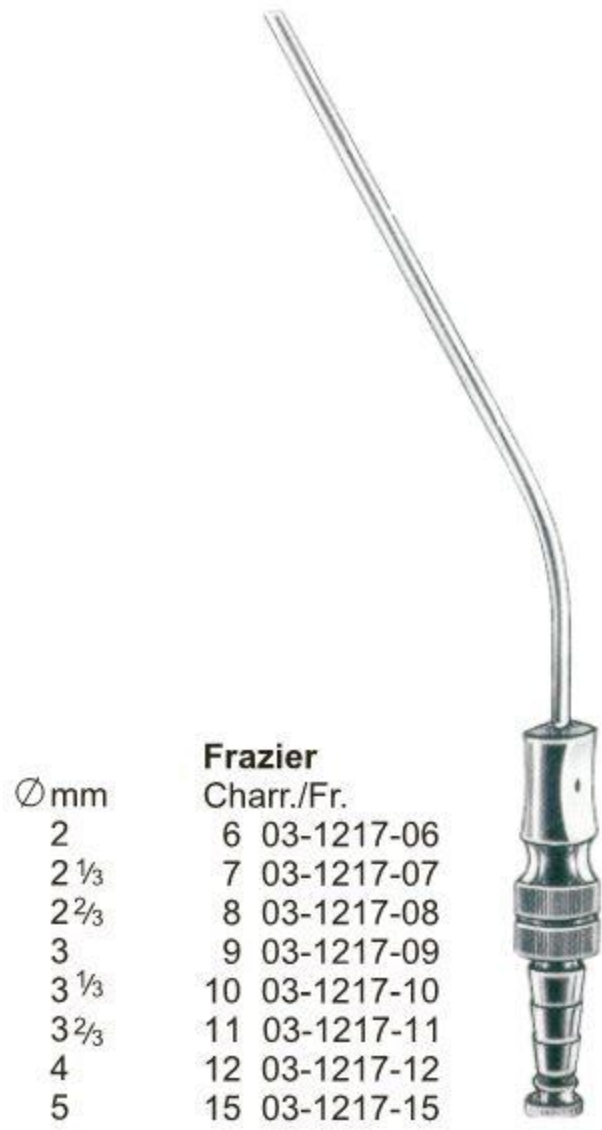

Ømm	Frazier Charr./Fr.
2	6 03-1217-06
2 1/3	7 03-1217-07
2 2/3	8 03-1217-08
3	9 03-1217-09
3 1/3	10 03-1217-10
3 2/3	11 03-1217-11
4	12 03-1217-12
5	15 03-1217-15



Ømm	Ferguson Charr./Fr.
2	6 03-1218-06
2 1/3	7 03-1218-07
2 2/3	8 03-1218-08
3	9 03-1218-09
3 1/3	10 03-1218-10
3 2/3	11 03-1218-11
4	12 03-1218-12

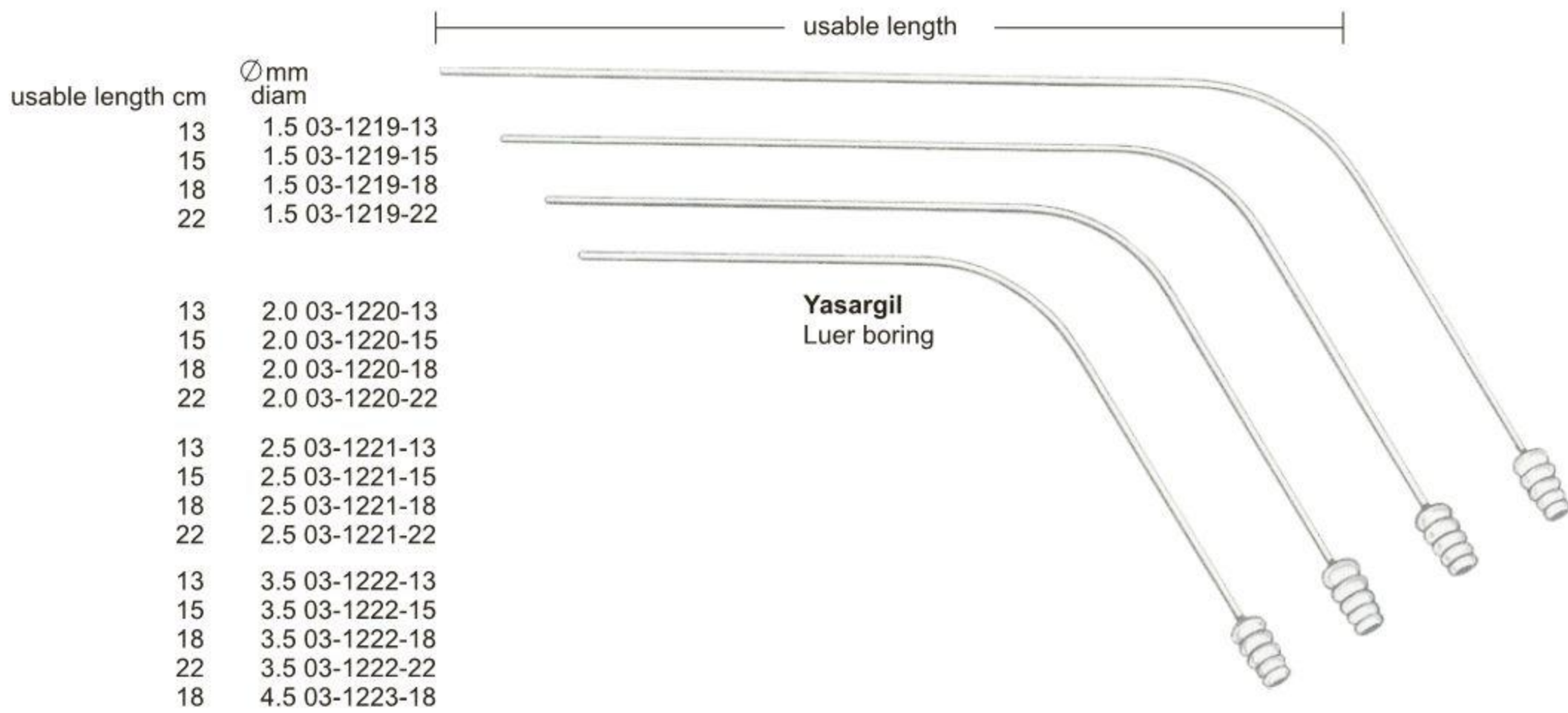

usable length cm	Ømm diam
13	1.5 03-1219-13
15	1.5 03-1219-15
18	1.5 03-1219-18
22	1.5 03-1219-22
13	2.0 03-1220-13
15	2.0 03-1220-15
18	2.0 03-1220-18
22	2.0 03-1220-22
13	2.5 03-1221-13
15	2.5 03-1221-15
18	2.5 03-1221-18
22	2.5 03-1221-22
13	3.5 03-1222-13
15	3.5 03-1222-15
18	3.5 03-1222-18
22	3.5 03-1222-22
18	4.5 03-1223-18

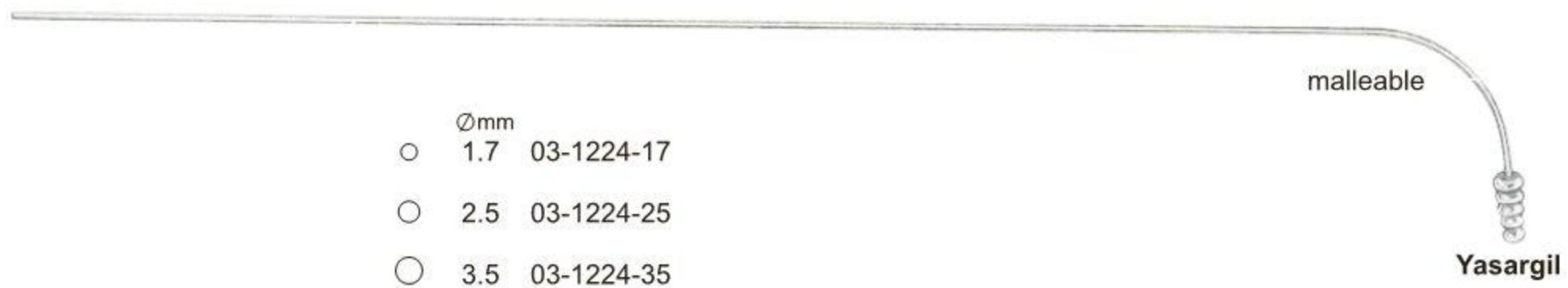

Ømm	
○ 1.7	03-1224-17
○ 2.5	03-1224-25
○ 3.5	03-1224-35



Yankauer
03-1225-27
27cm/10½"



Yankauer
03-1226-27
27cm/10½"

with stopcock



Yankauer
03-1227-01



Fig. 0
03-1227-10



Fig. 1
03-1227-11



Fig. 2
03-1227-12



Fig. 3
03-1227-13

03-1227-50 SET



∅ 6 mm
round

Nuboer
03-1228-01
21cm/8¼"



6 mm
ovale

Nuboer
03-1229-02
21cm/8¼"



∅ 6 mm

Andrew-Pynchon
03-1230-23
23 cm/9"

Suction Tubes ●— EN
 Saugrohre ●— DE
 Tubos de aspiración ●— ES

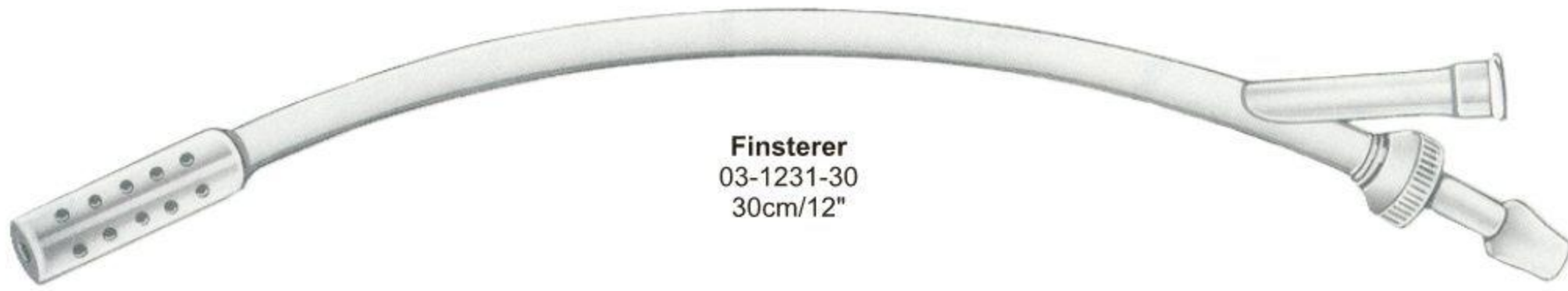

Finsterer
 03-1231-30
 30cm/12"

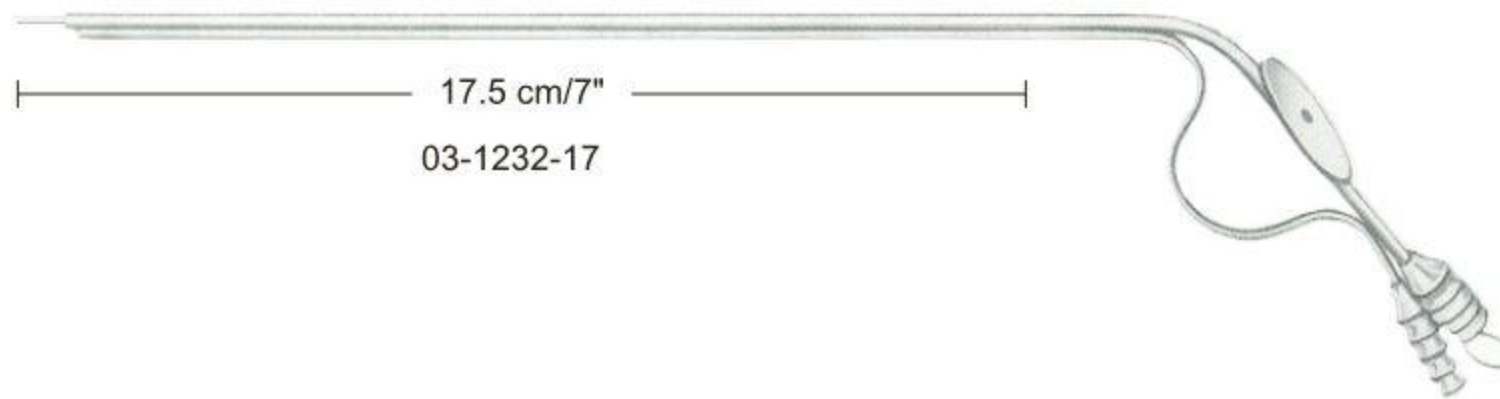

17.5 cm/7"
 03-1232-17

Ø 6 mm



Baby-Poole
 03-1233-20
 20cm/8"

Ø 10 mm



Poole
 03-1234-22
 22cm/8¾"

Ø 8 mm



Poole
 03-1235-22
 22cm/8¾"

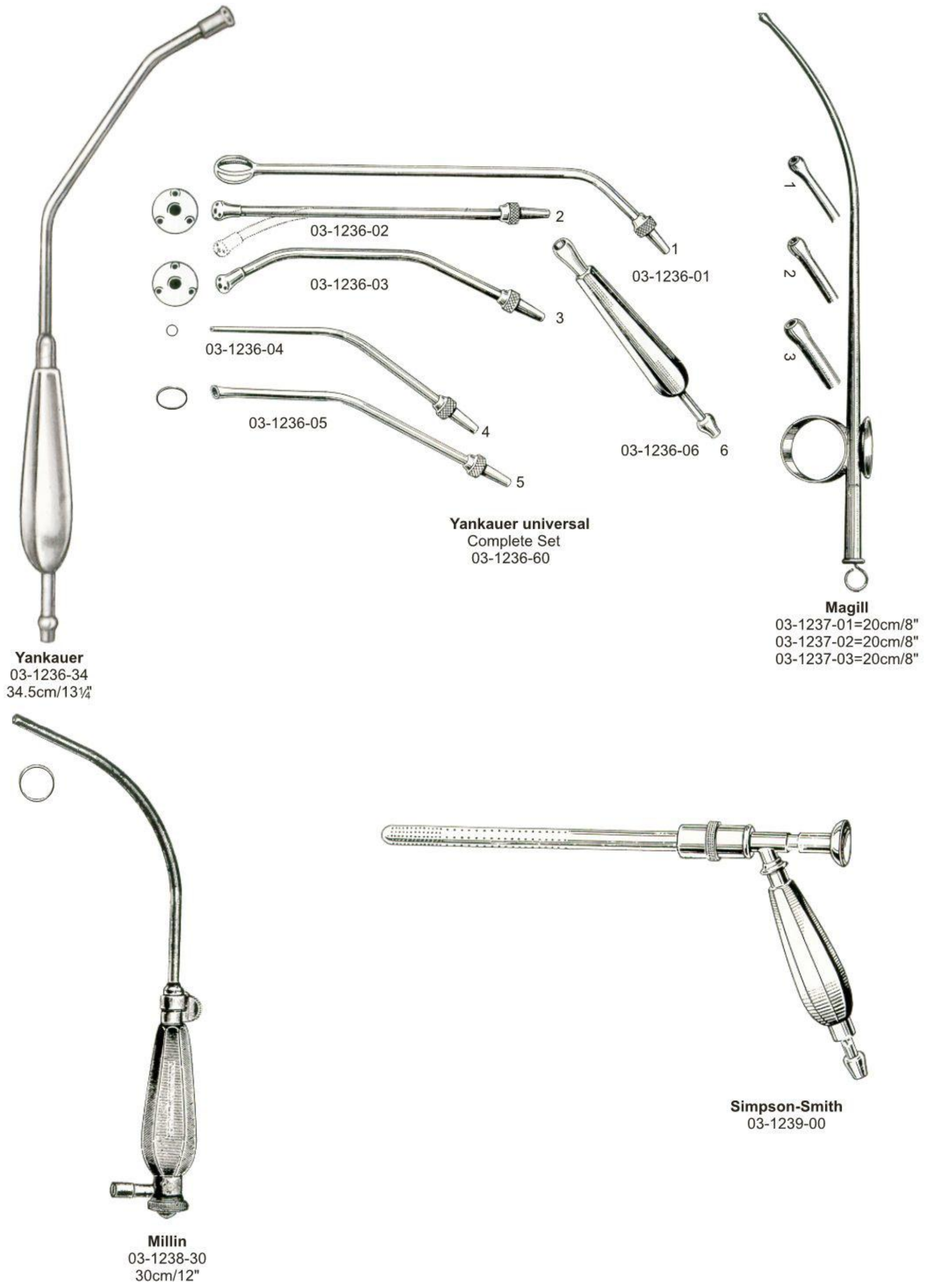

EN Anaesthesia

DE Narkose

ES Anestesia

Page 28 to 36





Miller
04-1301-30
04-1301-40

04-1301-30
Laryngoscope Set
Consisting of:
04-1301-00 Battery Handle (without batteries)
04-1301-11 McIntosh blade, Fig 1
04-1301-12 ditto, Fig 2
04-1301-13 ditto, Fig 3

04-1301-40
Laryngoscope Set
Consisting of:
04-1301-00 Battery Handle (without batteries)
04-1301-11 McIntosh blade, Fig 1
04-1301-12 McIntosh blade, Fig 2
04-1301-13 McIntosh blade, Fig 3
04-1301-14 McIntosh blade, Fig 4

McIntosh Laryngoscope Blades
04-1301-10 Fig 0, Working length 55mm, baby's
04-1301-11 Fig 1, Working length 75mm, children's
04-1301-12 Fig 2, Working length 90mm, adolescent's
04-1301-13 Fig 3, Working length 110mm, women's
04-1301-14 Fig 4, Working length 135mm, men's



04-1301-10
Fig. 0
55 mm



04-1301-11
Fig. 1

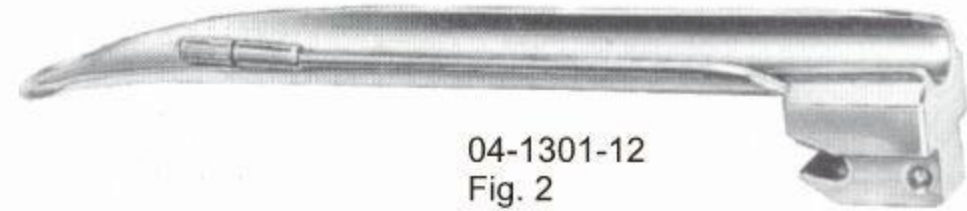

04-1301-12
Fig. 2



04-1301-13
Fig. 3



04-1301-14
Fig. 4

Laryngoscopes ●— EN
 Laryngoskope ●— DE
 Laringoscopios ●— ES



McIntosh
 04-1302-30
 04-1302-40

04-1302-30
 Laryngoscope Set
 Consisting of:
 04-1302-00 Battery Handle (without batteries)
 04-1302-11 McIntosh blade, Fig 1
 04-1302-12 ditto, Fig 2
 04-1302-13 ditto, Fig 3



04-1302-10

04-1302-11

04-1302-40
 Laryngoscope Set
 Consisting of:
 04-1302-00 Battery Handle (without batteries)
 04-1302-11 McIntosh blade, Fig 1
 04-1302-12 McIntosh blade, Fig 2
 04-1302-13 McIntosh blade, Fig 3
 04-1302-14 McIntosh blade, Fig 4



04-1302-12



04-1302-13



04-1302-14

McIntosh Laryngoscope Blades
 04-1302-10 Fig 0, Working length 55mm, baby's
 04-1302-11 Fig 1, Working length 75mm, children's
 04-1302-12 Fig 2, Working length 90mm, adolescent's
 04-1302-13 Fig 3, Working length 110mm, women's
 04-1302-14 Fig 4, Working length 135mm, men's



Foregger
04-1303-30
04-1303-40

04-1303-30
Laryngoscope Set
Consisting of:
04-1303-00 Battery Handle (without batteries)
04-1303-12 Foregger Blade, Fig 2
04-1303-13 ditto, Fig 3
04-1303-14 ditto, Fig 4

04-1303-40
Laryngoscope Set
Consisting of:
04-1303-00 Battery Handle (Without batteries)
04-1303-11 Foregger Blade, Fig 1
04-1303-12 Foregger Blade, Fig 2
04-1303-13 Foregger Blade, Fig 3
04-1303-14 Foregger Blade, Fig 4



04-1303-11



04-1303-12



04-1303-13



04-1303-14

Foregger Laryngoscope Blade,
04-1303-11 Fig 1, working length 70mm, children's
04-1303-12 Fig 2, working length 90mm, adolescent's
04-1303-13 Fig 3, working length 110mm, women's
04-1303-14 Fig 4, working length 135mm, men's

Laryngoscopes ●— EN
 Laryngoskope ●— DE
 Laringoscopios ●— ES



04-1304-30
 Laryngoscope Set
 Consisting of:
 04-1304-00 Battery Handle (without batteries)
 04-1304-12 Guedel-Negus Blade, Fig 2
 04-1304-13 ditto, Fig 3
 04-1304-14 ditto, Fig 4

Guedel-Negus
 04-1304-30
 04-1304-40

04-1304-40
 Laryngoscope Set
 Consisting of:
 04-1304-00 Battery Handle (without batteries)
 04-1304-11 Guedel-Negus Blade, Fig 1
 04-1304-12 Guedel-Negus Blade, Fig 2
 04-1304-13 Guedel-Negus Blade, Fig 3
 04-1304-14 Guedel-Negus Blade, Fig 4



04-1304-11



04-1304-12



04-1304-13



04-1304-14

Guedel Laryngoscope Blades
 04-1304-11 Fig 1, working length 70mm, children's
 04-1304-12 Fig 2, working length 90mm, adolescent's
 04-1304-13 Fig 3, working length 110mm, women's
 04-1304-14 Fig 4, working length 135mm, men's

COLD LIGHT LARYNGOSCOPES



04-1305-00
handle with lamp

McINTOSH
with fiberoptic



04-1305-50
set with 5 blades

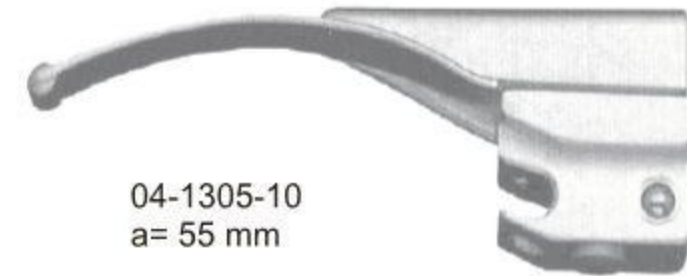
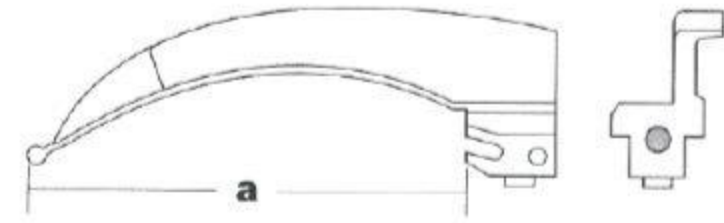

04-1305-10
a= 55 mm

Fig. 0



04-1305-11
a= 70 mm

Fig. 1

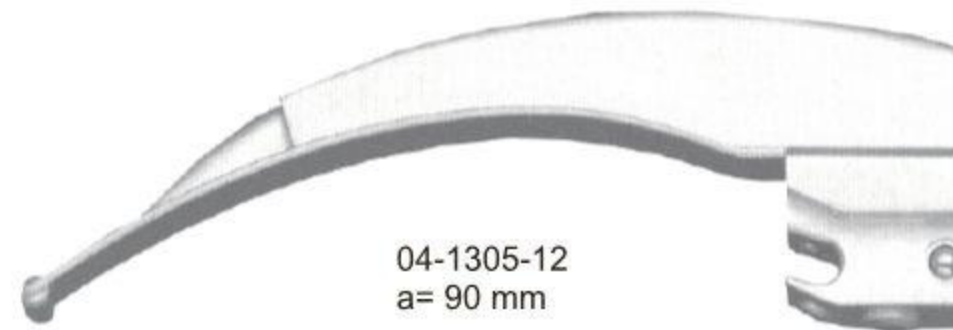

04-1305-12
a= 90 mm

Fig. 2

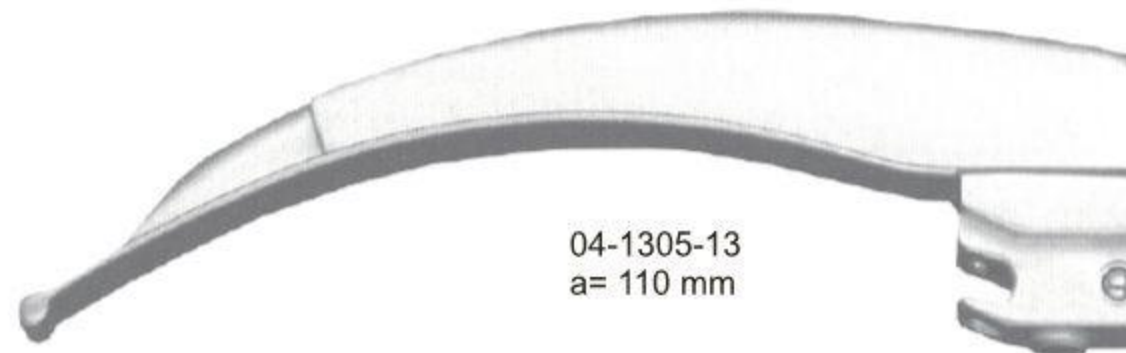

04-1305-13
a= 110 mm

Fig. 3

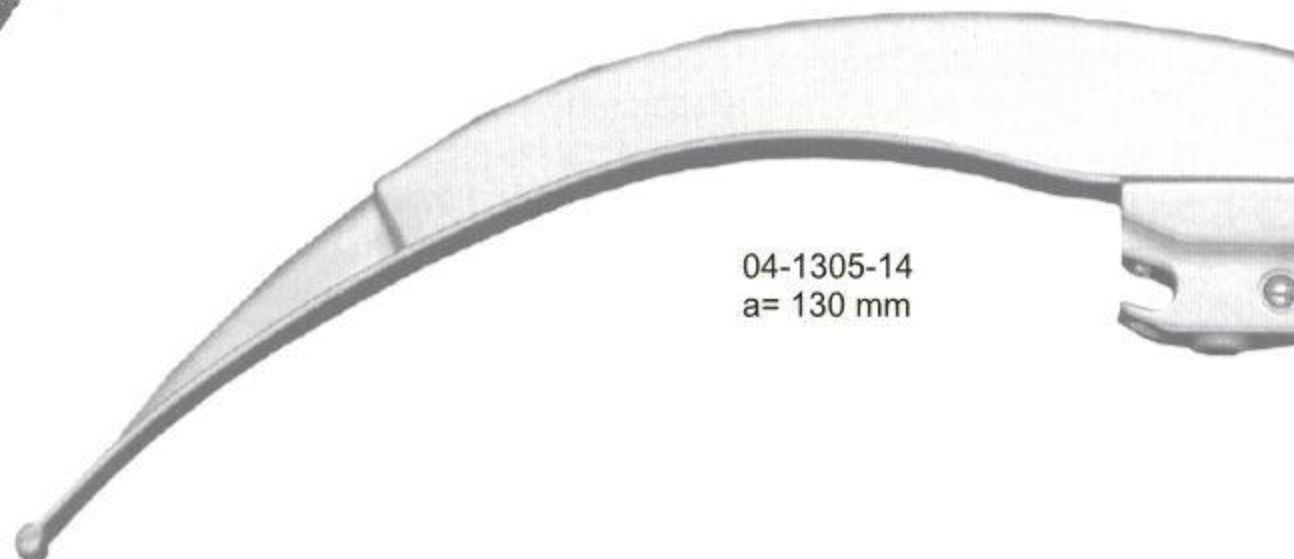

04-1305-14
a= 130 mm

Fig. 4

COLD LIGHT LARYNGOSCOPES



04-1306-50
 set with 5 blades



04-1306-00
 handle with lamp



04-1306-10
 a= 55 mm

Fig. 0

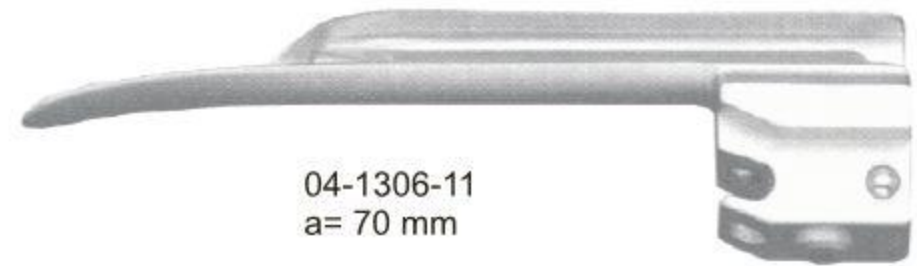

04-1306-11
 a= 70 mm

Fig. 1

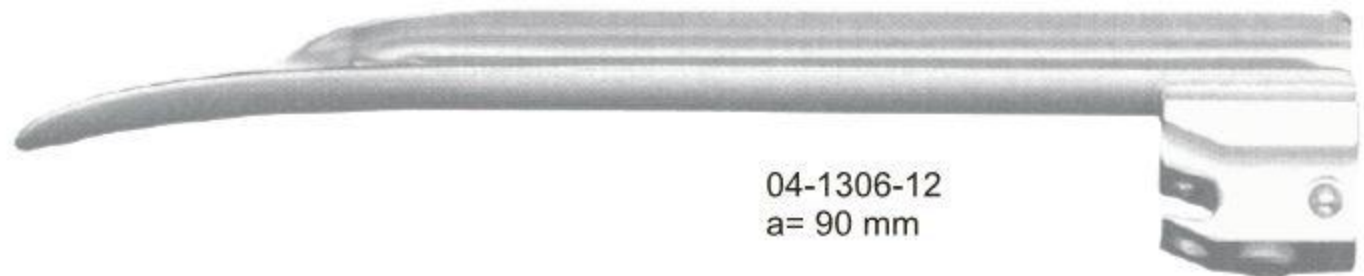

04-1306-12
 a= 90 mm

Fig.2



04-1306-13
 a= 110 mm

Fig. 3



04-1306-14
 a= 130 mm

Fig.4



Working length 55 mm
04-1307-10

Working length 80 mm
04-1307-11

Miller-Baby
04-1307-20

04-1307-20
Laryngoscope Set, Baby and Infant,
consisting of :
04-1307-00 Battery Handle (without battery)
04-1307-10 Miller-baby blade, Fig 0
working length 55 mm
04-1307-11 ditto, Fig 1 working length 80 mm



Negus
18 mm dia
04-1308-00



Conventional Handles

	Size	Batteries
04-1309-01	Medium/Standard	2C
04-1309-02	Small/Penlight	2AA
04-1309-03	Stubby	2AA
04-1309-04	Large	2D



Fiber Optic Handles

	Size	Batteries
04-1310-01	Medium/Standard	2C
04-1310-02	Small/Penlight	2AA
04-1310-03	Stubby	2AA
04-1310-04	Large	2D



Schimmelbusch
 04-1311-01 Child
 04-1311-02 Adult



Magill
 04-1312-15 15 cm/6" Infant
 04-1312-20 20 cm/8" Child
 04-1312-25 25 cm/10" Adult



Yankauer
 04-1313-01 Child
 04-1313-02 Adult



Connel
 04-1314-01 Child
 04-1314-02 Adult



04-1315-01



Lumbard-Mayo
 04-1315-02



04-1315-03

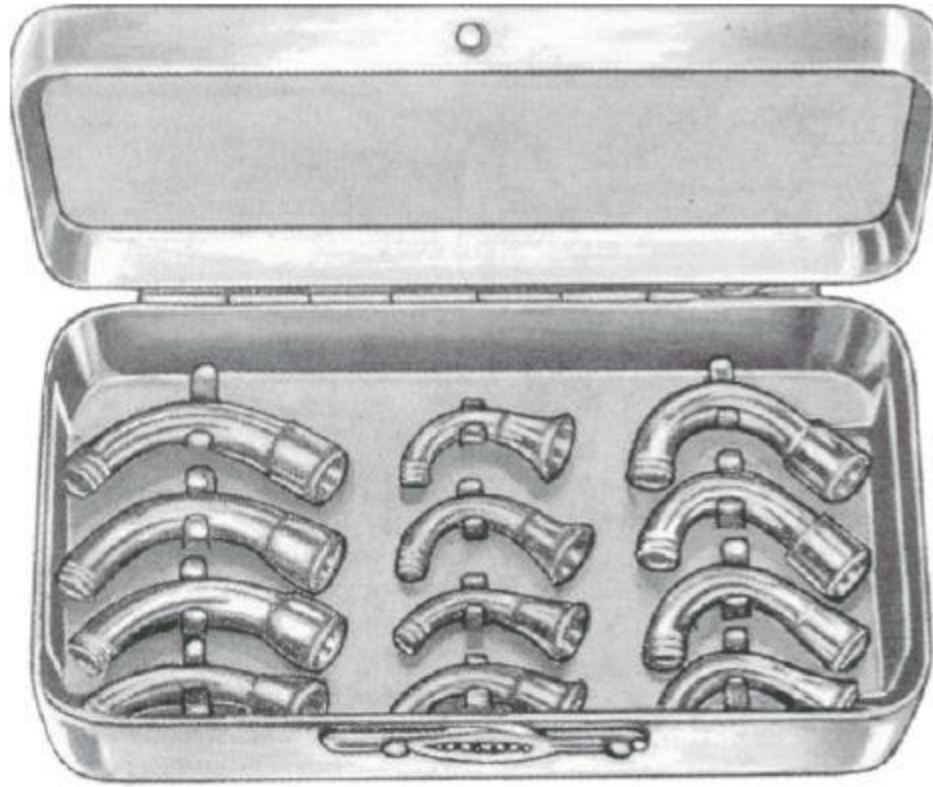

Magill
Connection Set
04-1316-00



Magill (Nasal)	mm dia
04-1316-01	5.5
04-1316-02	6.5
04-1316-03	7.5
04-1316-04	8.0
04-1316-05	8.5
04-1316-06	9.5
04-1316-07	10.0
04-1316-08	10.5



Magill (Aural)	mm dia
04-1317-01	5.5
04-1317-02	6.5
04-1317-03	7.5
04-1317-04	8.0
04-1317-05	8.5
04-1317-06	9.5
04-1317-07	10.0
04-1317-08	10.5



Cobb
04-1318-01 Small
04-1318-02 Medium
04-1318-03 Large

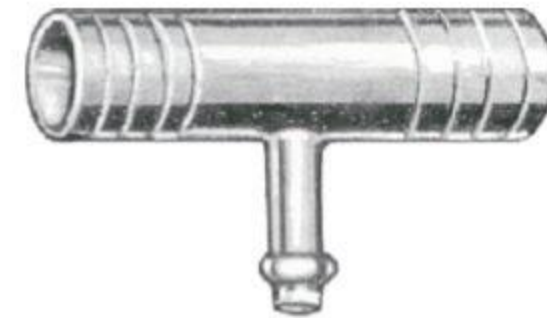

Ayre
04-1319-01 Small
04-1319-02 Medium
04-1319-03 Large

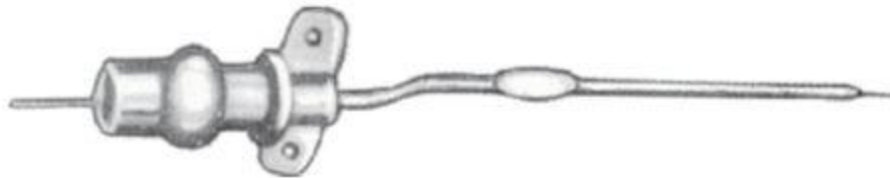

Hamilton Bailey
04-1320-01 Infant
04-1320-02 Child
04-1320-03 Adult



Mitchell
04-1321-18
04-1321-20
38 mm

EN Scissors

DE Scheren

ES Tijeras

Page 37 to 94



Straight Straight Straight

	Standard Fig. 1	Standard Fig. 2	Standard Fig. 3
10.0 cm/4"	05-1401-10	05-1402-10	05-1403-10
11.5 cm/4½"	05-1401-11	05-1402-11	05-1403-11
13.0 cm/5"	05-1401-13	05-1402-13	05-1403-13
14.5 cm/5¾"	05-1401-14	05-1402-14	05-1403-14
15.5 cm/6"	05-1401-15	05-1402-15	05-1403-15
16.0 cm/6¼"	05-1401-16	05-1402-16	05-1403-16
18.0 cm/7"	05-1401-18	05-1402-18	05-1403-18
20.0 cm/8"	05-1401-20	05-1402-20	05-1403-20

Curved Curved Curved

	Standard Fig. 1	Standard Fig. 2	Standard Fig. 3
10.0 cm/4"	05-1404-10	05-1405-10	05-1406-10
11.5 cm/4½"	05-1404-11	05-1405-11	05-1406-11
13.0 cm/5"	05-1404-13	05-1405-13	05-1406-13
14.5 cm/5¾"	05-1404-14	05-1405-14	05-1406-14
15.5 cm/6"	05-1404-15	05-1405-15	05-1406-15
16.0 cm/6¼"	05-1404-16	05-1405-16	05-1406-16
18.0 cm/7"	05-1404-18	05-1405-18	05-1406-18
20.0 cm/8"	05-1404-20	05-1405-20	05-1406-20



Graziol

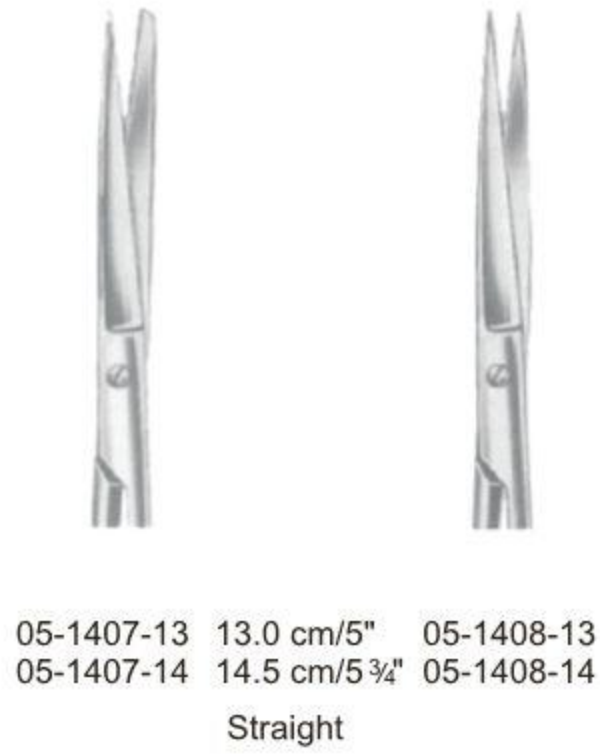

05-1407-13 13.0 cm/5" 05-1408-13
 05-1407-14 14.5 cm/5 3/4" 05-1408-14
 Straight



Graziol



05-1409-13 13.0 cm/5" 05-1410-13
 05-1409-14 14.5 cm/5 3/4" 05-1410-14
 Curved



Straight

05-1411-14



Curved

05-1412-14

Deaver

14.5cm/5 3/4"



Straight

05-1413-15



Curved

05-1414-15

Mixer

15.5cm/6"



Lexer
Straight
05-1415-16
16 cm/6¼"



Lexer
Curved
05-1416-16
16 cm/6¼"



Lexer-Fine
Straight
05-1417-16
16 cm/6¼"



Lexer-Fine
Curved
05-1418-16
16 cm/6¼"

Incision Scissors



05-1419-13 13.0 cm/5¼"
05-1419-14 14.5 cm/5¾"



05-1420-15
15.5 cm/6"



Richter
05-1421-14
14.5 cm/5¾"



Richter
05-1422-14
14.5 cm/5¾"



Mayo
Straight

05-1423-14 14.5 cm/5 3/4"
 05-1423-15 15.0 cm/6"
 05-1423-17 17.0 cm/6 3/4"
 05-1423-19 19.0 cm/7 1/2"
 05-1423-23 23.0 cm/9"



Mayo
Curved

05-1424-14 14.5 cm/5 3/4"
 05-1424-15 15.0 cm/6"
 05-1424-17 17.0 cm/6 3/4"
 05-1424-19 19.0 cm/7 1/2"
 05-1424-23 23.0 cm/9"



Mayo-Stille
Straight

05-1425-15 15 cm/6"
 05-1425-17 17 cm/6 3/4"
 05-1425-19 19 cm/7 1/2"
 05-1425-21 21 cm/8 1/4"



Mayo-Stille
Curved

05-1426-15 15 cm/6"
 05-1426-17 17 cm/6 3/4"
 05-1426-19 19 cm/7 1/2"
 05-1426-21 21 cm/8 1/4"



Fergusson
05-1427-18
18 cm/7"



New Suture
05-1428-14
14.5 cm/5 3/4"



Mayo-Noble
05-1429-17
17 cm/6 3/4"



Mayo-Noble
05-1430-17
17 cm/6 3/4"

Straight



Fig 1

Metzenbaum
05-1431-14
14.5 cm/5¾"



Fig 2

Metzenbaum
05-1432-14
14.5 cm/5¾"



Fig 3

Metzenbaum
05-1433-14
14.5 cm/5¾"

Straight



Baby-Metzenbaum
05-1434-11
11.5 cm/4½"

Curved



Baby-Metzenbaum
05-1435-11
11.5 cm/4½"



Metzenbaum-Fine
05-1436-14
14.5 cm/5¾"



Metzenbaum-Fine
05-1437-14
14.5 cm/5¾"



Metzenbaum-Fine
05-1438-14
14.5 cm/5¾"



Metzenbaum-Fine
05-1439-14
14.5 cm/5¾"

Straight



Metzenbaum-Fine
 18 cm/7" 05-1440-18
 20 cm/8" 05-1440-20
 23 cm/9" 05-1440-23
 25 cm/10" 05-1440-25
 28 cm/11" 05-1440-28
 30 cm/12" 05-1440-30

Metzenbaum
 05-1441-18
 05-1441-20
 05-1441-23
 05-1441-25
 05-1441-28
 05-1441-30

Metzenbaum
 05-1442-18
 05-1442-20
 05-1442-23
 05-1442-25
 05-1442-28
 05-1442-30

Metzenbaum
 05-1443-18
 05-1443-20
 05-1443-23
 05-1443-25
 05-1443-28
 05-1443-30



Sims
 05-1444-20 20 cm/8"
 05-1444-23 23 cm/9"



Straight
 05-1445-20 20 cm/8" 05-1446-20
 05-1445-23 23 cm/9" 05-1446-23



Sims
 05-1447-20 20 cm/8"
 05-1447-23 23 cm/9"



Curved
 05-1448-20 20 cm/8" 05-1449-20
 05-1448-23 23 cm/9" 05-1449-23



Dubois
05-1450-27 27 cm/10½"

Curved



Dubois
05-1451-27 27 cm/10½"



Doyen
05-1452-16 16 cm/6¼"
05-1452-18 18 cm/7"

Straight



Doyen
05-1453-16 16 cm/6¼"
05-1453-18 18 cm/7"

Curved



Kelly
05-1454-16 16 cm/6¼"
05-1454-18 18 cm/7"



Kelly
05-1455-16 16 cm/6¼"
05-1455-18 18 cm/7"



Fig. 1
05-1456-12



Fig. 2
05-1457-12

Straight



Fig. 3
05-1458-12

12cm/4¾"



Fig. 1
05-1459-12



Fig. 2
05-1460-12

Curved



Fig. 3
05-1461-12

12cm/4¾"

Saw Edge



Wagner
12cm/4¾"

Curved



Fig. 1
05-1462-12



Fig. 2
05-1463-12



Fig. 3
05-1464-12



Fig. 4
05-1465-12



Fig. 1
05-1466-12



Fig. 2
05-1467-12



Fig. 3
05-1468-12



Fig. 4
05-1469-12

Straight



05-1470-12
11.5cm/4½"

Curved



05-1471-12
11.5cm/4½"



Straight

Brophy (Sullivan)

05-1472-14

14.5 cm/5 3/4"

05-1473-14



Curved



Straight

Reynolds

05-1474-15

15 cm/6"

05-1474-18

18 cm/7"



Curved

05-1475-15

05-1475-18

Enucleation Scissors



Jameson
05-1476-15
15cm/6"



05-1477-12



05-1478-12



Landolt
12.5cm/5"

05-1479-12



05-1480-12

Fine Scissors ●— EN
 Feine chirurgische Scheren ●— DE
 Tijeras finas para cirugía ●— ES



9.0 cm/3½"	05-1481-09	05-1482-09	05-1483-09	05-1484-09	Standard	05-1485-09
10.5 cm/4¼"	05-1481-10	05-1482-10	05-1483-10	05-1484-10		05-1485-10
11.5 cm/4½"	05-1481-11	05-1482-11	05-1483-11	05-1484-11		05-1485-11

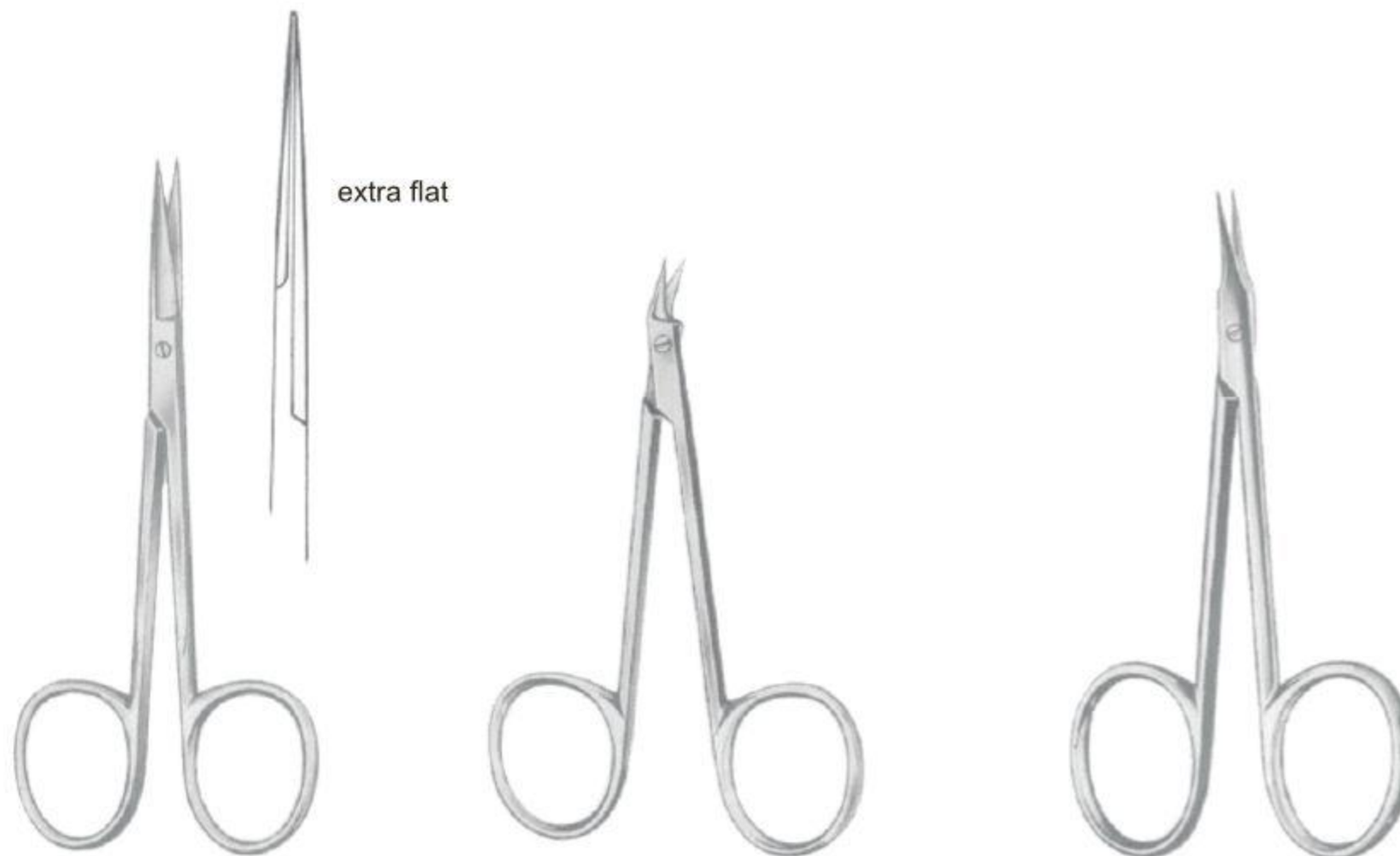

05-1486-10
 10cm/4"

05-1487-09
 9cm/3½"

Walton
 05-1488-10
 10cm/4"

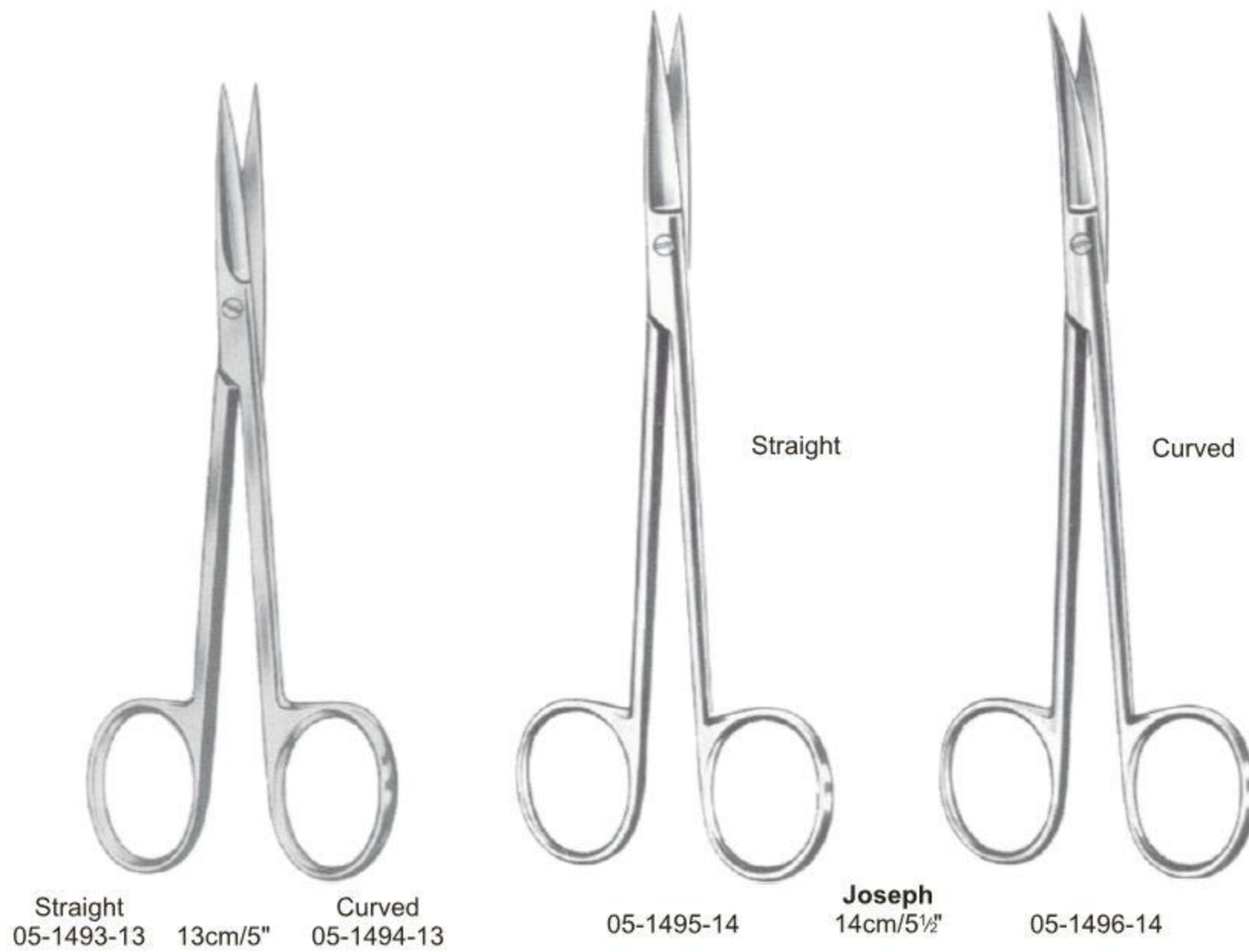
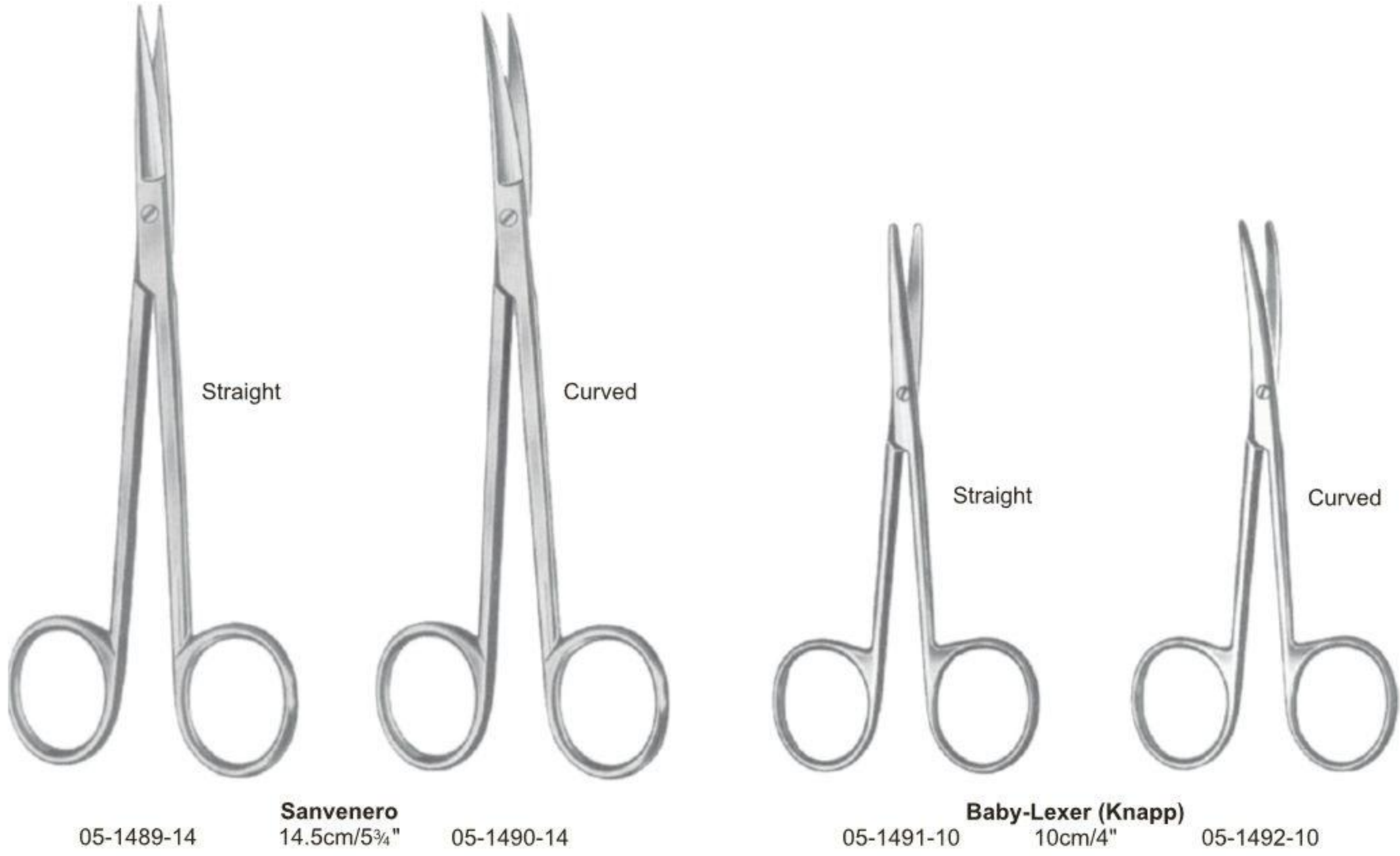



Kilner (Ragnell)
 05-1497-12 12cm/4 3/4"
 05-1497-13 13cm/5"
 05-1497-15 15cm/6"



05-1498-14
 14.5cm/5 3/4"

Coronary Scissors



05-1499-11
 11.5cm/4 1/2"



Potts-Smith
 05-1500-19
 19.5cm/7 3/4"



De Bakey
 05-1501-15
 15.5cm/6"



De Bakey
 05-1502-15
 15.5cm/6"



Favaloro
 05-1503-15
 15cm/6"

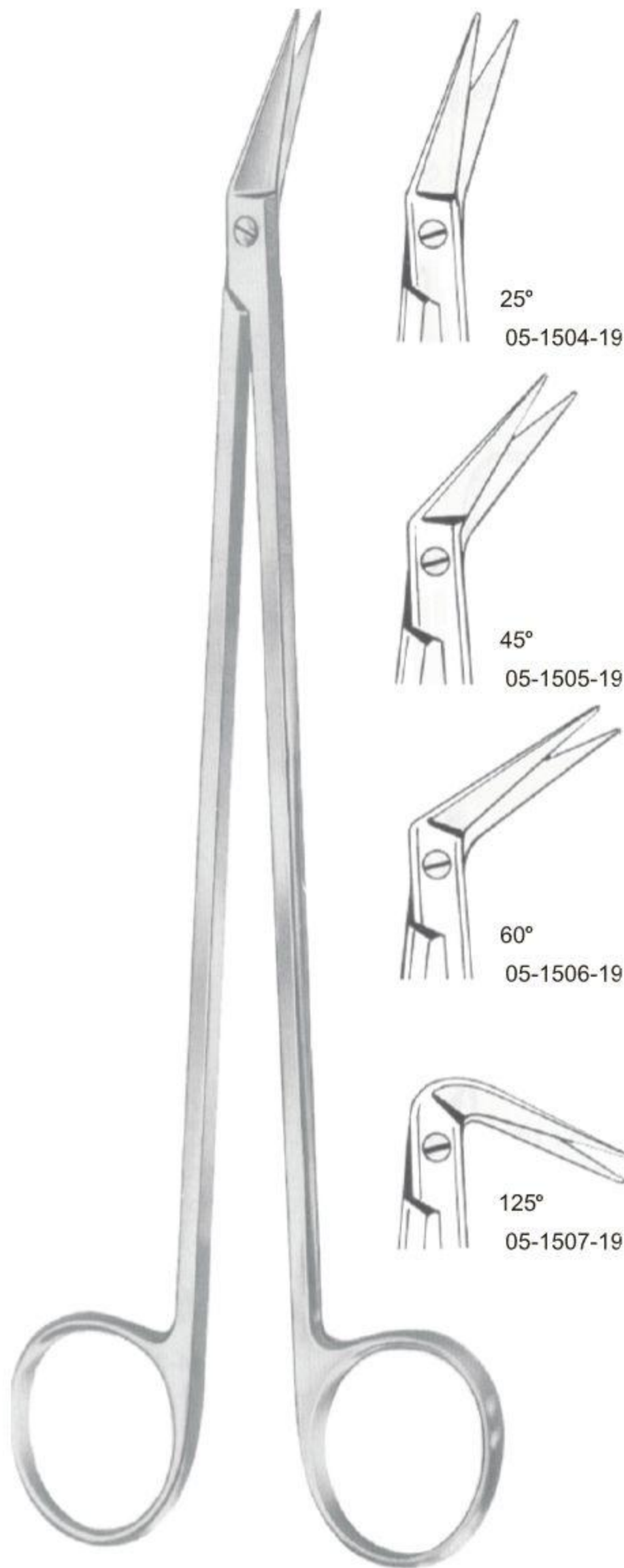

Potts-Smith
19cm/7½"

25°
05-1504-19

45°
05-1505-19

60°
05-1506-19

125°
05-1507-19



McIndoe
05-1508-19
19cm/7½"



Potts-Smith
05-1509-19
19cm/7½"



Satinsky
05-1510-24
24.5cm/10"



Klingenberg-Loth
05-1511-23
23cm/9"



De Bakey
18cm/7"

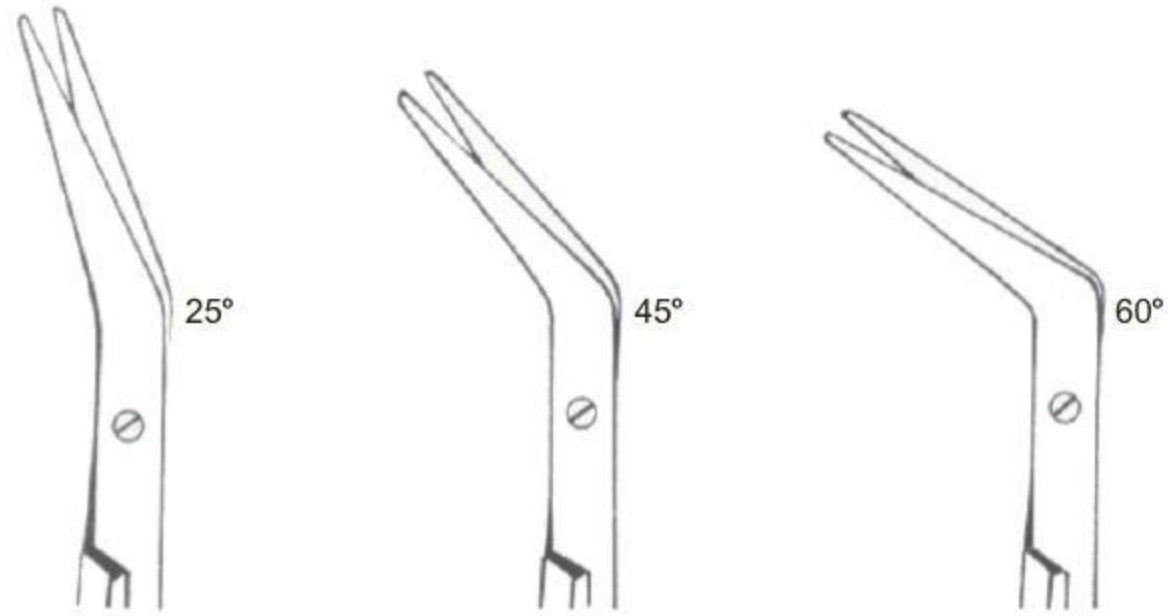

cm	In			
16.0cm	6¼"	05-1512-16	05-1513-16	05-1514-16
23.0cm	9"	05-1512-23	05-1513-23	05-1514-23
28.0cm	11"	05-1512-28	05-1513-28	05-1514-28



Baby-Hegemann
13.5cm/5¼"
Hegemann (Diethrich)
16cm/6¼"
19cm/7½"

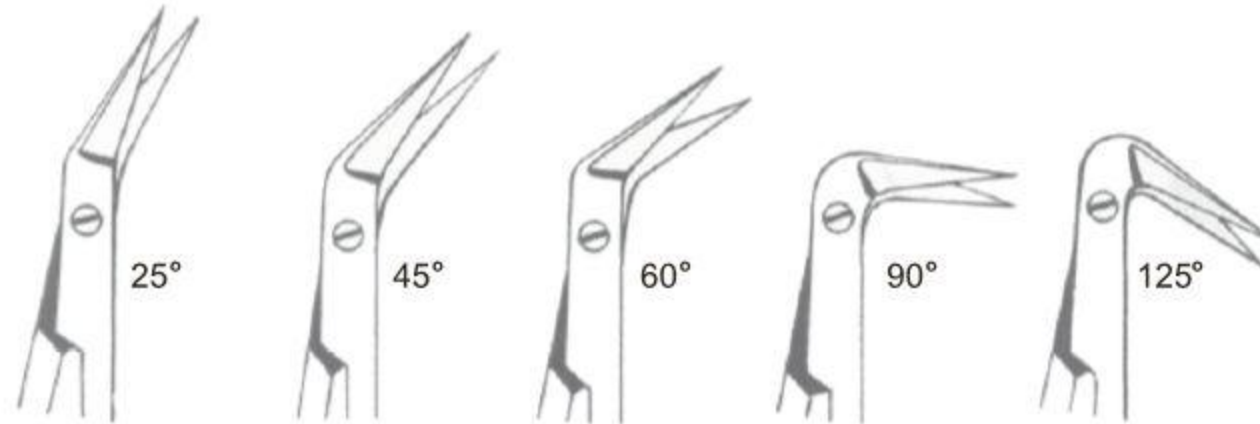

cm	In					
13.0cm	5¼"	05-1515-13	05-1516-13	05-1517-13	05-1518-13	05-1519-13
16.0cm	6¼"	05-1515-16	05-1516-16	05-1517-16	05-1518-16	05-1519-16
19.0cm	7½"	05-1515-19	05-1516-19	05-1517-19	05-1518-19	05-1519-19



Hegemann (Diethrich)
05-1520-19
19cm/7½"

Nerve Dissecting Scissors



05-1521-15
15cm/6"

Tonsil Scissors



Bottcher
05-1522-18
18cm/7"



Prince
05-1523-17
17.5cm/7"

Arteriotomy Scissors



Tonnis-Adson-Fine
05-1524-17
17.5cm/7"



Straight

Tonnis
05-1525-18
18cm/7"



Curved

Tonnis
05-1526-18
18cm/7"



Tonnis-Adson
05-1527-17
17.5cm/7"

Tonsil and Enterotomy Scissors ● EN
 Tonsillen- und Darmscheren ● DE
 Tijeras para henden uñas y nasales ● ES

Tonsil Scissors



Good
 05-1528-19
 19 cm/7½"

Lobectomy Scissors



Crafoord
 05-1529-30
 30 cm/12"



Finochietto
 05-1530-27
 27 cm/10½"

Enterotomy Scissors



05-1531-21
 21 cm/8¼"



05-1532-21
 21 cm/8¼"



05-1533-21
 21 cm/8¼"



Busch
 05-1534-13 13 cm/5"
 05-1534-16 16 cm/6 ¼"



Schumacher
 05-1535-16
 16 cm/6 ¼"



Mod. USA
 05-1536-10
 10.5 cm/4 ¼"



Braun-Stadler
 05-1537-14
 14 cm/5 ½"



Braun-Stadler
 05-1538-22
 22 cm/8 ½"



Straight
 05-1539-12

12cm/4 ¾"



Curved
 05-1540-12

Nasal Scissors ●— EN
 Nasenscheren ●— DE
 Tijeras para nasales ●— ES



Heymann
 05-1541-18
 18 cm/7"



Heymann
 05-1542-19
 19.5 cm/7³/₄"



Knight
 05-1543-18
 18 cm/7"



Fomon
 05-1544-13
 13 cm/5"



Fomon
 05-1545-13
 13.5 cm/5¹/₄"



Fomon
 05-1546-13
 13.5 cm/5¹/₄"



Cottle
 05-1547-16
 16 cm/6¹/₄"



Halle
 05-1548-19
 19 cm/7¹/₄"



Strully
05-1549-22 22 cm/8¾" 05-1550-22



Dandy
05-1551-22
17 cm/6¾"

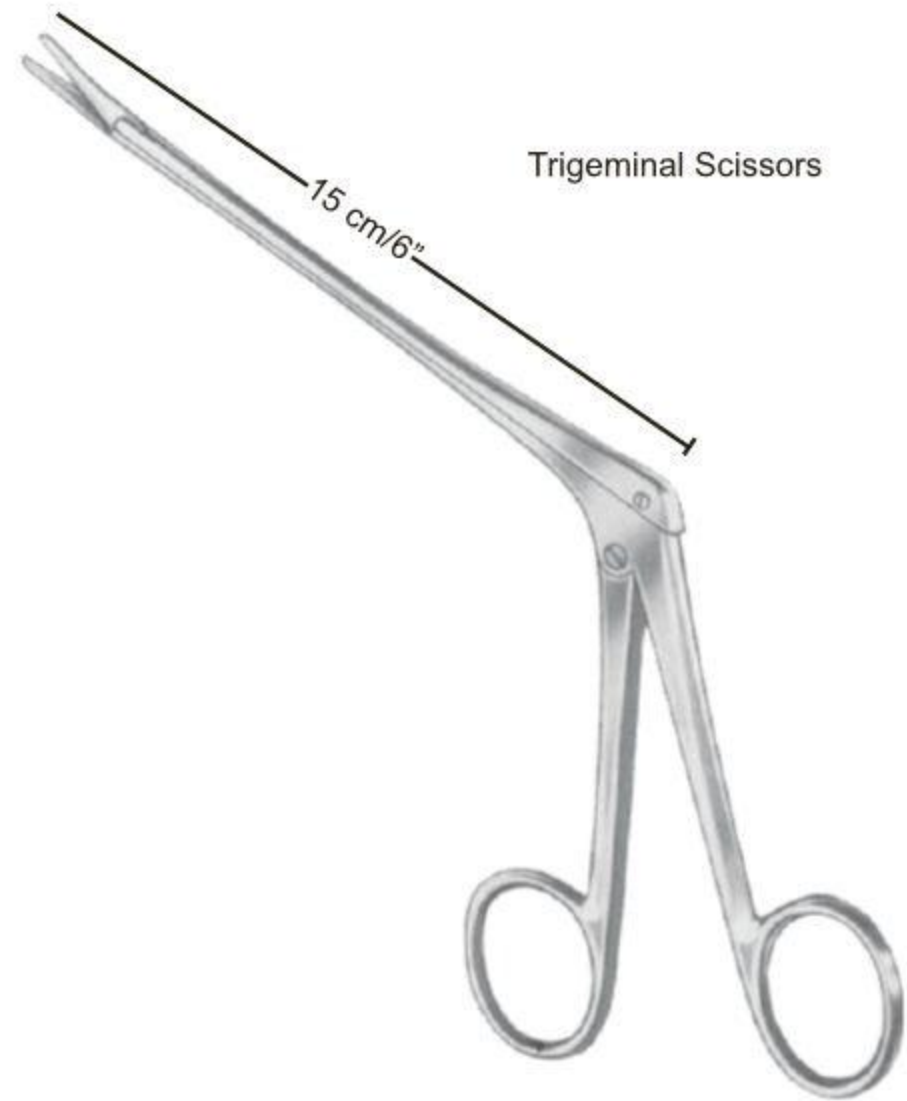

Trigeminal Scissors

Olivecrona
05-1552-15



11.5cm/4½"

Straight



05-1553-11



05-1554-11

Curved



05-1555-11



05-1556-11



Knapp
10.5cm/4¼"

Straight



05-1557-10



05-1558-10



05-1559-10

Curved



05-1560-10



05-1561-10



05-1562-10

Eye Scissors ●— EN
 Augen Scheren ●— DE
 Tijeras ojo ●— ES



Standard

9.0 cm/3½"	05-1563-09	05-1564-09	05-1565-09	05-1566-09
10.5 cm/4¼"	05-1563-10	05-1564-10	05-1565-10	05-1566-10
11.5 cm/4½"	05-1563-11	05-1564-11	05-1565-11	05-1566-11



Fine

Fine

9.0cm/3¾"			05-1569-09	05-1570-09
10.5cm/4¼"	05-1567-10	05-1568-10	05-1569-10	05-1570-10
11.5cm/4½"	05-1567-11	05-1568-11	05-1569-11	05-1570-11



Straight
Fine

9.5 cm/3¾"	05-1571-09
10.5 cm/4¼"	05-1571-10
11.5 cm/4½"	05-1571-11



Curved
Fine

05-1572-09
05-1572-10
05-1572-11



Straight

05-1573-10

Curved

10cm/4" 05-1574-10

Tenotomy Scissors



10.5cm/4¼"
11.5cm/4½"



Pointed

Straight
05-1575-10
05-1575-11



Curved
05-1576-10
05-1576-11



Blunt

Straight
05-1577-10
05-1577-11



Curved
05-1578-10
05-1578-11

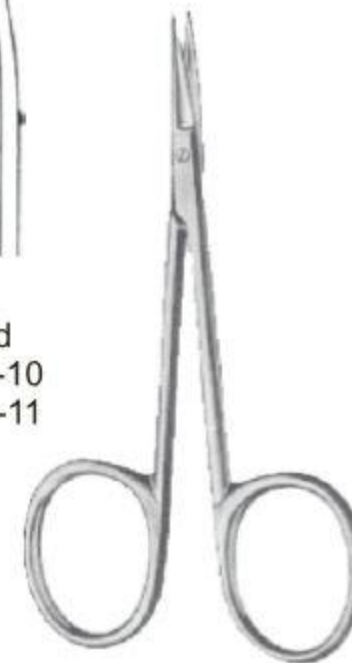

Straight
05-1579-08



Bonn
8cm/3¼" Curved
05-1580-08

Eye Scissors ●— EN
 Augen Scheren ●— DE
 Tijeras ojo ●— ES



Graefe
 05-1581-10
 10.5cm/4¼"



Wilmer
 05-1582-10
 10cm/4"



05-1583-11



11.5cm/4½" 05-1584-11



La Grange
 05-1585-11
 11.5cm/4½"



Chadwick
 05-1586-11
 11cm/4½"

Neurosurgical Scissors

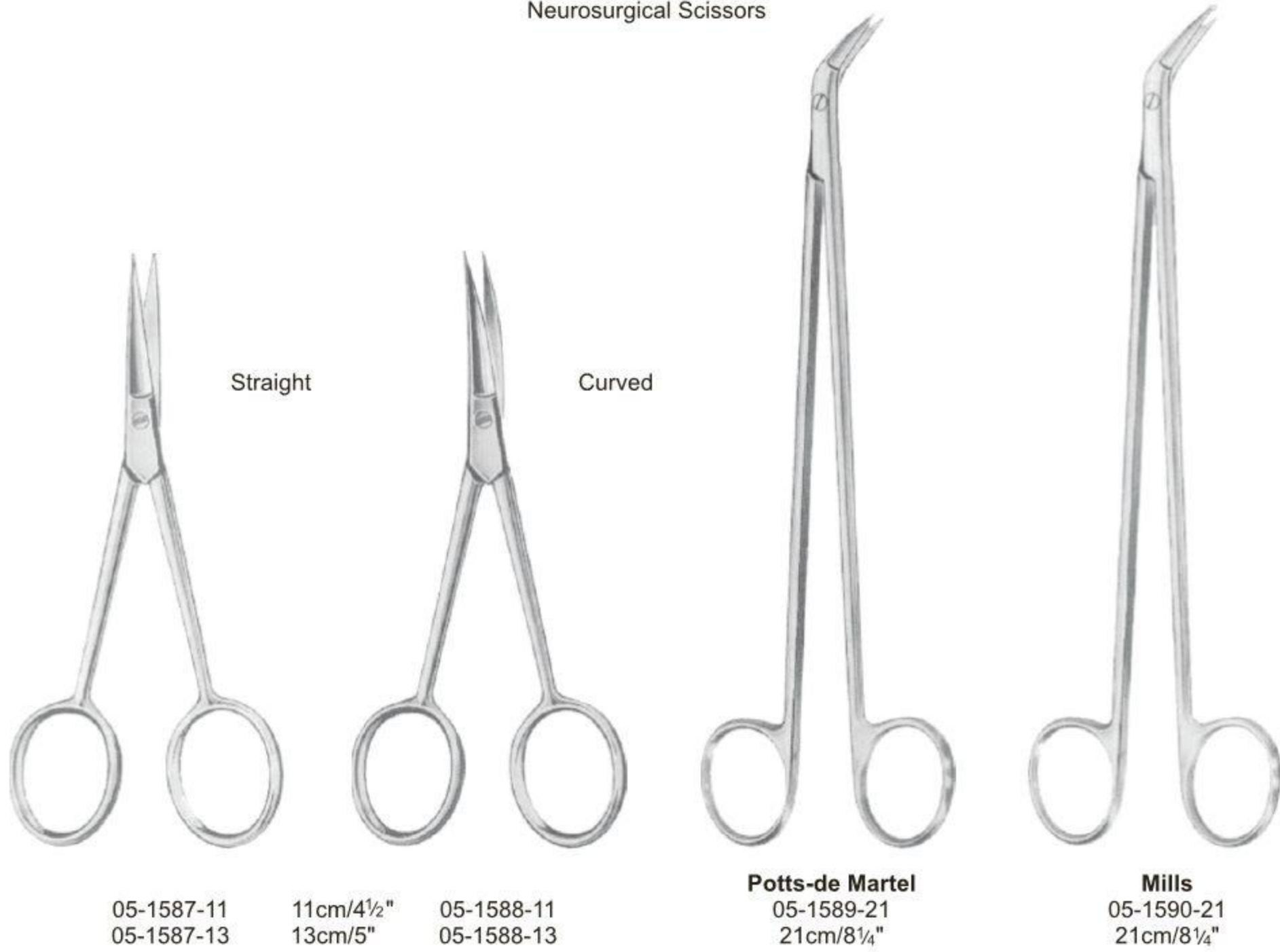

Ligature Scissors ● EN
 Ligaturscheren Fadenscheren ● DE
 Tijeras para Ligaduras ● ES



Littauer
 05-1595-14
 14cm/5½"



Spencer
 05-1596-09
 9cm/3½"



Spencer
 05-1597-10 10.5cm/4¼"
 05-1597-12 12.0cm/4¾"



Spencer-Fine
 05-1598-11 11.5cm/4½"
 05-1598-16 16cm/6¼"



Shortbent
 05-1599-09
 9cm/3½"



Northbent
 05-1600-12
 12.5cm/5"



Spencer
 05-1601-11
 11.5cm/4½"



Littler
 05-1602-11
 11.5cm/4½"



Heath
05-1603-15
15cm/6"



05-1604-10
10cm/4"



Eiselsberg
05-1605-11
11.5cm/4½"



Wire Cutting Scissors

Schoemaker-Loth
05-1606-12
12.5cm/5"



Saw Edge

Universal
05-1607-12
12cm/4¾"



	Universal	Universal	Universal
Black	05-1608-01	05-1609-01	05-1610-01
Blue	05-1608-02	05-1609-02	05-1610-02
Red	05-1608-03	05-1609-03	05-1610-03
Green	05-1608-04	05-1609-04	05-1610-04

14.5 cm/5¾"

16 cm/6¼"

18 cm/7"



Smith
05-1611-17
17.5 cm/7"



Harvey
05-1612-12
12.5 cm/5"

Saw edge

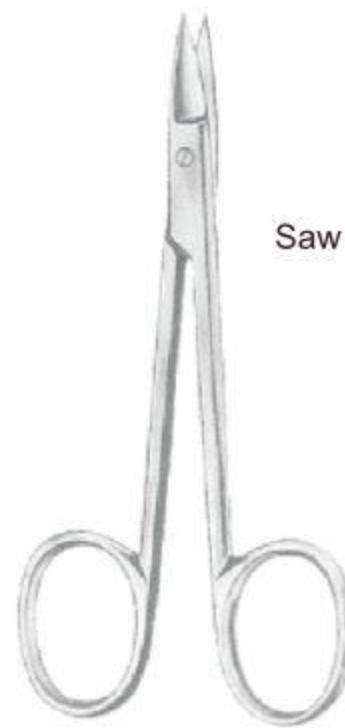

Schuknecht
05-1613-10
10 cm/4"

Saw edge



Nail Splinting Scissors

05-1614-13 13 cm/5"
05-1614-15 15 cm/6"



Lister

05-1615-09 09.0 cm/3 1/2"
05-1615-11 11.5 cm/4 1/2"
05-1615-14 14.0 cm/5 1/2"
05-1615-15 15.5 cm/6"
05-1615-18 18.0 cm/7"
05-1615-20 20.0 cm/8"



Lister

05-1616-18 18.5 cm/7 1/4"
05-1616-21 21.0 cm/8 1/4"



Lister-Excentric

05-1617-16 16 cm/6 1/4"
05-1617-19 19 cm/7 1/2"



Esmarch

05-1618-20 20 cm/8"
05-1618-22 22 cm/8 3/4"



Bergmann

05-1619-23
23 cm/9"



Lorenz

05-1620-23
23 cm/9"

Bandage Scissors ● EN

Verbandschere ● DE

Tijeras vendaje ● ES



Saw edge

05-1621-17
17 cm/6¾"



Lange
05-1622-18
18 cm/7"



Bruns
05-1623-24 24 cm/9½" Saw edge
05-1624-24 24 cm/9½" Smooth
05-1625-24 24 cm/9½" TC



Smith (Mod. USA)
05-1626-18 18 cm/7"
05-1626-20 20 cm/8"
05-1626-23 23 cm/9"



Knowles
05-1627-14
14 cm/5½"



Knowles
05-1628-14
14 cm/5½"



05-1629-13
13 cm/5"

EN —● Clothing Scissors, Plaster of Paris and Rib Shears
 DE —● Bekleidung Schere, Plaster of Paris und Rib Shears
 ES —● Tijeras ropa, yeso y tijeras Costilla



05-1630-20
20 cm/8"



Seutin
05-1631-23
23 cm/9"



05-1632-23
23 cm/9"



Collin
05-1633-22
22 cm/8¾"



Gluck
05-1634-22
22 cm/8¾"



Stille
05-1635-21
21 cm/8¼"



Stille
05-1636-24
24 cm/9½"



Stille
05-1637-23 23 cm/9"
05-1637-26 26 cm/10¼"
05-1637-37 37 cm/14½"

Crown Scissors ●— EN
 Crown shears ●— DE
 corona Tijeras ●— ES

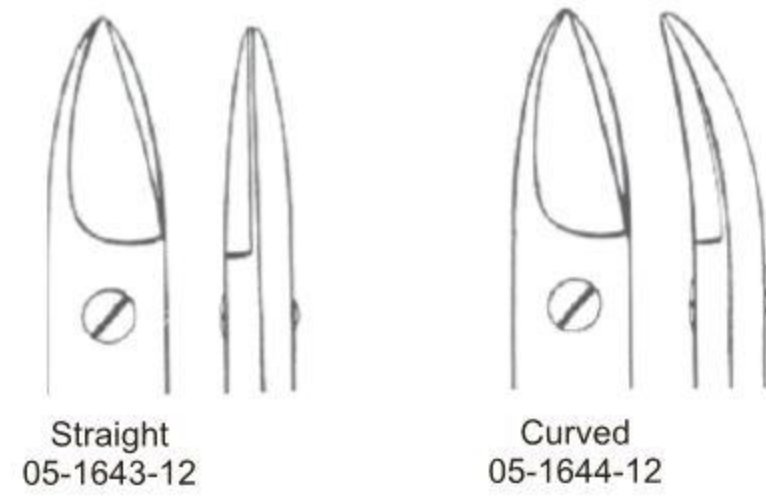
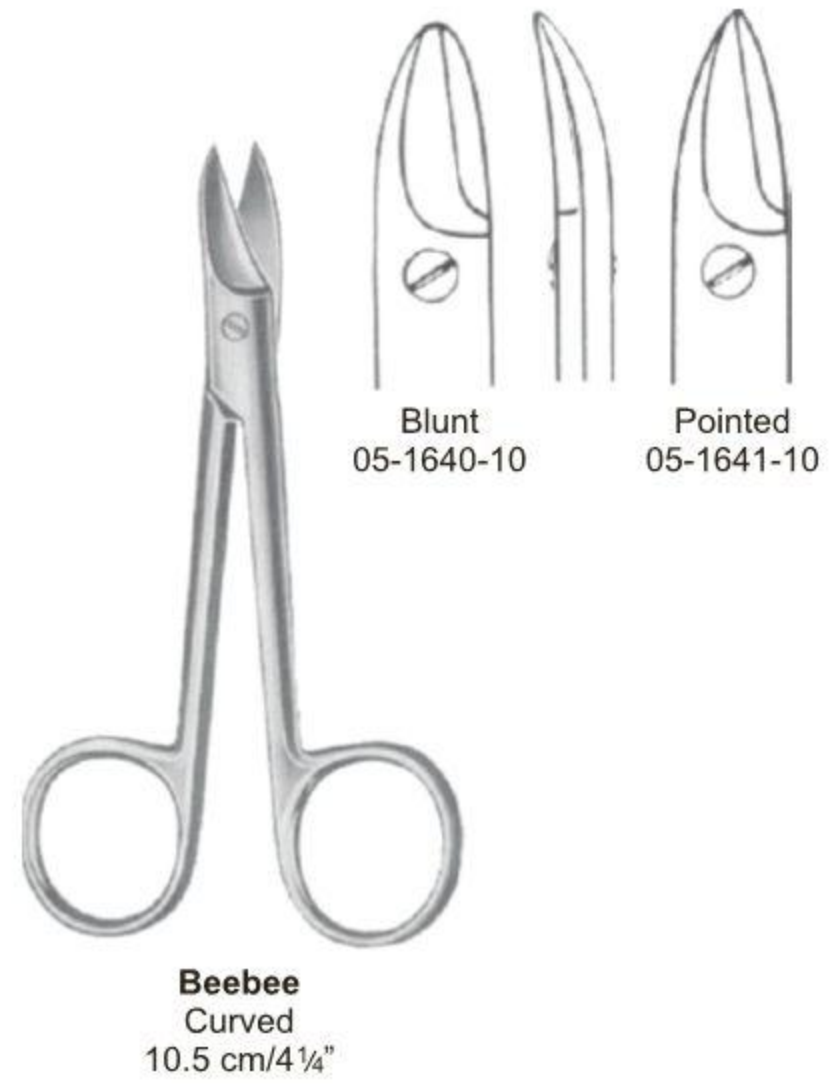
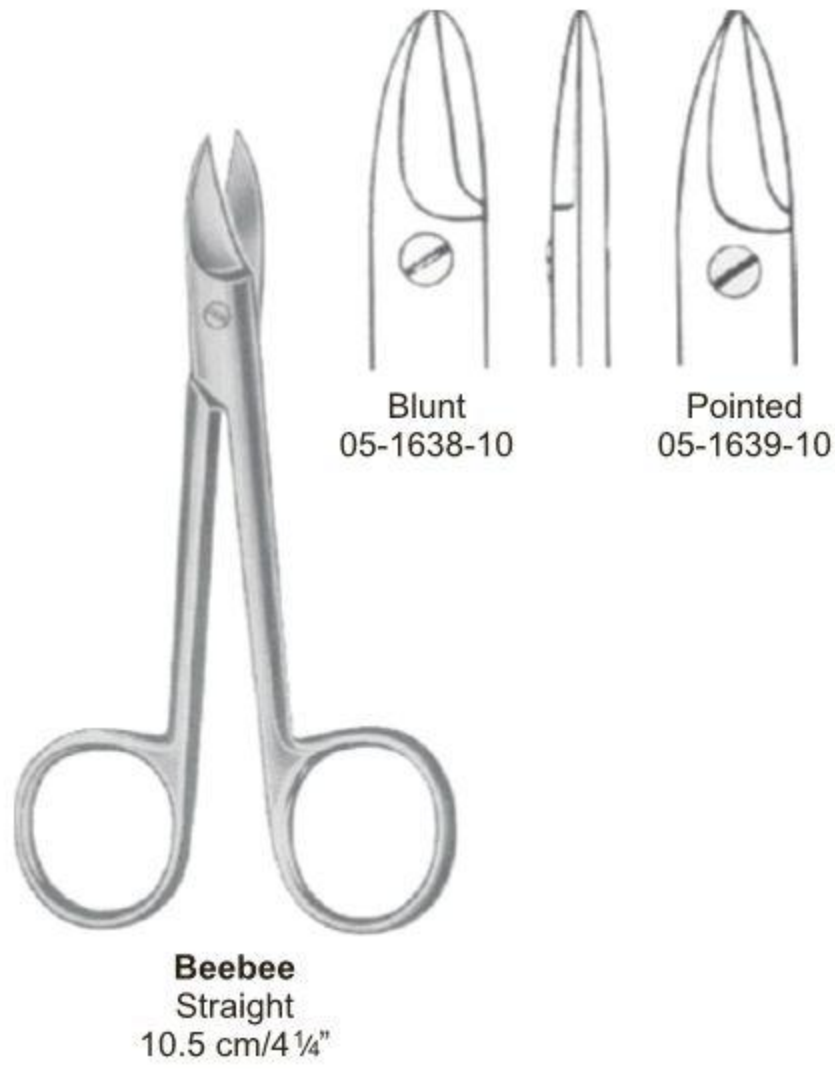



Goldmann-Fox
05-1645-13
13 cm/5"

Saw edge



Goldmann-Fox
05-1646-13
13 cm/5"



Niro
05-1647-14
14 cm/5½"



**Goldmann-Fox
(Spezial)**
05-1648-13
13 cm/5"

Saw edge



05-1649-11
11.5 cm/4½"

Fine



Quinby
05-1650-12
12 cm/4¾"



Quinby
05-1651-12
12 cm/4¾"

Gum Scissors ●— EN
 Gum Schere ●— DE
 Tijeras de las encías ●— ES



Dean
 05-1652-17
 17 cm/6¾"



Dean
 05-1653-17
 17 cm/6¾"



Locklin
 05-1654-16
 16.5 cm/6½"



Locklin
 05-1655-16
 16.5 cm/6½"



Sullivan
 05-1656-14
 14.5 cm/5¾"



Sullivan
 05-1657-14
 14.5 cm/5¾"



Neumann
 05-1658-12
 12.5 cm/5"



La Grange
 05-1659-11
 11.5 cm/4½"



05-1660-11 **Standard** 11.5 cm/4½" 05-1661-11 05-1662-11 **Standard** 11.5 cm/4½" 05-1663-11 **Chadwick** 05-1664-11 11.5 cm/4½"

Nail scissors

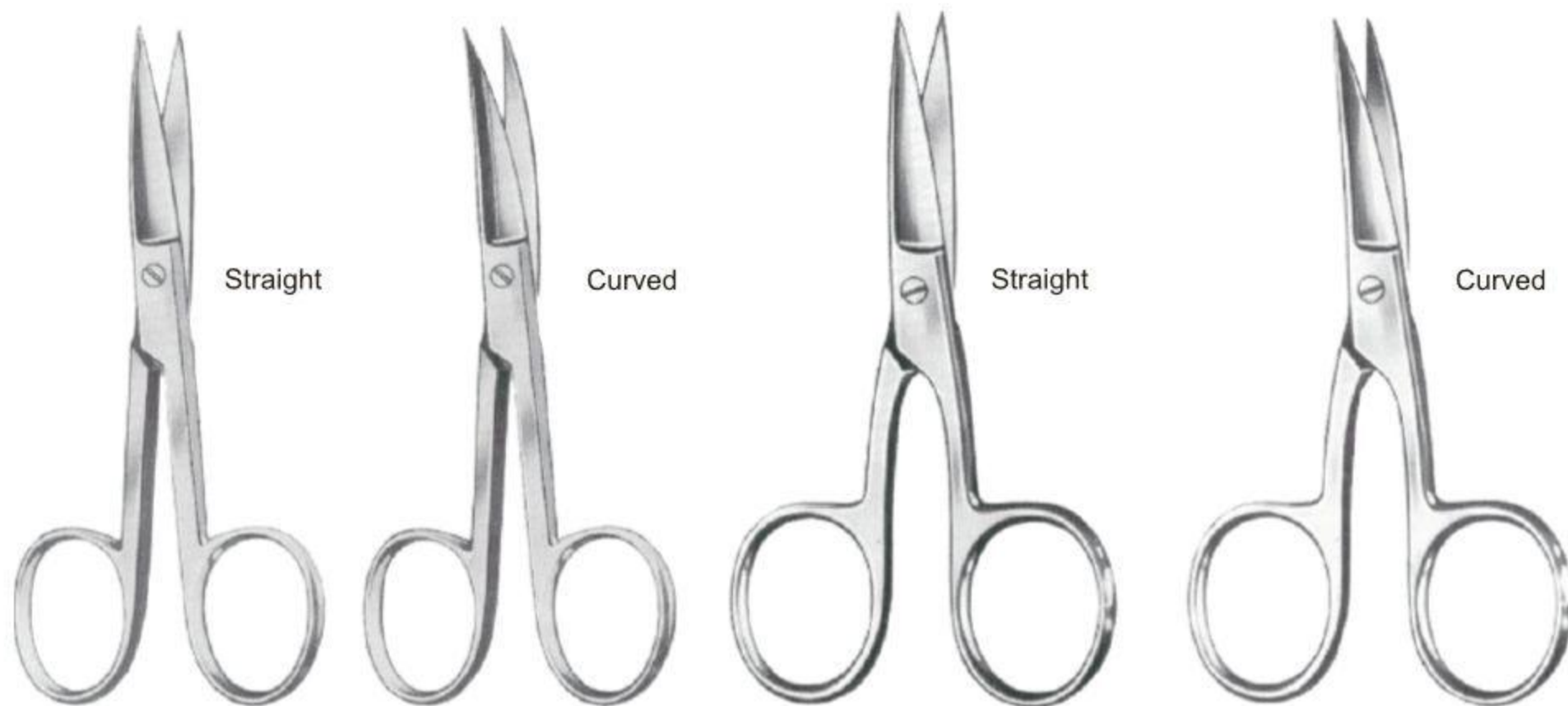

09.0 cm/3½" 05-1665-09 05-1666-09 05-1667-09 05-1668-09
10.5 cm/4¼" 05-1665-10 05-1666-10 05-1667-10 05-1668-10



Fig. 1



Fig. 2



Fig. 3

Noyes
 Fig.1 05-1669-01
 Fig.2 05-1669-02
 Fig.3 05-1669-03
 12 cm/4 3/4"



Noyes
 05-1670-12
 12 cm/4 3/4"



Wecker
 11.5 cm/4 1/2"



05-1671-01



05-1671-02

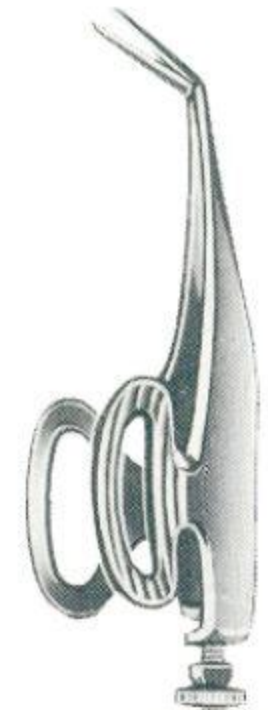

Barraquer
 05-1672-05
 5.5 cm/2 1/4"

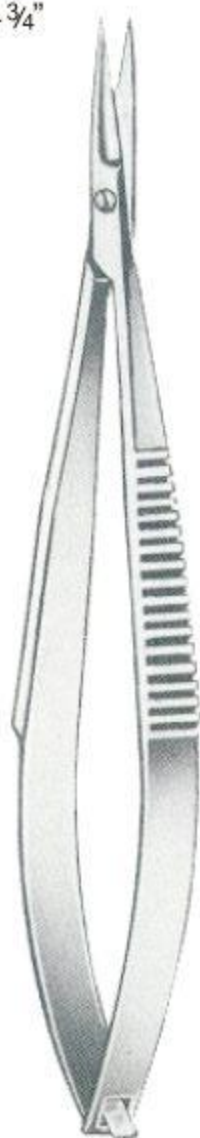

05-1673-09
 9 cm/3 "



05-1674-09



05-1675-09



05-1676-09



05-1677-09



05-1678-09

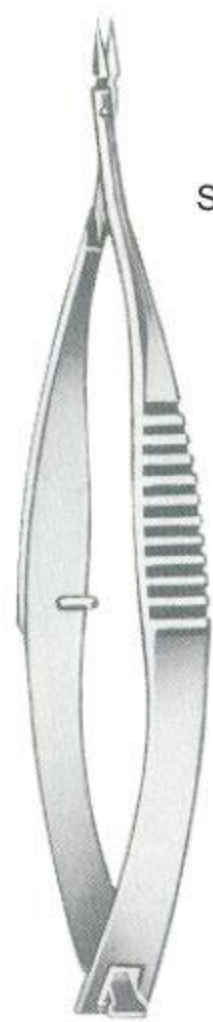

Straight

Vannas
05-1679-08
8 cm/3¼"

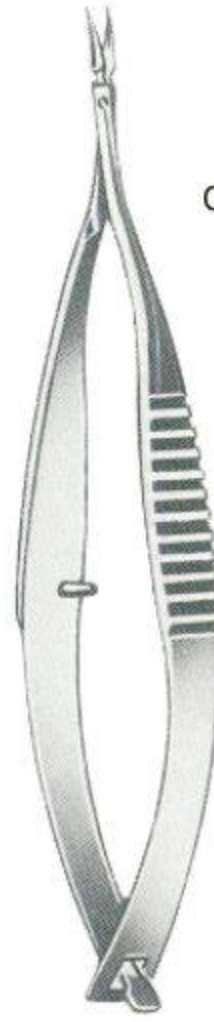

Curved

Vannas
05-1680-08
8 cm/3¼"

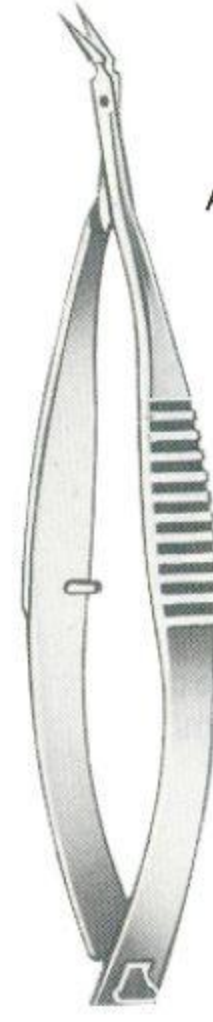

Angular

Vannas
05-1681-08
8 cm/3¼"

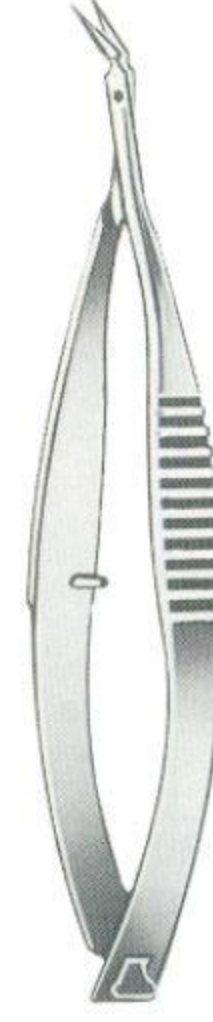

Vannas
05-1682-08
8 cm/3¼"



Straight

05-1683-08
8.5 cm/3¼"

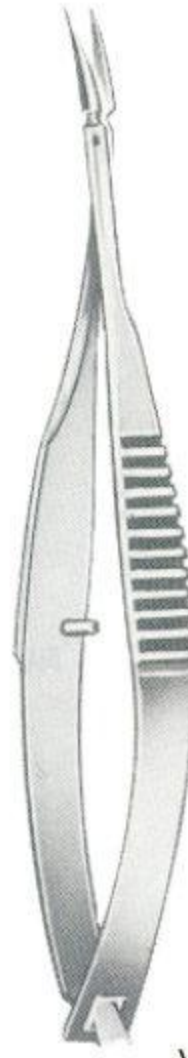

Curved

05-1684-08
8.5 cm/3½"

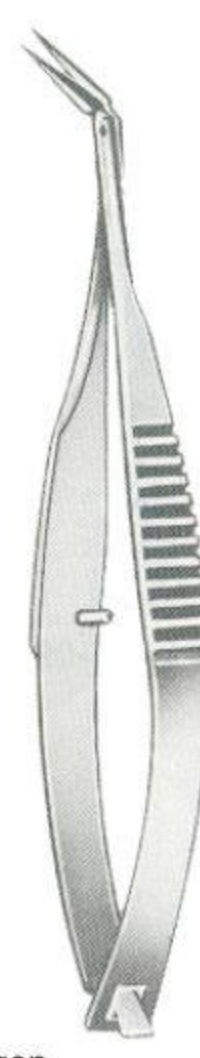

Angular

05-1685-08
8.5 cm/3½"

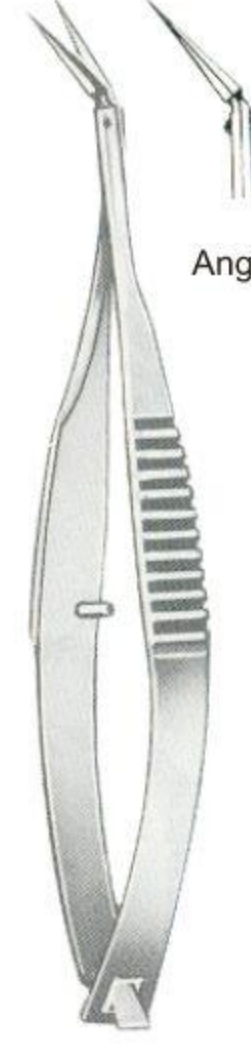

Angular

05-1686-08
8.5 cm/3½"

Vannas Mod, Tubingen

Micro Scissors ● EN
 Mikroscheren ● DE
 Micro-Tijeras ● ES



05-1687-10
 10 cm/4"

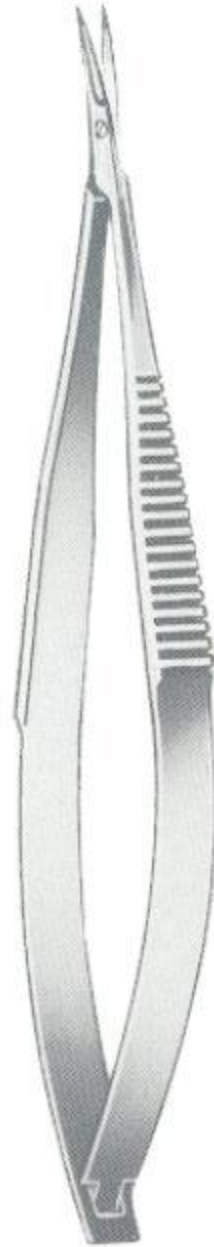

05-1688-10
 10 cm/4"



Castroviejo
 05-1689-10
 10 cm/4"



Castroviejo
 05-1690-10
 10 cm/4"



Aebli
 05-1691-10
 10 cm/4"

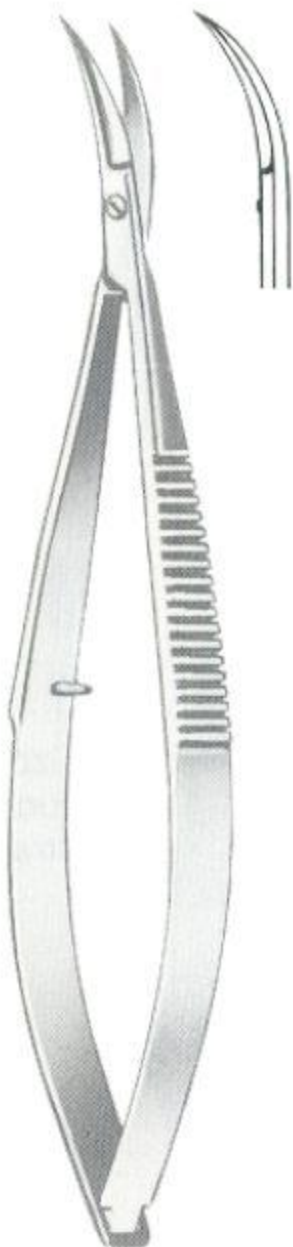

Castroviejo
 05-1692-10
 10 cm/4"



Castroviejo
 05-1693-10
 10 cm/4"

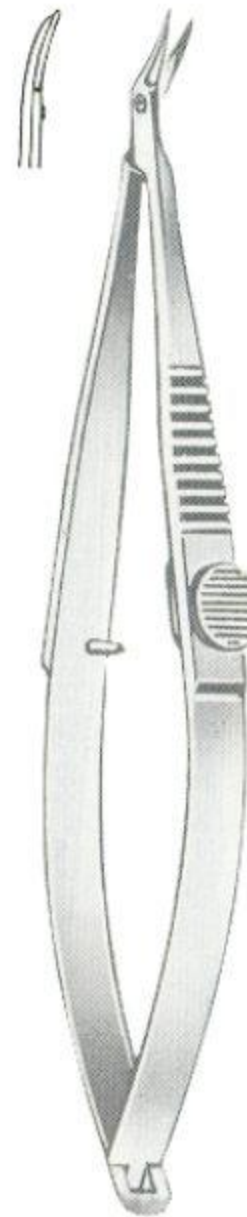

Troutman-Barraquer
 05-1694-10
 10 cm/4"

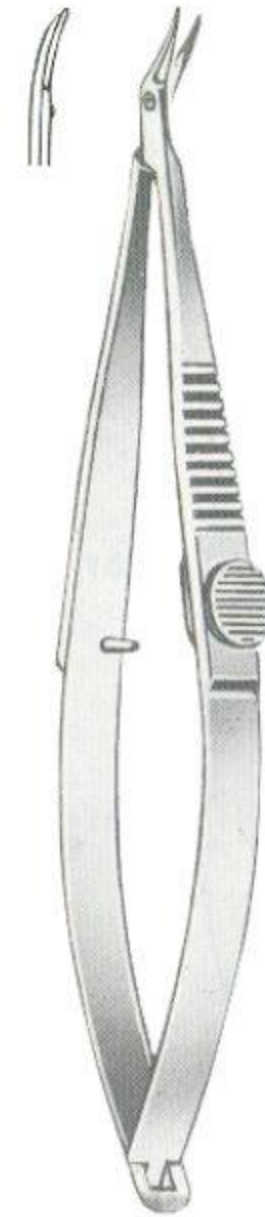

Troutman-Barraquer
 05-1695-10
 10 cm/4"

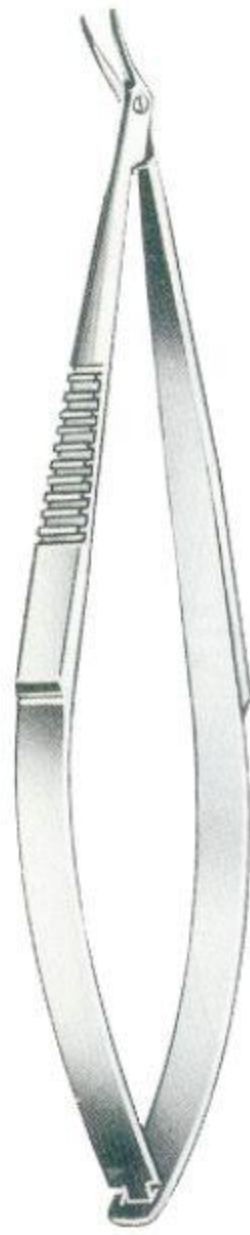

Troutman
05-1696-10
10 cm/4"

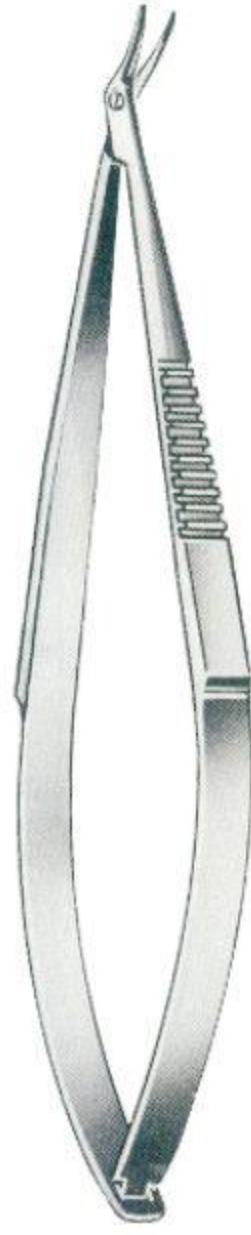

Troutman
05-1697-10
10 cm/4"

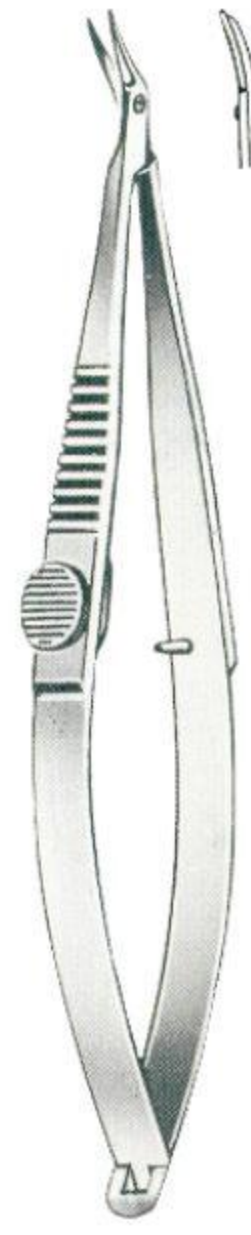

Katzin-Barraquer
05-1698-10
10 cm/4"

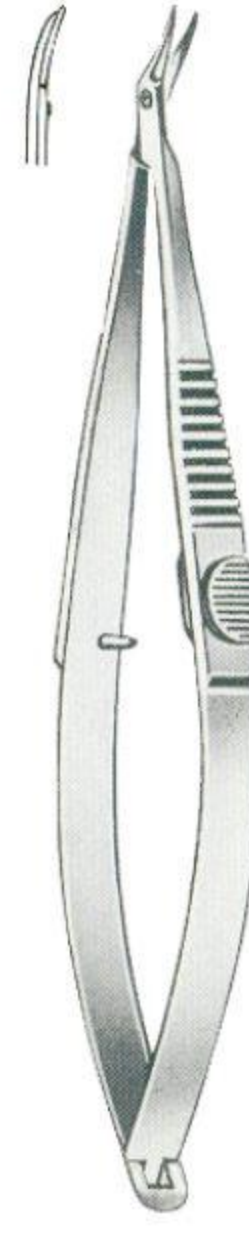

Katzin-Barraquer
05-1699-10
10 cm/4"

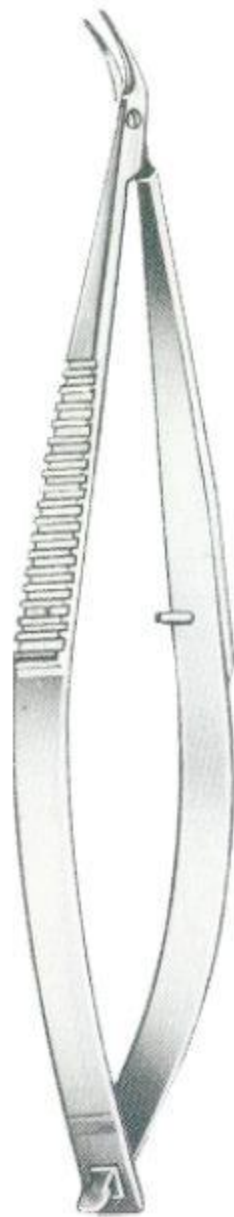

Katzin
05-1700-11
10 cm/4"

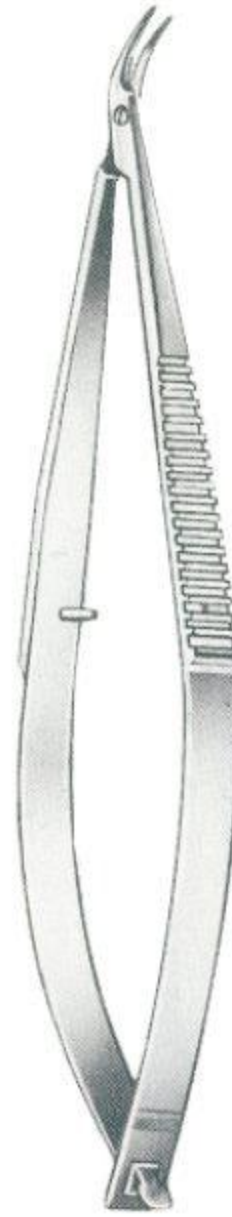

Katzin
05-1701-11
10 cm/4"



Westcott
05-1702-11
11 cm/4 "

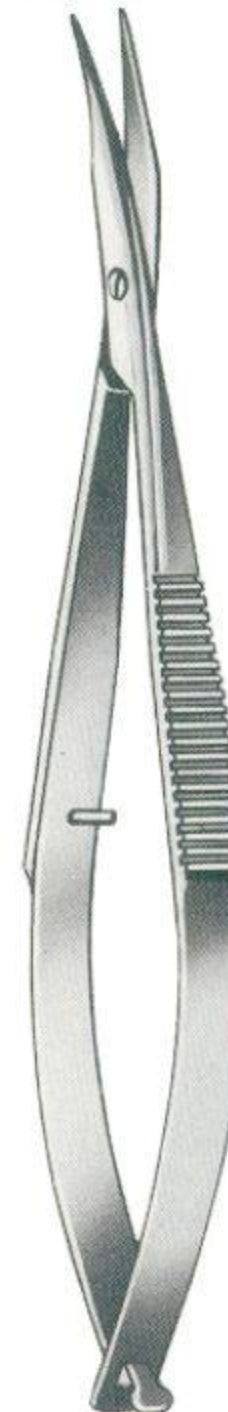

Westcott
05-1703-11
11 cm/4 "



Westcott
05-1704-11
11 cm/4 "

Micro Scissors ● EN
 Mikroscheren ● DE
 Micro-Tijeras ● ES

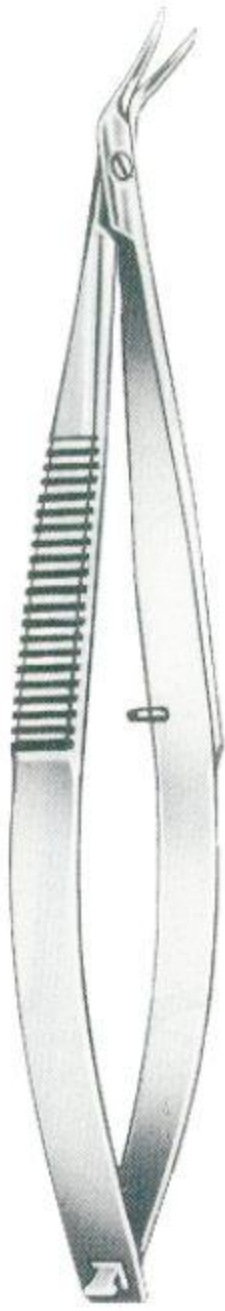

Castroviejo
 05-1705-10
 10 cm/4"

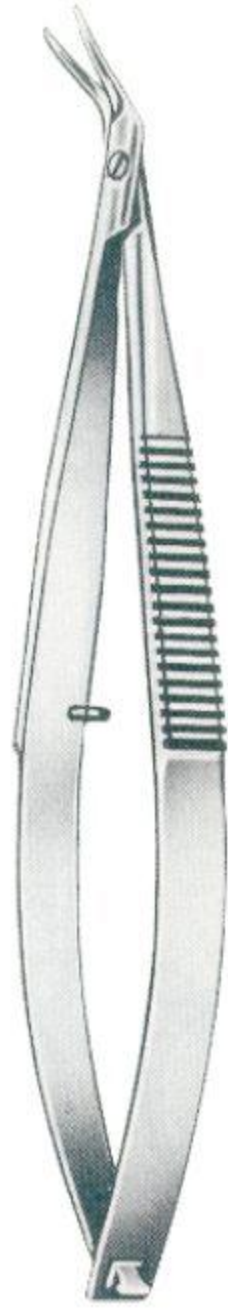

Castroviejo
 05-1706-10
 10 cm/4"



Castroviejo
 05-1707-11
 11.5 cm/4½"



Castroviejo
 05-1708-11
 11.5 cm/4½"



Troutmann-Castroviejo
 05-1709-10
 10.5 cm/4¼"



Troutmann-Castroviejo
 05-1710-10
 10.5 cm/4¼"



14.5 cm/5¾"
 18.0 cm/7"

Straight
 05-1711-14
 05-1711-18

Curved
 05-1712-14
 05-1712-18



Straight

05-1713-12	12.0 cm/4 ³ / ₄ "
05-1713-16	16.0 cm/6 ¹ / ₄ "
05-1713-18	18.5 cm/7 ¹ / ₄ "



Curved

05-1714-12	12.0 cm/4 ³ / ₄ "
05-1714-16	16.0 cm/6 ¹ / ₄ "
05-1714-18	18.5 cm/7 ¹ / ₄ "

**Vannas
Straight**

05-1715-12	12.0 cm/4 ³ / ₄ "
05-1715-16	16.0 cm/6 ¹ / ₄ "

**Vannas
Curved**

05-1716-12	12.0 cm/4 ³ / ₄ "
05-1716-16	16.0 cm/6 ¹ / ₄ "

Micro Scissors ●— EN
 Mikroscheren ●— DE
 Micro-Tijeras ●— ES



Yasargil

16.5cm/6½"
 20.0cm/8"

20.0cm/8"

20.0cm/8"



Straight
 05-1717-16
 05-1717-20



Curved
 05-1718-16
 05-1718-20



Curved Downwards
 05-1719-20

Dissecting Scissors



Straight
 05-1720-20



Curved
 05-1721-20

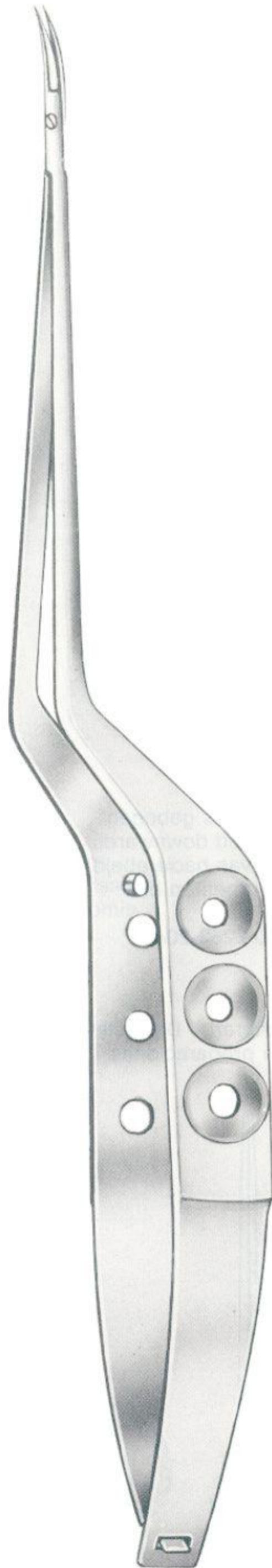

Yasargil

22.5cm/9"
24.5cm/9¾"

22.5cm/9"

22.5cm/9"



Straight
05-1722-22
05-1722-24



Curved
05-1723-22
05-1723-24



Curved Downwards
05-1724-22

Dissecting Scissors



Straight
05-1725-22



Curved
05-1726-22

Micro Scissors ●— EN
 Mikroscheren ●— DE
 Micro-Tijeras ●— ES

05-1727-18



05-1730-19

05-1728-18



05-1731-19

05-1729-18



05-1732-19



05-1733-19

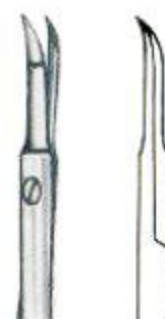

05-1734-19



Jacobson
18cm/7"



19cm/7½"

Vein Scissors

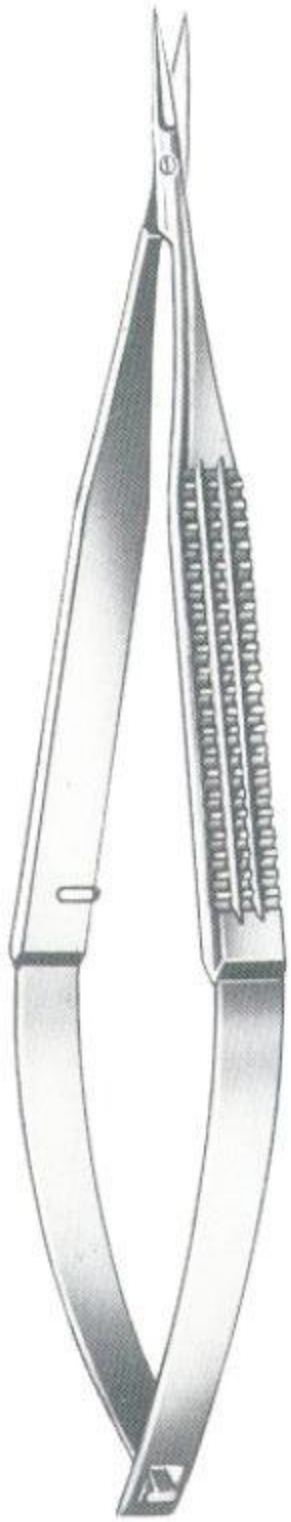

Straight
05-1735-12
12cm/4 3/4"

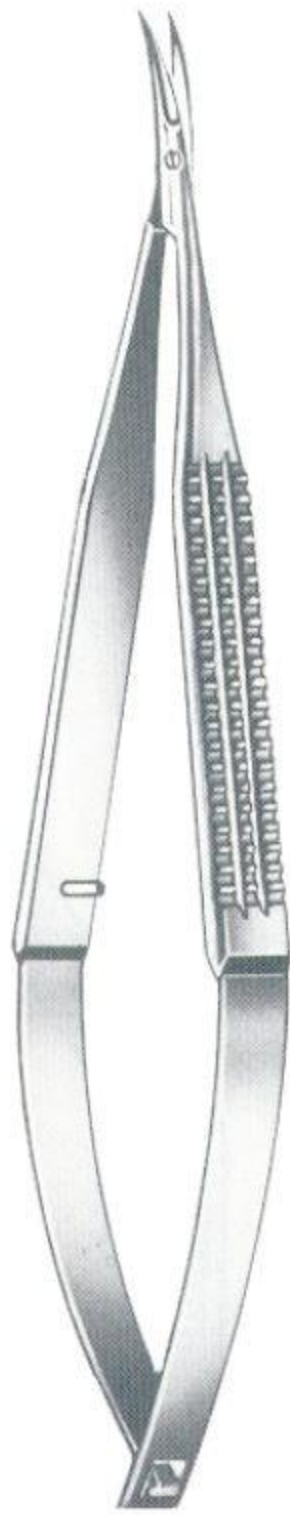

Curved
05-1736-12
12cm/4 3/4"



Straight
05-1737-12
12cm/4 3/4"

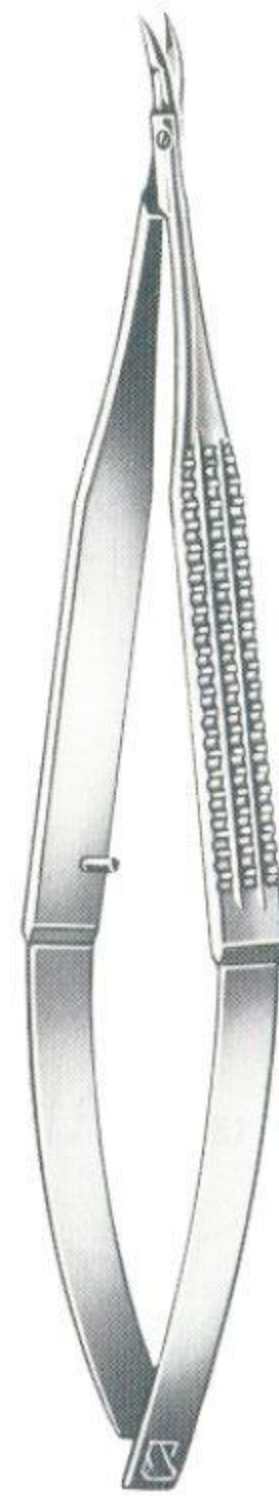

Curved
05-1738-12
12cm/4 3/4"

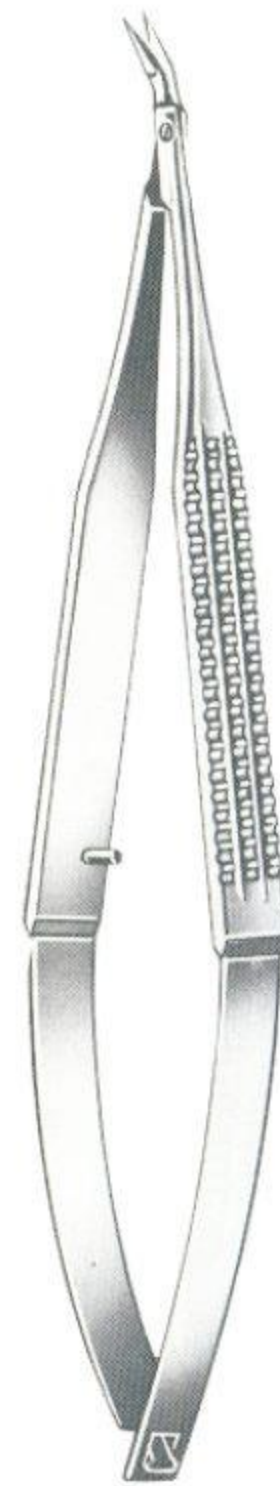

Angled up
05-1739-12
12cm/4 3/4"

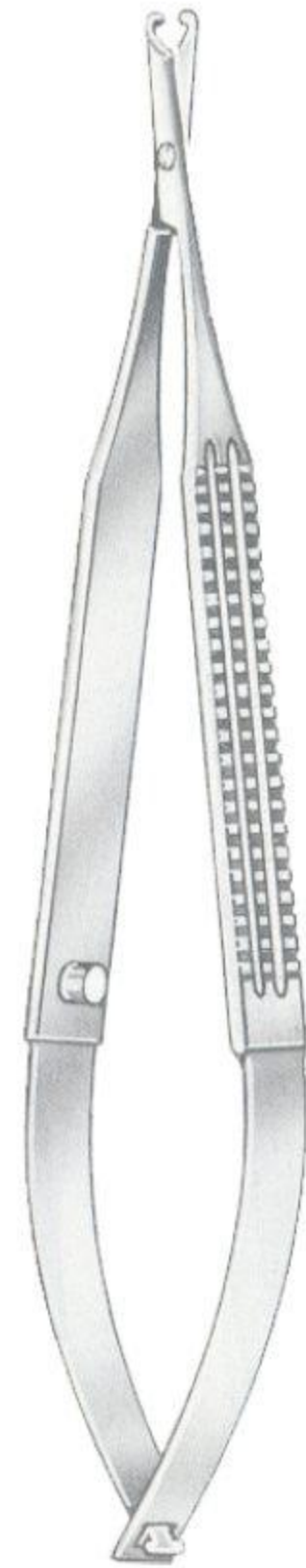

Straight
105-1740-13
13cm/5 1/8"



Saw Edge

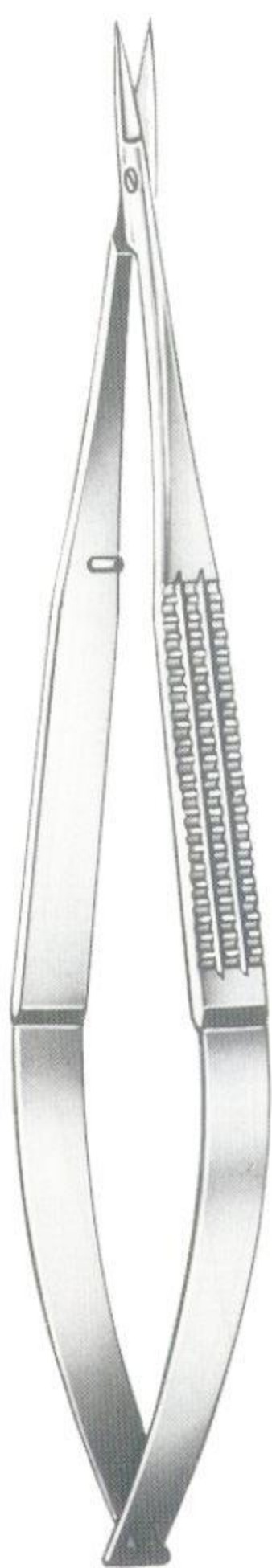

Straight
 105-1741-16
 16cm/6¼"

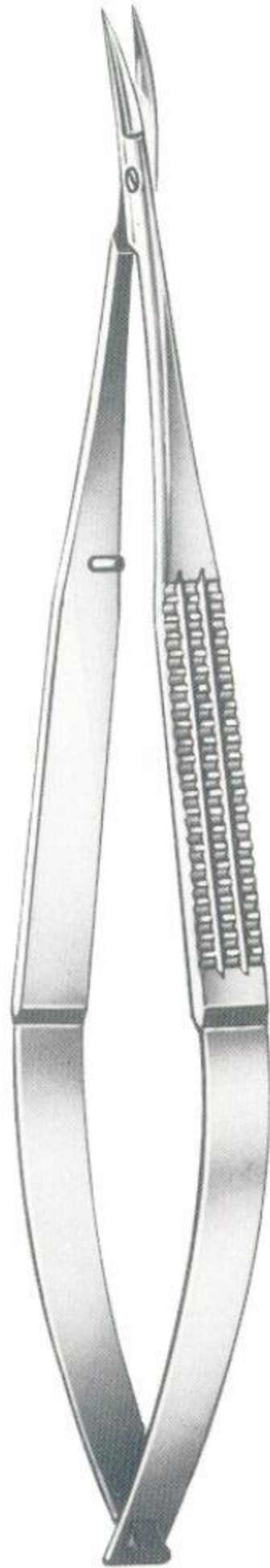

Curved
 105-1742-16
 16cm/6¼"

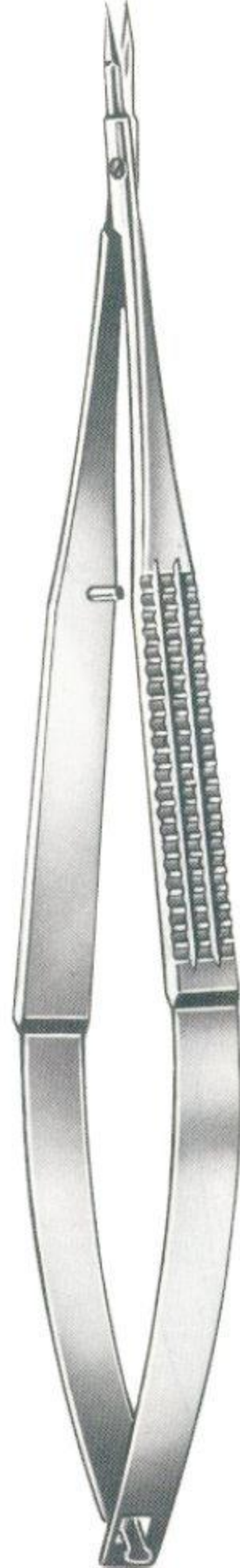

Straight
 105-1743-16
 16cm/6¼"

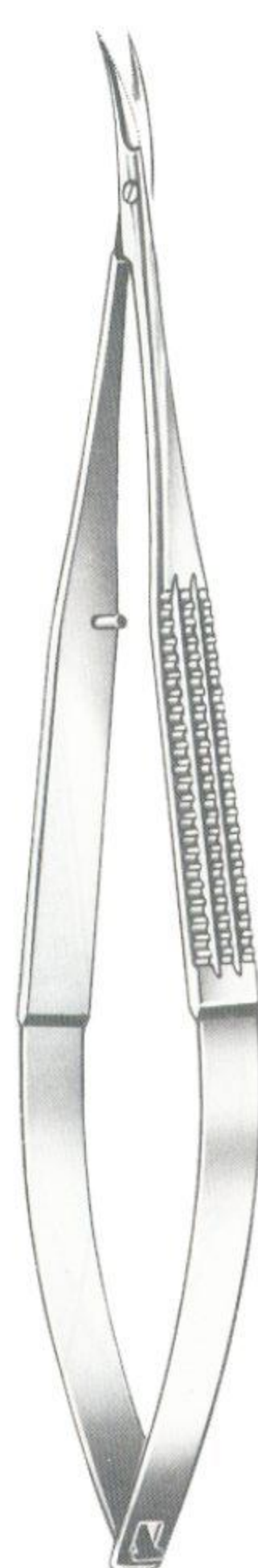

Curved
 105-1744-16
 16cm/6¼"

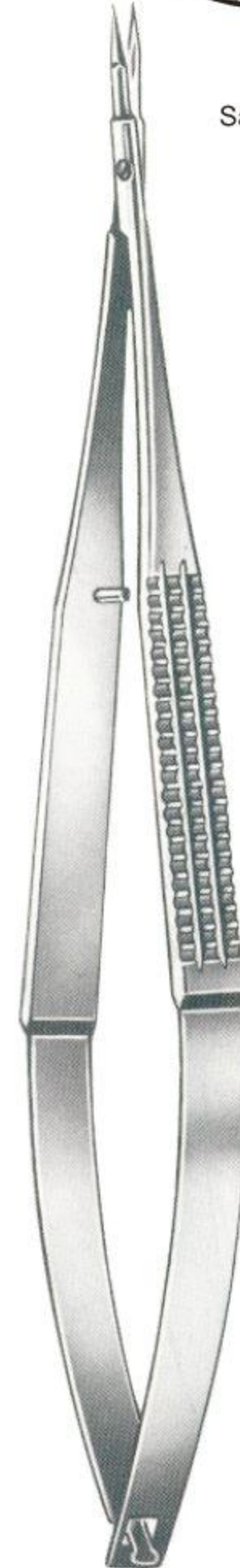

Millesi
Straight
 105-1745-16
 16cm/6¼"

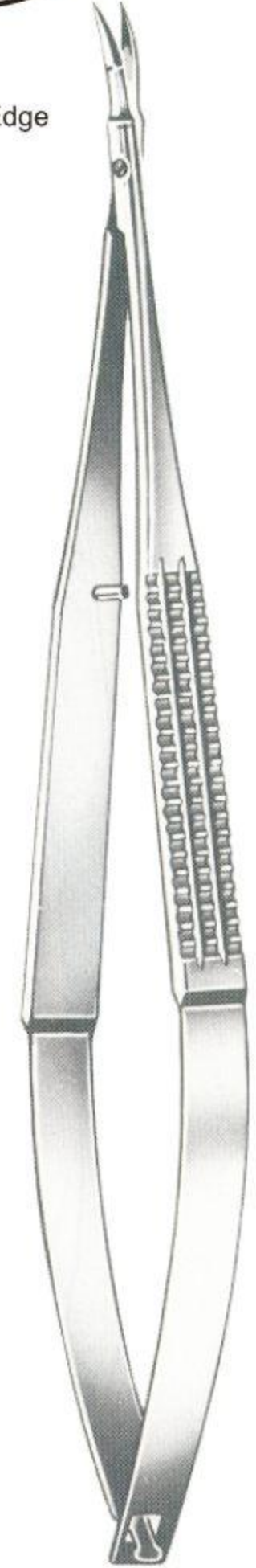

Millesi
Curved
 105-1746-16
 16cm/6¼"

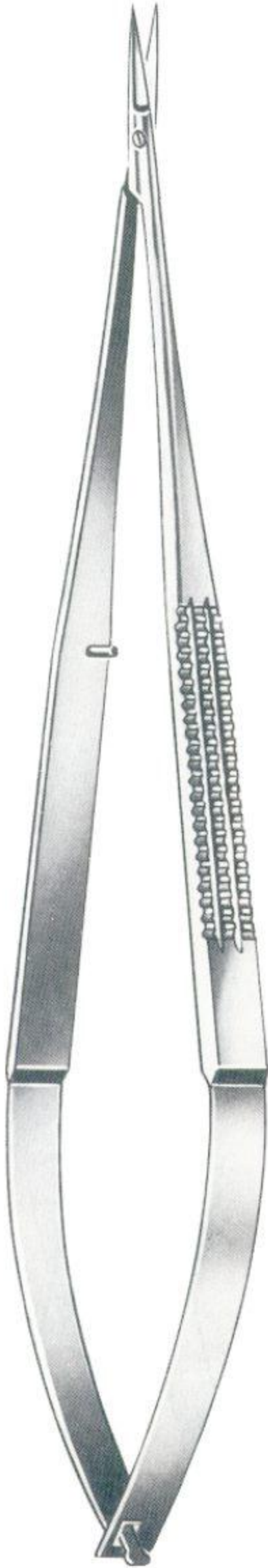

Straight
105-1747-18
18.5cm/7¼"

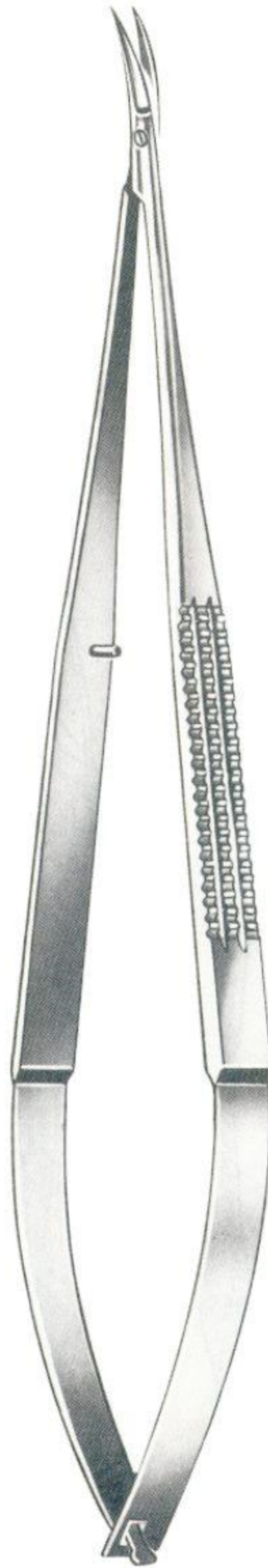

Curved
105-1748-18
18.5cm/7¼"

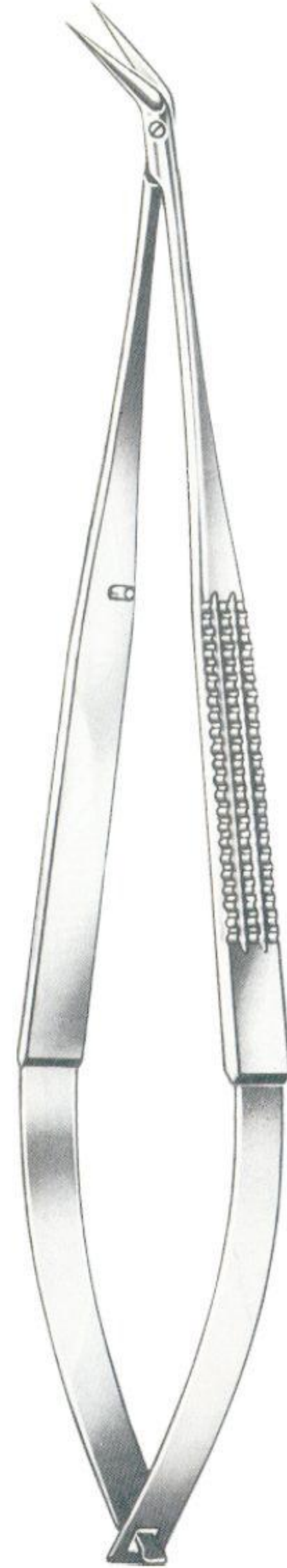

Angular
105-1749-18
18.5cm/7¼"

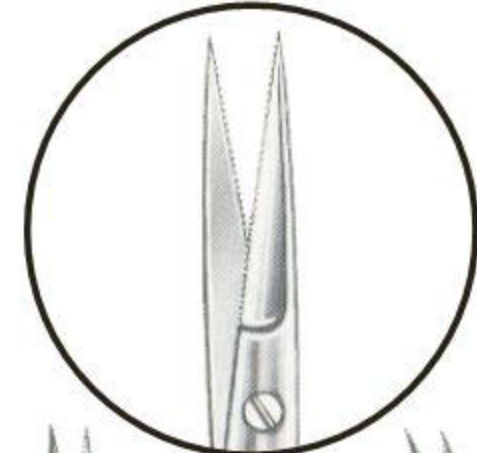

Saw Edge



Straight
 105-1750-16
 16cm/6¼"



Curved
 105-1751-16
 16cm/6¼"



Straight
 105-1752-16
 16cm/6¼"



Curved
 105-1753-16
 16cm/6¼"



Straight
 105-1754-16
 16cm/6¼"



Curved
 105-1755-16
 16cm/6¼"



Straight
105-1756-18
18.5cm/7 1/4"



Curved
105-1757-18
18.5cm/7 1/4"



Angular
105-1758-18
18.5cm/7 1/4"



Straight
105-1759-23
23cm/9"

Micro Scissors ●— EN
 Mikroscheren ●— DE
 Micro-Tijeras ●— ES



Straight
 105-1760-14
 14.5cm/5 $\frac{3}{4}$ "



Curved
 105-1761-14
 14.5cm/5 $\frac{3}{4}$ "

Dissecting Scissors



Curved
 105-1762-14
 14.5cm/5 $\frac{3}{4}$ "



Operating Scissor

Straight	Curved
05-1763-14	05-0682-14
14.5cm/5¾"	



Mayo

Straight	Curved
05-1764-14	14.5cm/5¾"
05-1764-17	17.0cm/6¾"
05-1764-23	23.0cm/9"
05-1765-14	05-1765-17
05-1765-23	05-1765-23



Mayo-Stille

Straight	Curved
05-1766-15	15.0cm/6"
05-1766-17	17.0cm/6¾"
05-1767-15	05-1767-17



Lexer

Straight	Curved
05-1768-16	05-1769-16
16cm/6¼"	



Baby-Metzenbaum

Straight	Curved
05-1770-11	05-1771-11
11.5cm/4½"	



Metzenbaum-Fine

Straight	Curved
05-1772-14	05-1773-14
14.5cm/5¾"	



Metzenbaum-Fine

Straight	Curved
05-1774-18	18cm/7"
05-1774-20	20cm/8"
05-1774-23	23cm/9"
05-1775-18	05-1775-20
05-1775-23	05-1775-23

Dissecting Scissors ●— EN
 Präparierscheren ●— DE
 Tijeras para preparacionesa ●— ES

**Sims**

Straight		Curved
05-1776-20	20 cm/8"	05-1777-20
05-1776-23	23 cm/9"	05-1777-23

**Siebold**

05-1778-24
 24 cm/9½"

**Jameson**

05-1779-15 15 cm/6"
 05-1779-18 18 cm/7"

**Reynolds**

Straight	Curved
05-1780-15	05-1781-15
	15 cm/6"



Straight	Curved
05-1782-11	05-1783-11
	11.5 cm/4½"



Straight	Curved
05-1784-11	05-1785-11
	11.5 cm/4½"

**Plastic Surgery**

Straight	Curved
05-1786-12	05-1787-12
	12 cm/4¾"

**Wagner**

Straight	Curved
05-1788-12	05-1789-12
	12 cm/4¾"



05-1790-11
11.5 cm/4½"



05-1791-14
14cm/5½"



Reynolds
05-1792-13
13cm/5"

Endarterectomy
Scissors



Potts-Smith
19cm/7½"

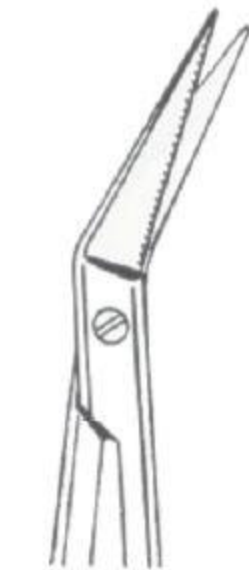

25°
05-1793-19



45°
05-1794-19



60°
05-1795-19



05-1796-17
17cm/6¾"

Bandage Scissors, Nasal Scissors ●— EN
 Verbandschere, Nasenschere ●— DE
 Tijeras para vendas, tijeras nasales ●— ES



Lister
 05-1797-14 14.5cm/5¾"
 05-1797-18 18cm/7"
 05-1797-20 20cm/8"



Braun-Stadler
 05-1798-14 14.5cm/5¾"
 05-1798-22 22cm/8¾"



Stevens
 Straight 05-1799-11 11.5cm/4½"
 Curved 05-1800-11



Heymann
 05-1801-18
 18cm/7"



Fomon
 05-1802-13
 13cm/5"



Fomon
 05-1803-13
 13cm/5"



Cottle
 05-1804-16
 16cm/6¼"



Standard
14.5cm/5¾"



Fig. 1
05-1805-14



Fig. 2
05-1806-14



Fig. 3
05-1807-14

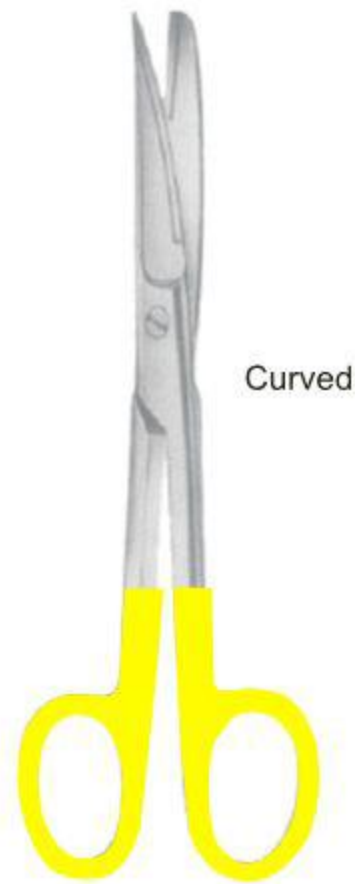

Standard
14.5cm/5¾"

Curved



Fig. 1
05-1808-14



Fig. 2
05-1809-14



Fig. 3
05-1810-14



Lexer
 Straight
 05-1811-16
 16 cm/6¼"



Lexer
 Curved
 05-1812-16
 16 cm/6¼"



Mayo
 Straight
 05-1813-14 14.5 cm/5¾"
 05-1813-18 18.0 cm/7"
 05-1813-23 23.0 cm/9"



Mayo
 Curved
 05-1814-14 14.5 cm/5¾"
 05-1814-18 18.0 cm/7"
 05-1814-23 23.0 cm/9"



Lexer-Fine
 Straight
 005-1815-16
 16 cm/6¼"



Lexer-Fine
 Curved
 05-1816-16
 16 cm/6¼"



Mayo-Stillle
 Straight
 05-1817-15 15 cm/6"
 05-1817-17 17 cm/6¾"



Mayo-Stillle
 Curved
 05-1818-15 15 cm/6"
 05-1818-17 17 cm/6¾"

Straight



Metzenbaum
05-1819-14
14.5 cm/5¾"



Metzenbaum-Fine
05-1820-14
14.5 cm/5¾"



Metzenbaum-Fine
05-1821-14
14.5 cm/5¾"

Curved



Metzenbaum
05-1822-14
14.5 cm/5¾"



Metzenbaum-Fine
05-1823-14
14.5 cm/5¾"



Metzenbaum-Fine
05-1824-14
14.5 cm/5¾"

Straight

**Metzenbaum**

18 cm/7"	05-1825-18
20 cm/8"	05-1825-20
23 cm/9"	05-1825-23
25 cm/10"	05-1825-25
28 cm/11"	05-1825-28
30 cm/12"	05-1825-30

**Metzenbaum-Fine**

05-1826-18
05-1826-20
05-1826-23
05-1826-25
05-1826-28
05-1826-30

**Metzenbaum-Fine**

05-1827-18
05-1827-20
05-1827-23
05-1827-25
05-1827-28
05-1827-30

Curved

**Metzenbaum**

18 cm/7"	05-1828-18
20 cm/8"	05-1828-20
23 cm/9"	05-1828-23
25 cm/10"	05-1828-25
28 cm/11"	05-1828-28
30 cm/12"	05-1828-30

**Metzenbaum-Fine**

05-1829-18
05-1829-20
05-1829-23
05-1829-25
05-1829-28
05-1829-30

**Metzenbaum-Fine**

05-1830-18
05-1830-20
05-1830-23
05-1830-25
05-1830-28
05-1830-30

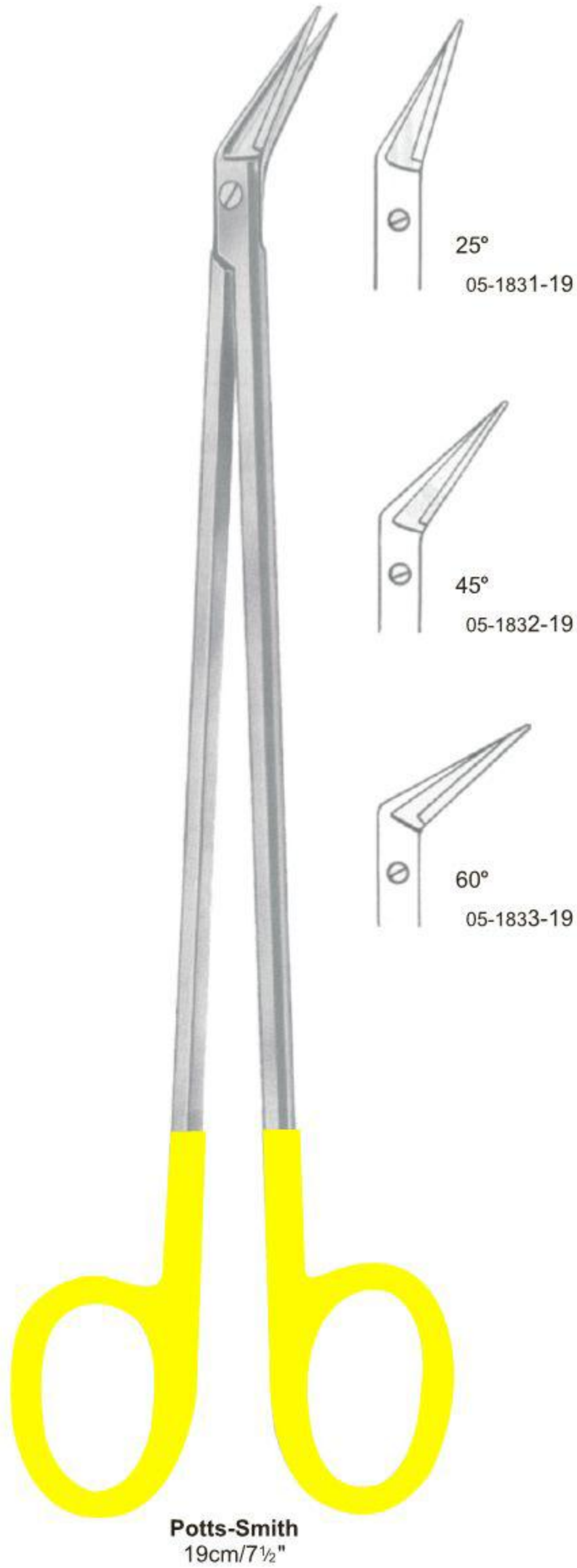

Sims
05-1836-20 20 cm/8"
05-1836-23 23 cm/7"

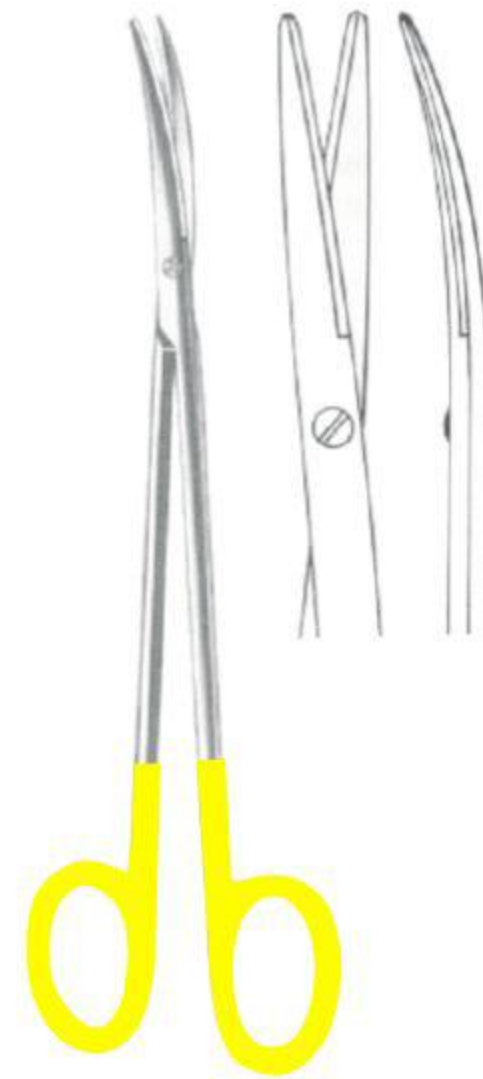
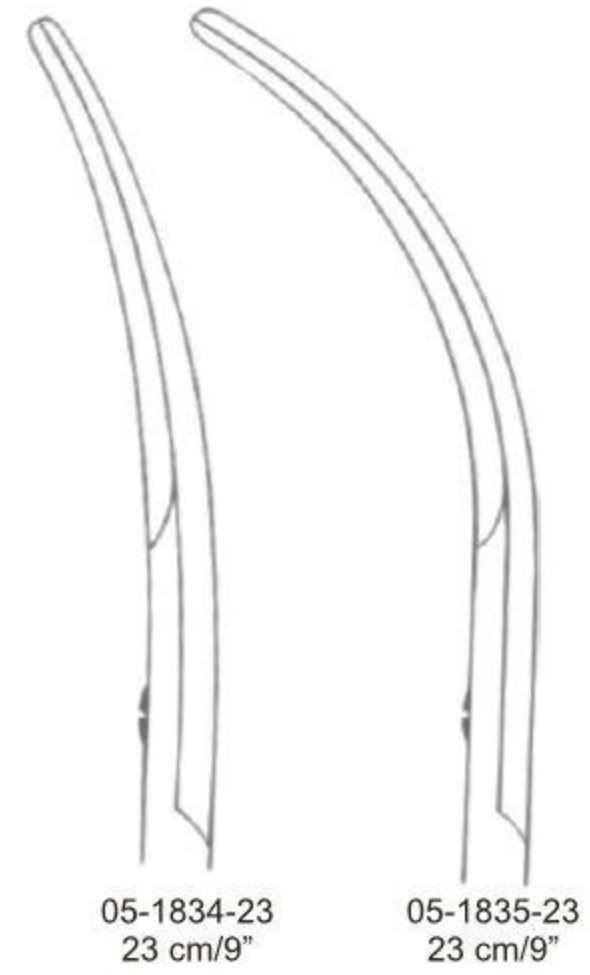

Tonnis-Adson
05-1837-17
17.5cm/7"

Gum, Fine, Eye Scissors ●— EN
 Gum, Fein, Augen Scheren ●— DE
 Goma de mascar, fina, tijeras de ojos ●— ES



Lister
 05-1838-18
 18 cm/7"



Universal
 05-1839-12
 12 cm/4¾"



Goldman-Fox
 Straight
 05-1840-13
 13 cm/5"



Goldman-Fox
 Curved
 05-1841-13
 13 cm/5"

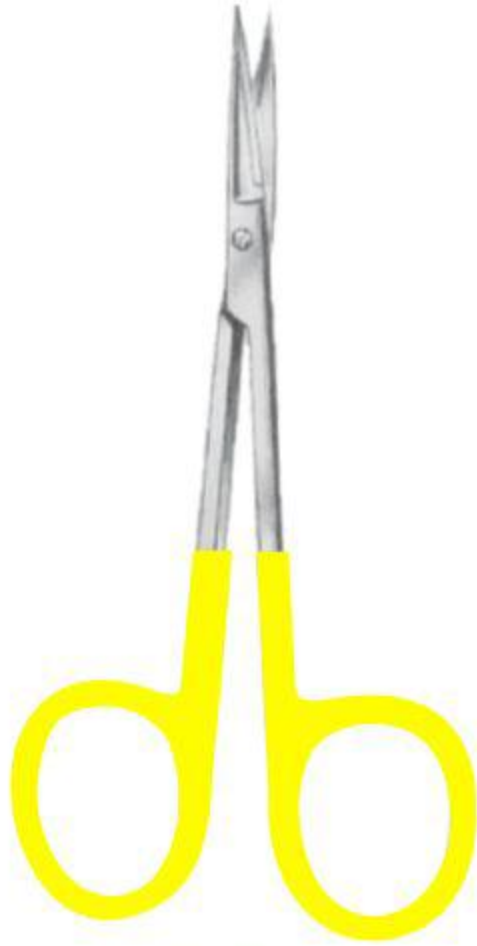

Straight
 05-1842-11



11.5cm/4½"

Curved
 05-1843-11



Straight
 05-1844-11



11.5cm/4½"

Curved
 05-1845-11

EN Forceps

DE Pinzetten

ES Pinzas

Page 95 to 111



EN Forceps

DE Pinzetten

ES Pinzas

Page 95 to 111





Standard



Standard

06-1901-10	10.5cm
06-1901-11	11.5cm
06-1901-13	13.0cm
06-1901-14	14.5cm
06-1901-16	16.0cm
06-1901-18	18.0cm
06-1901-20	20.0cm
06-1901-23	23.0cm
06-1901-25	25.0cm
06-1901-30	30.0cm



Narrow

06-1902-10	10.5cm
06-1902-11	11.5cm
06-1902-13	13.0cm
06-1902-14	14.5cm
06-1902-16	16.0cm
06-1902-18	18.0cm
06-1902-20	20.0cm
06-1902-23	23.0cm
06-1902-25	25.0cm
06-1902-30	30.0cm



USA Model



06-1903-12	12.0cm
06-1903-13	13.0cm
06-1903-14	14.5cm
06-1903-15	15.0cm
06-1903-18	18.0cm
06-1903-21	21.0cm
06-1903-25	25.0cm
06-1903-31	31.0cm



06-1904-12	12.0cm
06-1904-13	13.0cm
06-1904-14	14.5cm
06-1904-15	15.0cm
06-1904-18	18.0cm
06-1904-21	21.0cm
06-1904-25	25.0cm



Stille
06-1905-15
15.0cm

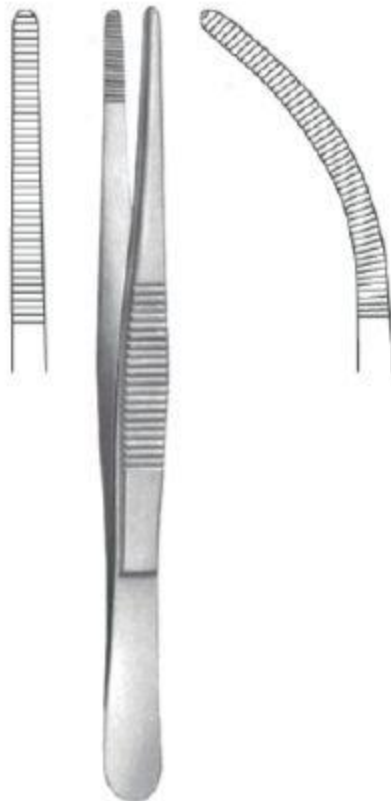

Ochsner
06-1906-14
14.0cm

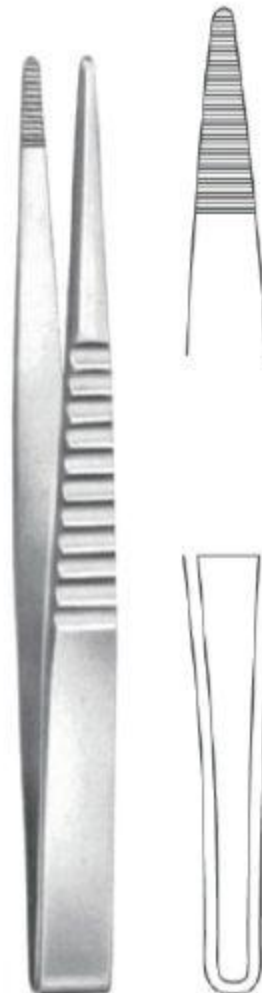

Treves
Turn over
06-1907-12 12.0cm
06-1907-15 15.0cm
06-1907-18 18.0cm
06-1907-20 20.0cm
06-1907-25 25.0cm

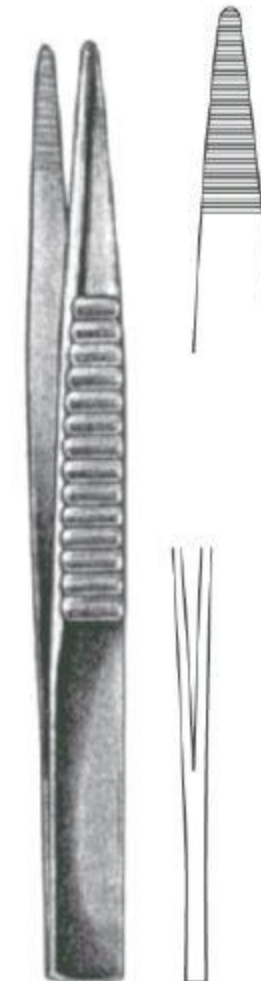

Treves
Block end
06-1908-12 12.0cm
06-1908-15 15.0cm
06-1908-18 18.0cm
06-1908-20 20.0cm
06-1908-25 25.0cm

Dressing Forceps ● EN
 Anatomische Pinzetten ● DE
 Pinzas de diseccion ● ES



Cushing
 06-1909-17 17.0cm 06-1910-17



Potts Smith
 06-1911-18 18.0cm
 06-1911-21 21.0cm
 06-1911-25 25.0cm
 06-1911-30 30.0cm



Waugh
 06-1912-15 15.0cm
 06-1912-18 18.0cm
 06-1912-20 20.0cm



Brophy
 06-1913-20 20.0cm 06-1914-20

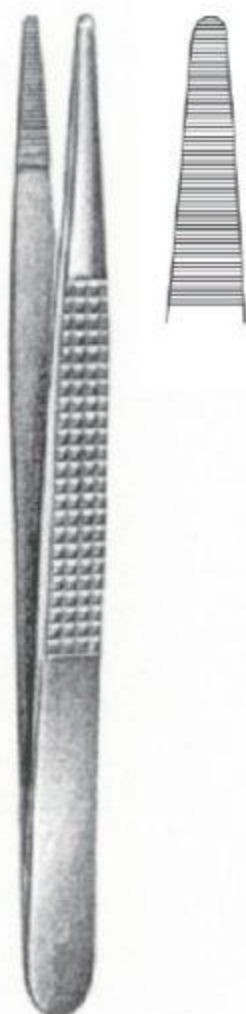

Bonney
 06-1915-17
 17.5cm



Ramsey
 06-1916-18
 18.0cm



Duehrssen
 06-1917-20
 20.0cm



Wangenstein
 06-1918-23
 23.0cm



Adson
06-1919-12 12.0cm
06-1919-15 15.0cm
06-1919-19 19.0cm



McIndoe
06-1920-15 15.0cm



Semken
06-1921-12 12.0cm 06-1922-12
06-1921-15 15.0cm 06-1922-15

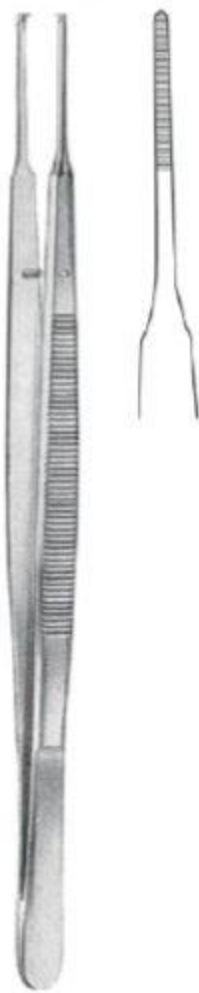

Gerald
06-1923-18 18.0cm



Gerald
06-1924-18 18.0cm



Gerald
06-1925-18 18.0cm



Taylor
06-1926-17 17.5cm Str
06-1927-17 17.5cm Cvd



Taylor
 06-1928-17
 18.5cm



Taylor
 06-1929-17
 17.5cm



Jefferson
 06-1930-18
 18.0cm, 180mm



Adson
 06-1931-18
 18.0cm, 180mm

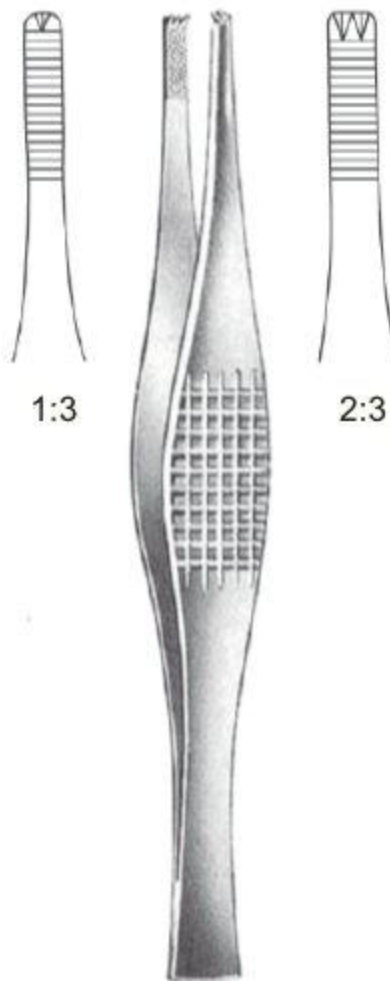

Ferris-Smith
 06-1932-18 18.0cm 06-1933-18



Ramsay
 18.0cm



Charnley
 06-1936-18 18.0cm



Jeans
 06-1937-14 14.5cm
 06-1937-17 17.5cm



Standard

	Slender 1:2	Delicate 1:2	Regular 1:2	2:3	3:4	4:5
10.0cm			06-1940-10	06-1941-10	06-1942-10	06-1943-10
11.0cm	06-1938-11		06-1940-11	06-1941-11	06-1942-11	06-1943-11
13.0cm	06-1938-13	06-1939-13	06-1940-13	06-1941-13	06-1942-13	06-1943-13
14.0cm	06-1938-14	06-1939-14	06-1940-14	06-1941-14	06-1942-14	06-1943-14
16.0cm	06-1938-16	06-1939-16	06-1940-16	06-1941-16	06-1942-16	06-1943-16
18.0cm	06-1938-18	06-1939-18	06-1940-18	06-1941-18	06-1942-18	06-1943-18
20.0cm	06-1938-20	06-1939-20	06-1940-20	06-1941-20	06-1942-20	06-1943-20
23.0cm			06-1940-23			
25.0cm			06-1940-25	06-1941-25	06-1942-25	06-1943-25
30.0cm			06-1940-30	06-1941-30	06-1942-30	06-1943-30



USA Model

12.0cm	06-1944-12			
13.0cm	06-1944-13	06-1945-13	06-1946-13	06-1947-13
14.0cm	06-1944-14	06-1945-14	06-1946-14	06-1947-14
15.0cm	06-1944-15	06-1945-15	06-1946-15	06-1947-15
18.0cm	06-1944-18			
21.0cm	06-1944-21			
25.0cm	06-1944-25			
31.0cm	06-1944-31			

Tissue Forceps ●— EN
 Chirurgische Pinzetten ●— DE
 Pinzas de diseccion con dientes ●— ES

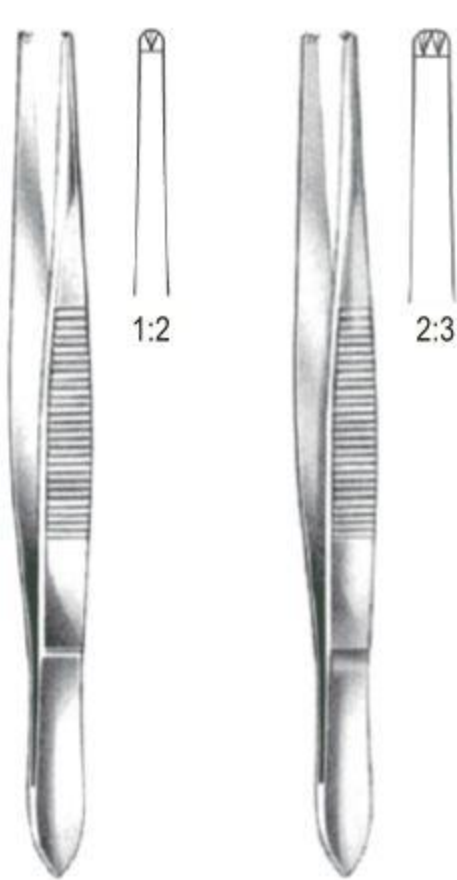

Stille
 06-1948-15 15.0cm
 06-1948-15 15.0cm



Treves
 06-1949-12 12.5cm
 06-1949-15 15.0cm
 06-1949-18 18.0cm
 06-1949-20 20.0cm
 06-1949-25 25.0cm

Adlerkreutz

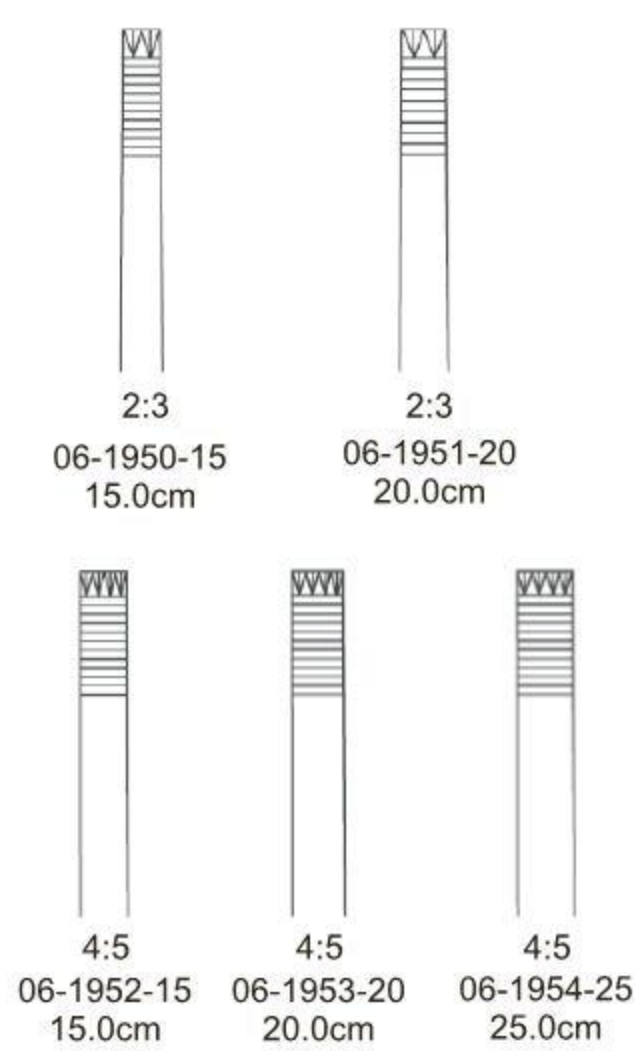

06-1950-15 15.0cm
 06-1951-20 20.0cm
 06-1952-15 15.0cm
 06-1953-20 20.0cm
 06-1954-25 25.0cm

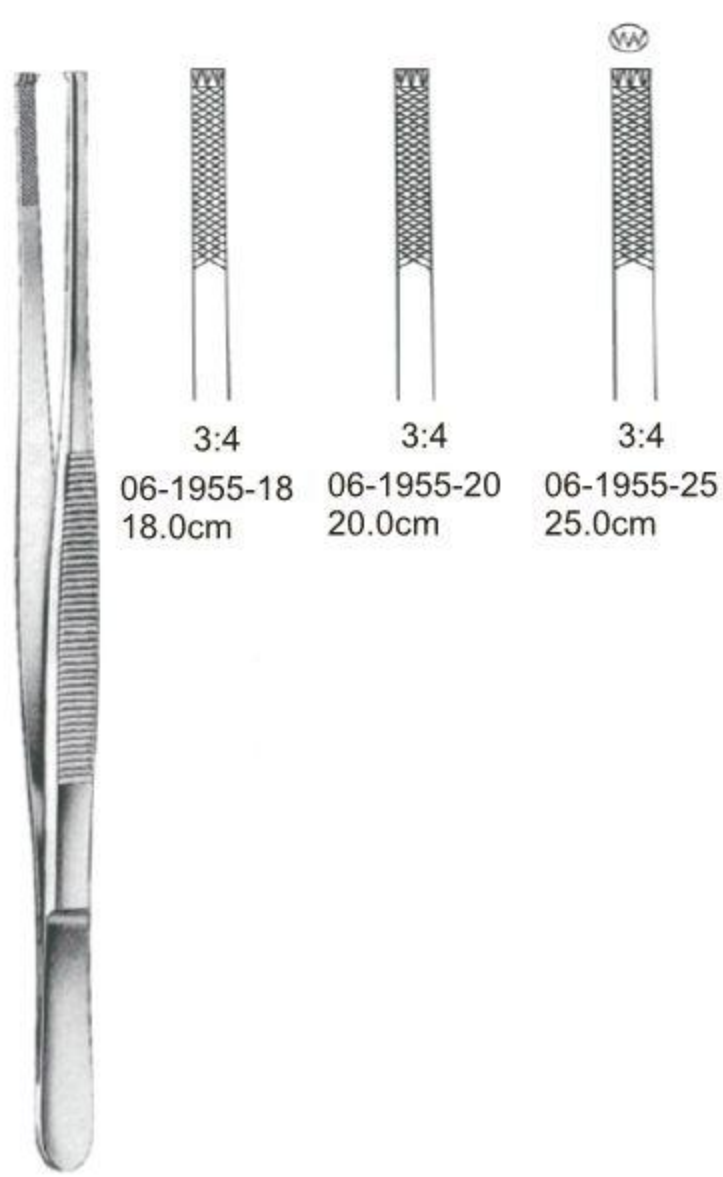

Stille-Barraya

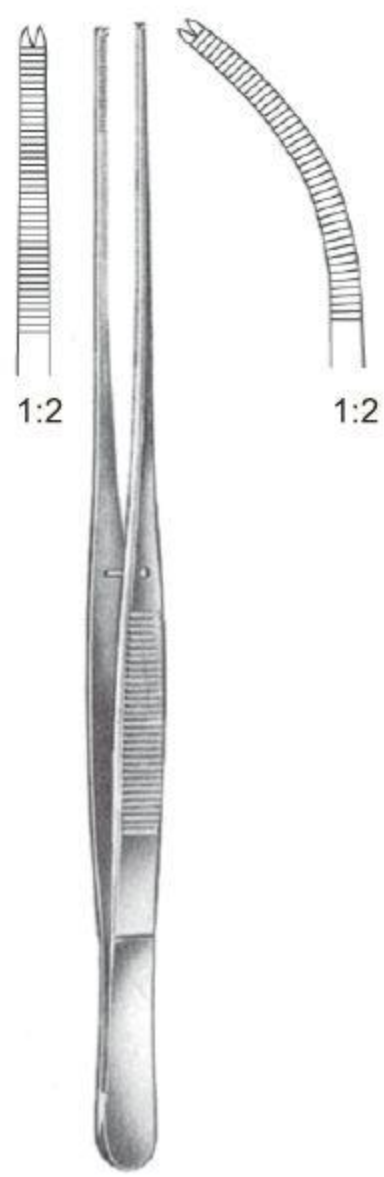

Brophy
 06-1956-20 20.0cm 06-1957-20

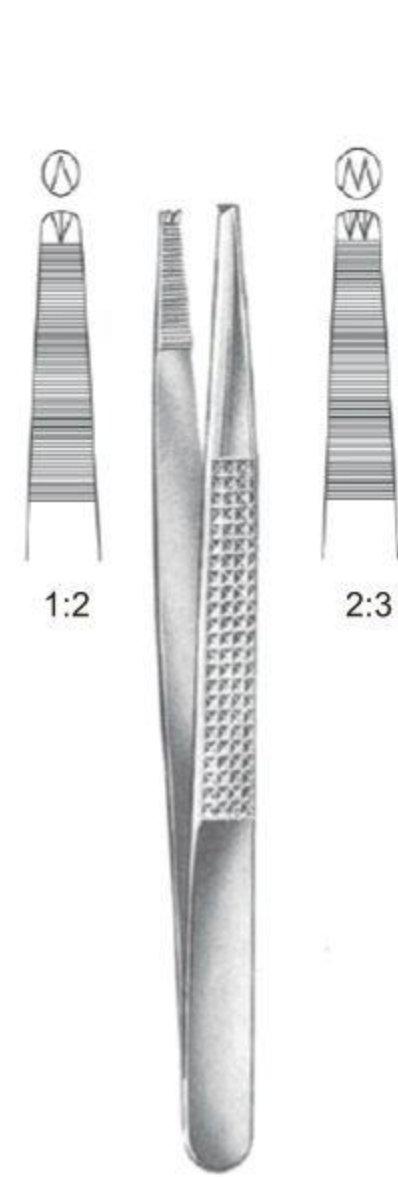

Bonney
 06-1958-18 18.0cm 06-1959-18



Adson
06-1960-18 18.0cm



Jefferson
06-1961-18 18.0cm

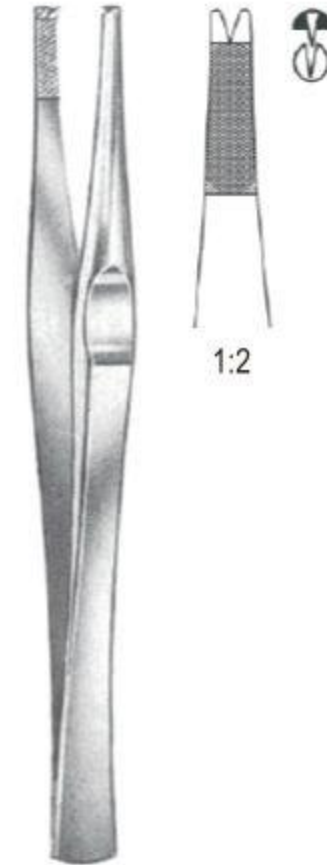

Lanes
06-1962-12 12.5cm
06-1962-15 15.0cm
06-1962-18 18.0cm
06-1962-20 20.0cm



Lanes
06-1963-12 12.5cm
06-1963-15 15.5cm
06-1963-18 18.0cm
06-1963-20 20.0cm

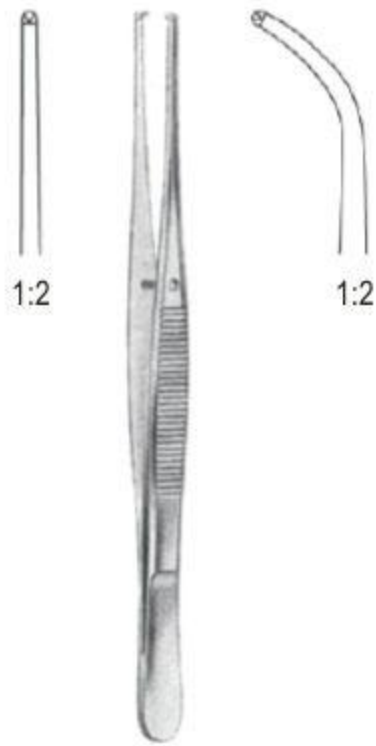

Semken
06-1964-12 12.5cm 06-1965-12 12.5cm
06-1964-15 15.0cm 06-1965-15 15.0cm

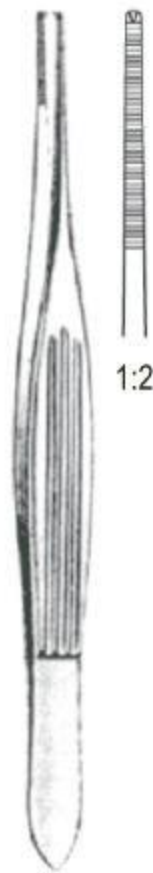

McIndoe

06-1966-15 15.0cm 06-1967-15 15.0cm

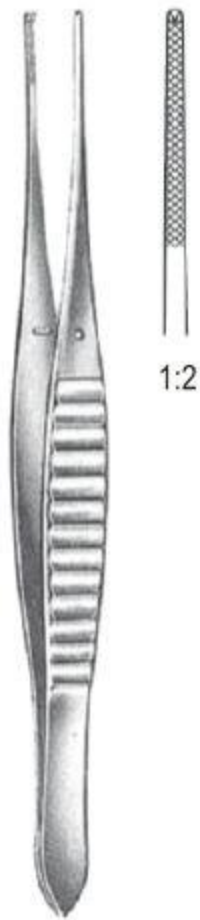

Gillies

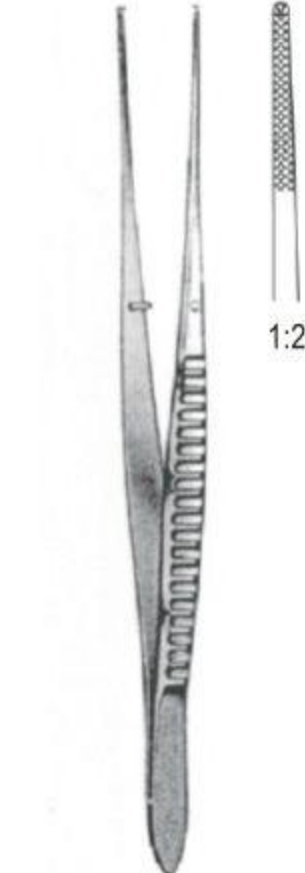

Waugh

06-1968-15 15.0cm
06-1968-18 18.0cm
06-1968-20 20.0cm



Potts Smith

06-1969-18 18.0cm
06-1969-21 21.0cm
06-1969-25 25.0cm
06-1969-30 30.0cm

Tissue Forceps ●— EN
 Chirurgische Pinzetten ●— DE
 Pinzas de diseccion con dientes ●— ES

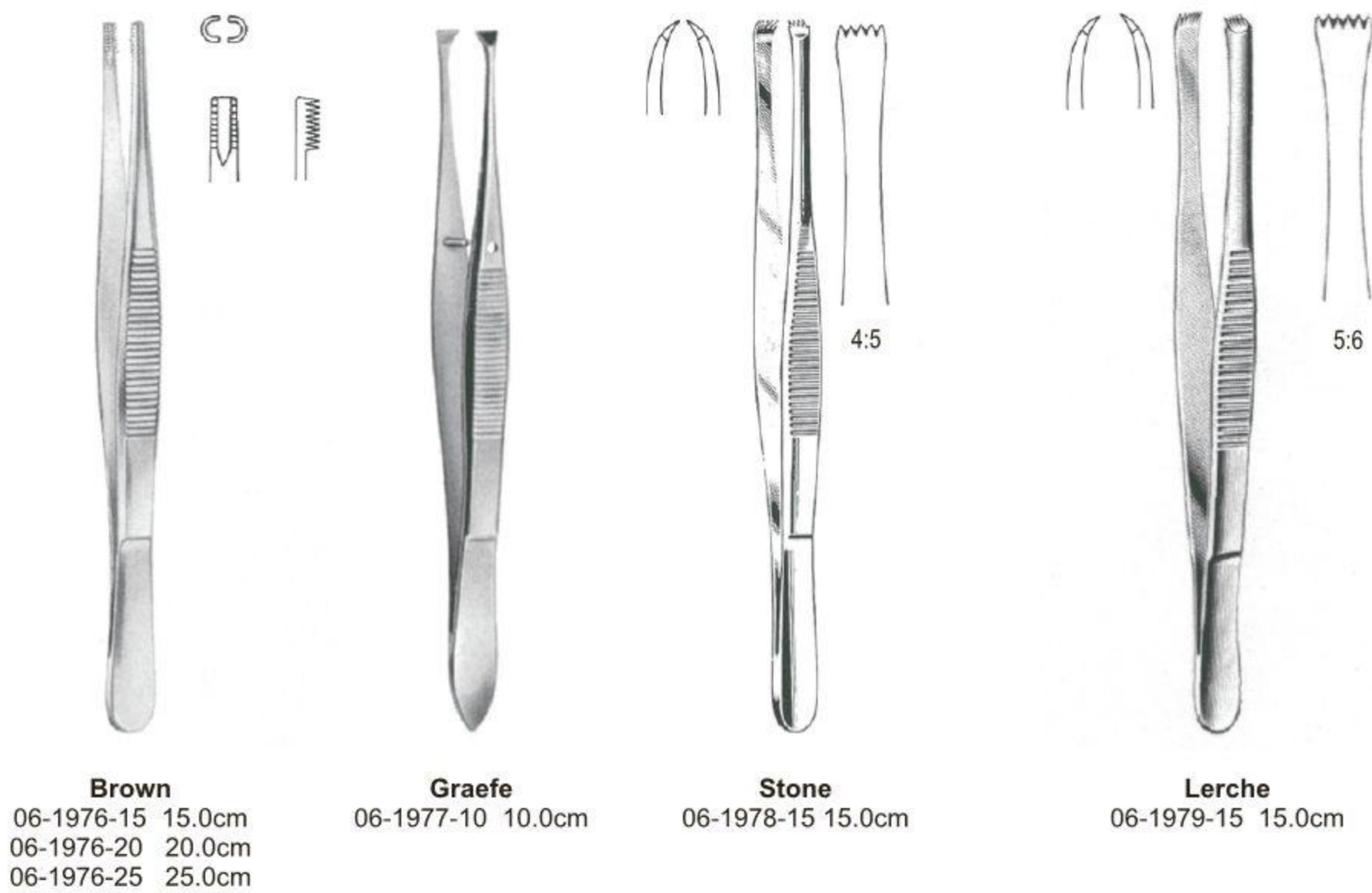
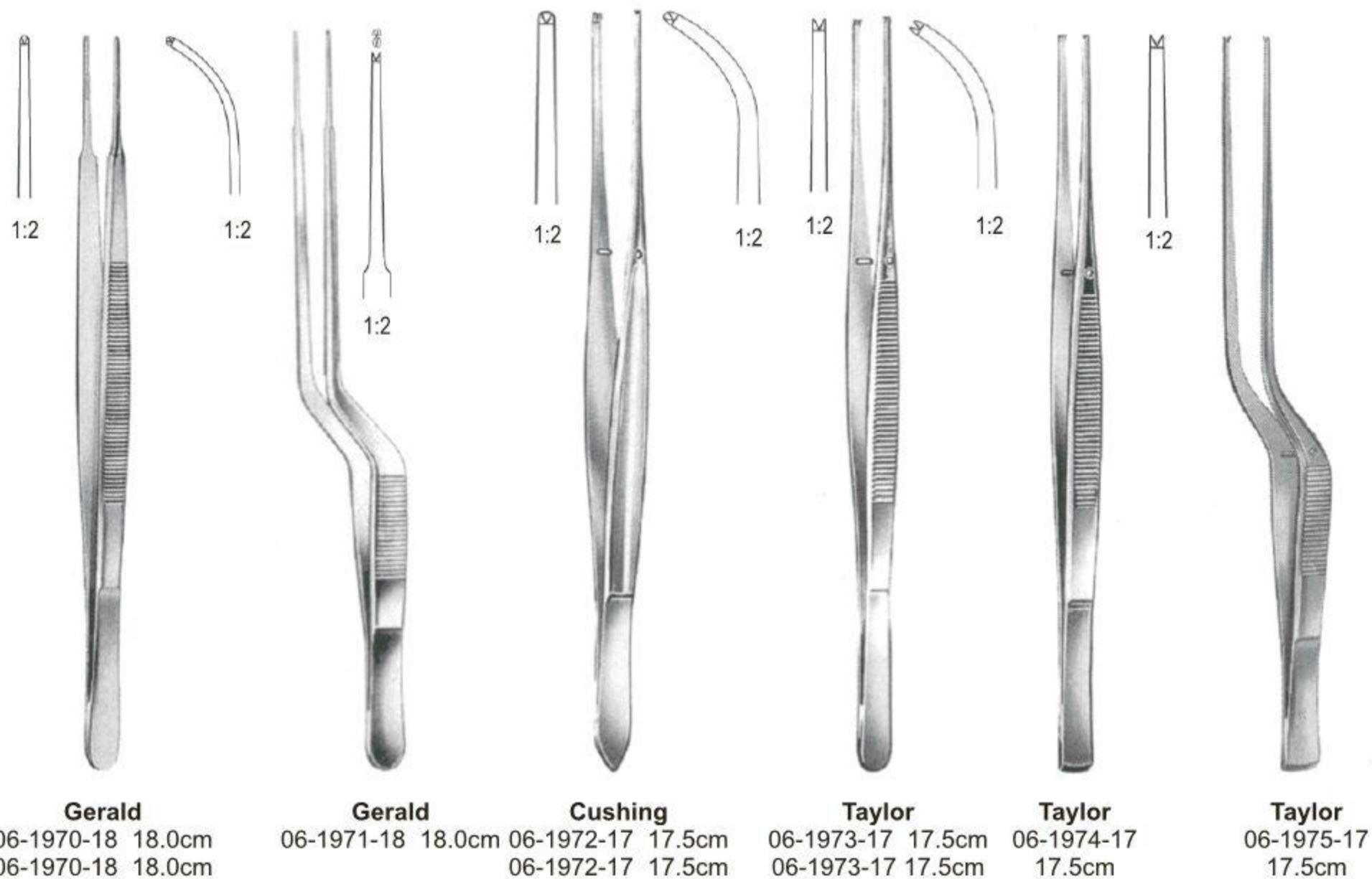

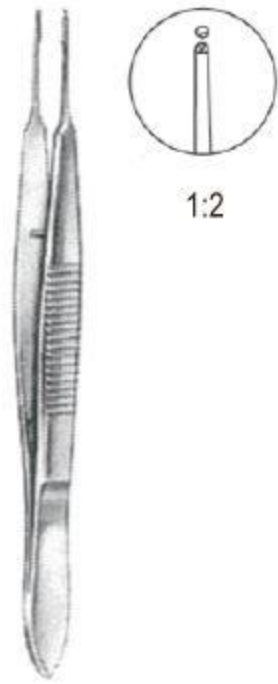

06-1980-11
11.0cm

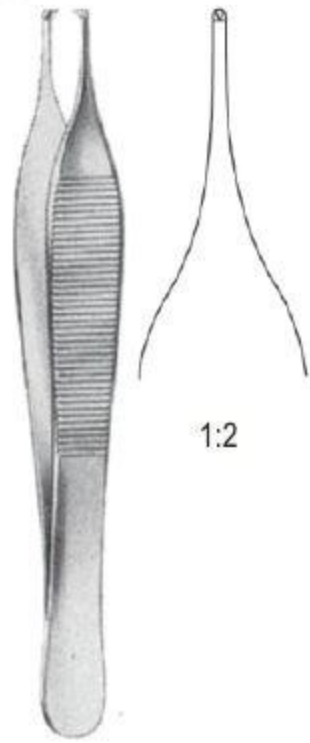

Adson
06-1981-12 12.0cm
06-1981-15 15.0cm

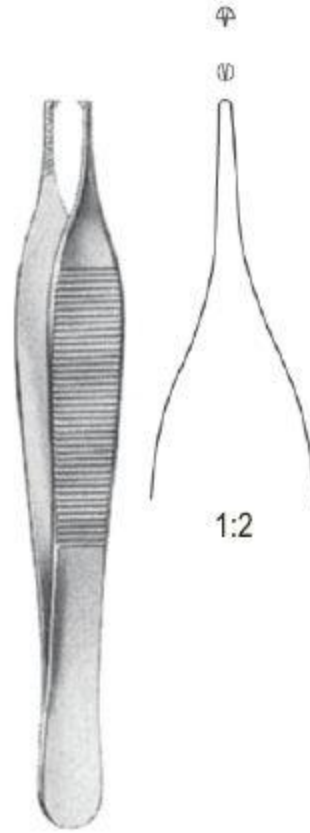

Adson
06-1982-12 12.0cm

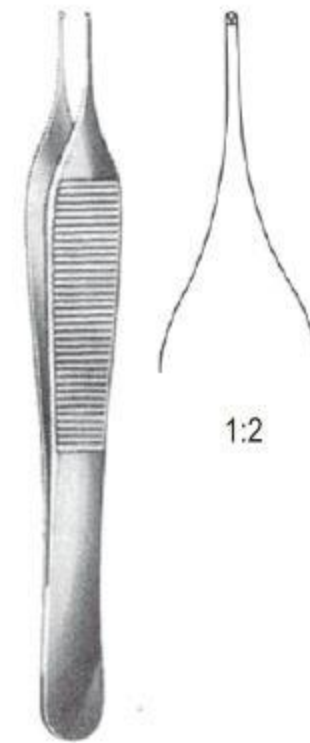

Micro-Adson
06-1983-12 12.0cm



Adson-Brown
06-1984-12 12.0cm



Durante



06-1985-14
14.5cm



06-1985-16
16.0cm



06-1985-20
20.0cm



Russ Modell



06-1986-15
15.0cm



06-1986-20
20.0cm



06-1986-25
25.0cm



Mayo Russ
06-1987-23 23.0cm

Tissue, Tumor Forceps ●— EN
 Chirurgische, Fasspinzetten ●— DE
 Pinzas, para coger diseccion con dientes ●— ES

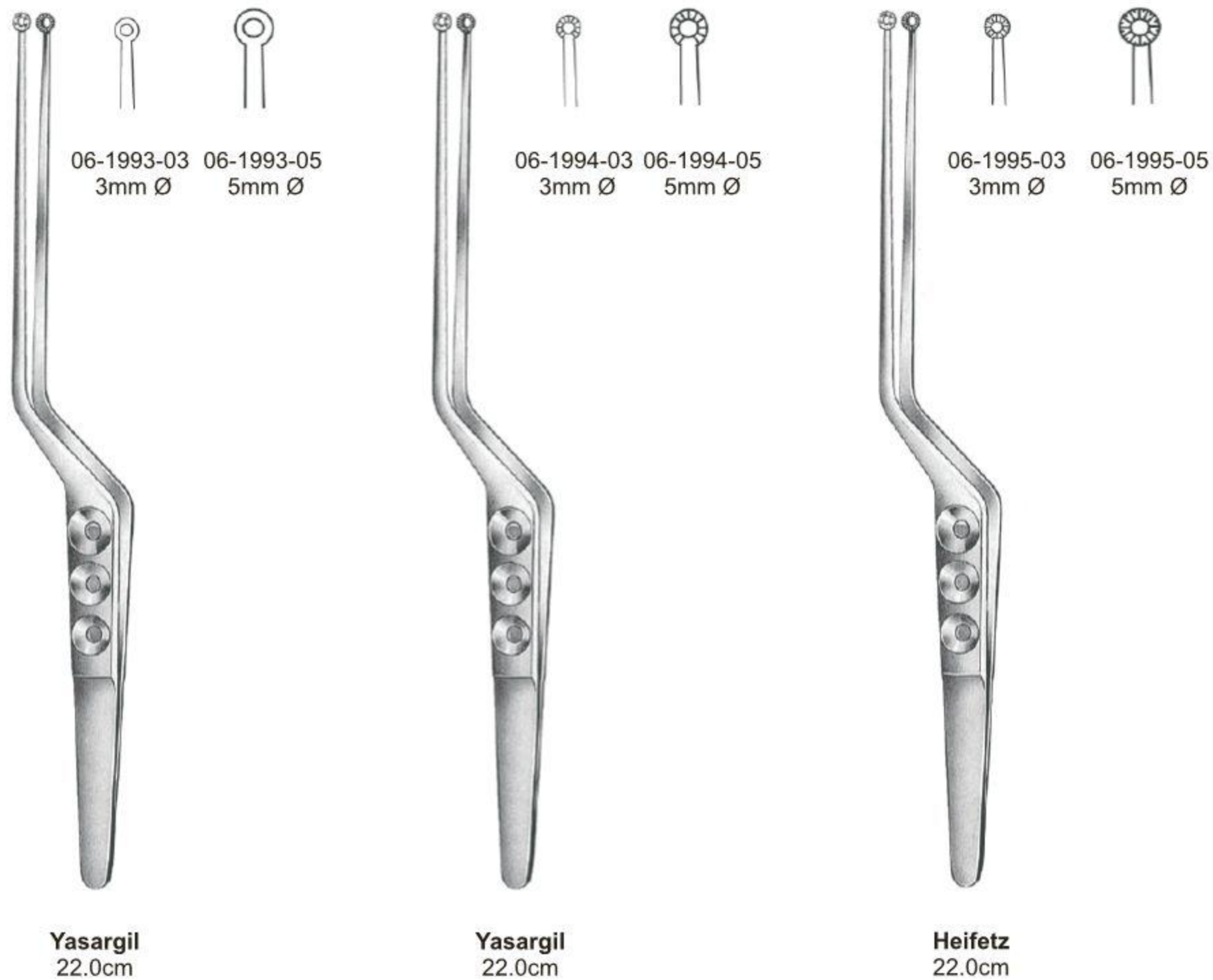
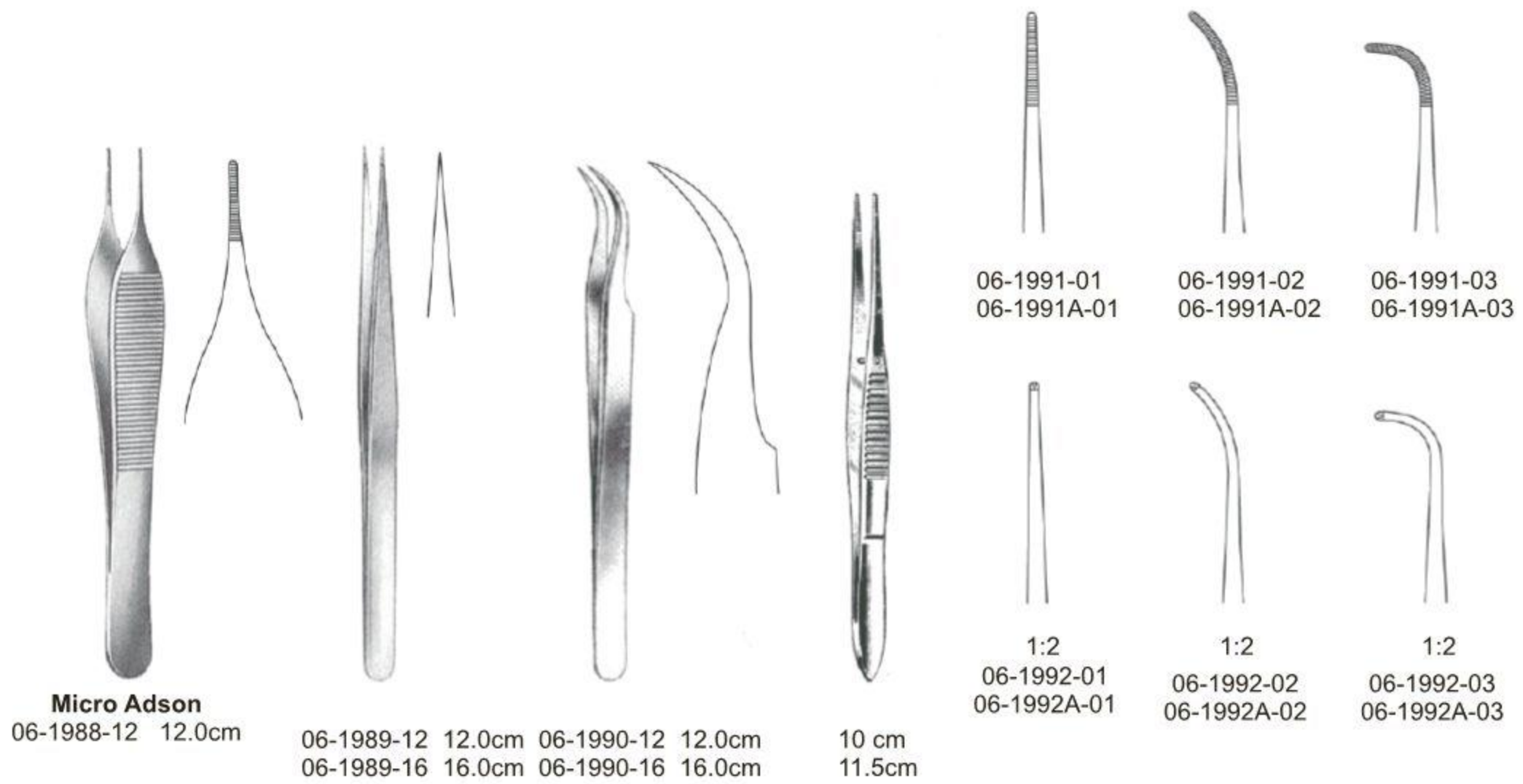

EN —● Tissue and Micro Forceps, Fine Pattern
 DE —● Chirurgische und Mikro-Pinzetten, feine modelle
 ES —● De diseccion con dientes micro-pinzas, modelos finos

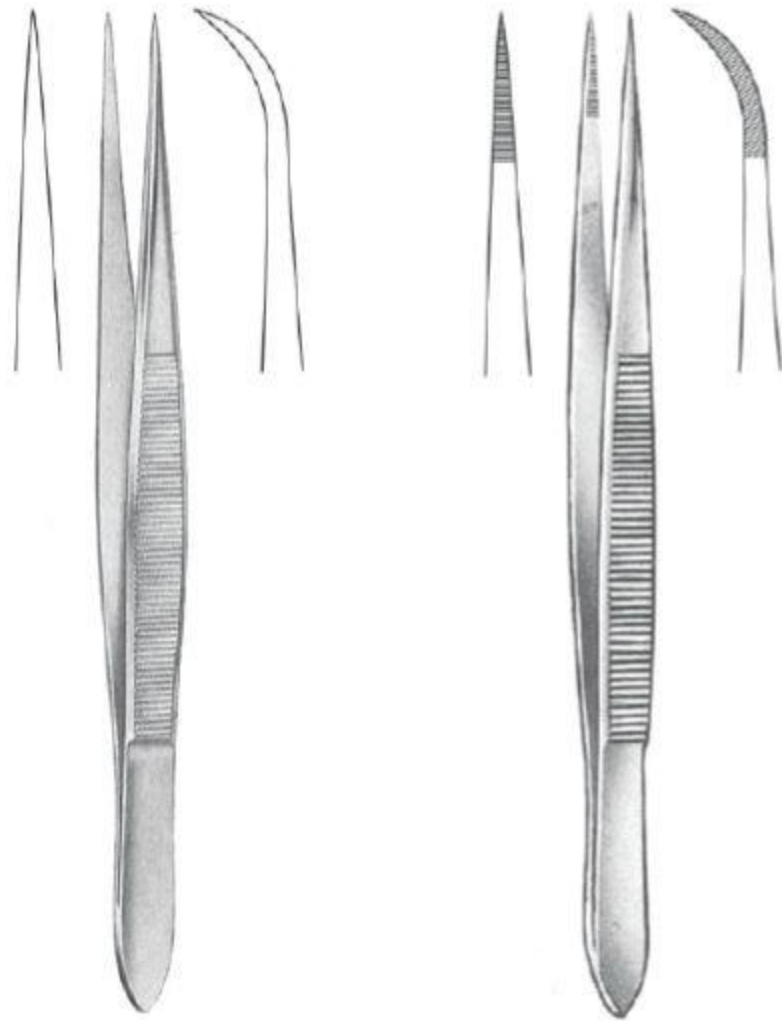

06-1996-09	09.0cm	06-1997-09	06-1998-09	09.0cm	06-1999-09
06-1996-10	10.5cm	06-1997-10	06-1998-10	10.5cm	06-1999-10
06-1996-11	11.5cm	06-1997-11	06-1998-11	11.5cm	06-1999-11
06-1996-12	12.0cm	06-1997-12	06-1998-12	12.0cm	06-1999-12

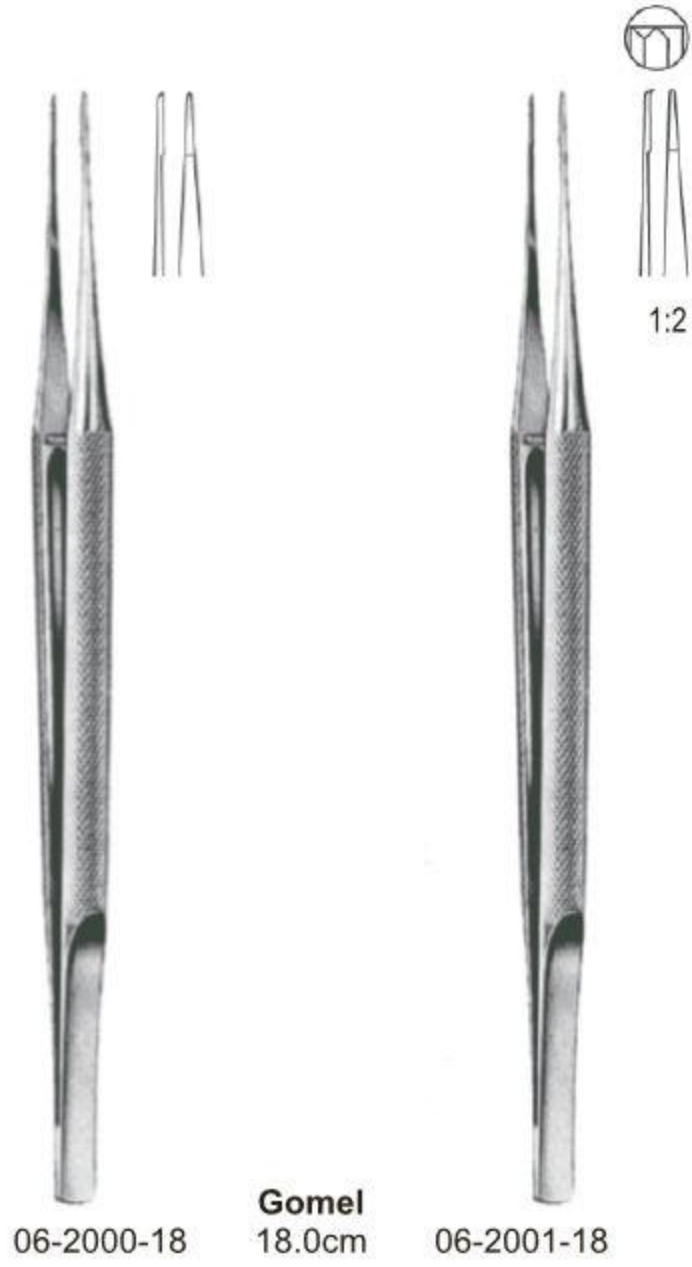

06-2000-18 **Gomel** 18.0cm 06-2001-18



06-2002-01 06-2002-02

22.5cm



06-2003-01 06-2003-02

06-2003-03

18.5cm



06-2004-16

15.5cm

- Splinter Forceps ●— EN
- Spitter-Pinzetten ●— DE
- Pinzas para espinas ●— ES

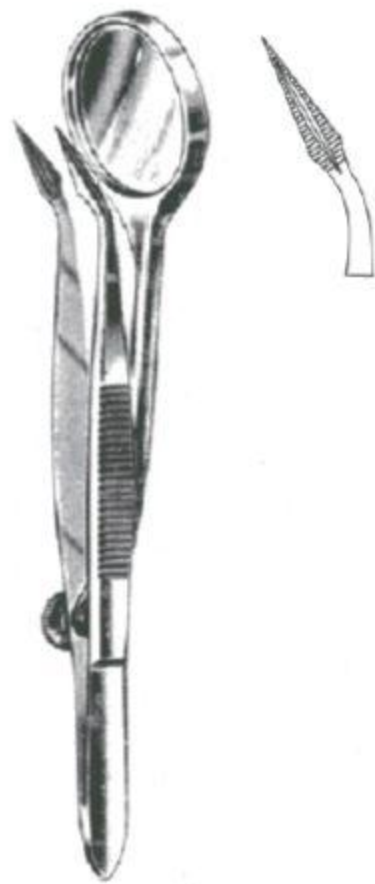

06-2005-12
12.0cm



Feilchenfeld



06-2006-07
7.5cm



06-2006-09
9.0cm



06-2006-20
11.5cm



06-2007-12
12.5cm



06-2008-10



Hunter
10.5cm



06-2009-10



06-2010-10



Walter-Carmalt
10.5cm



06-2011-10

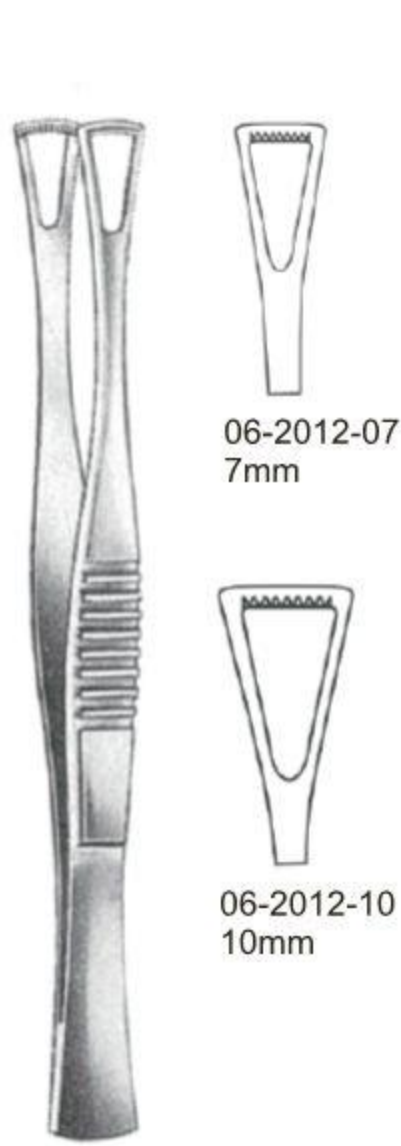

Duval
14.5cm

06-2012-07
7mm

06-2012-10
10mm

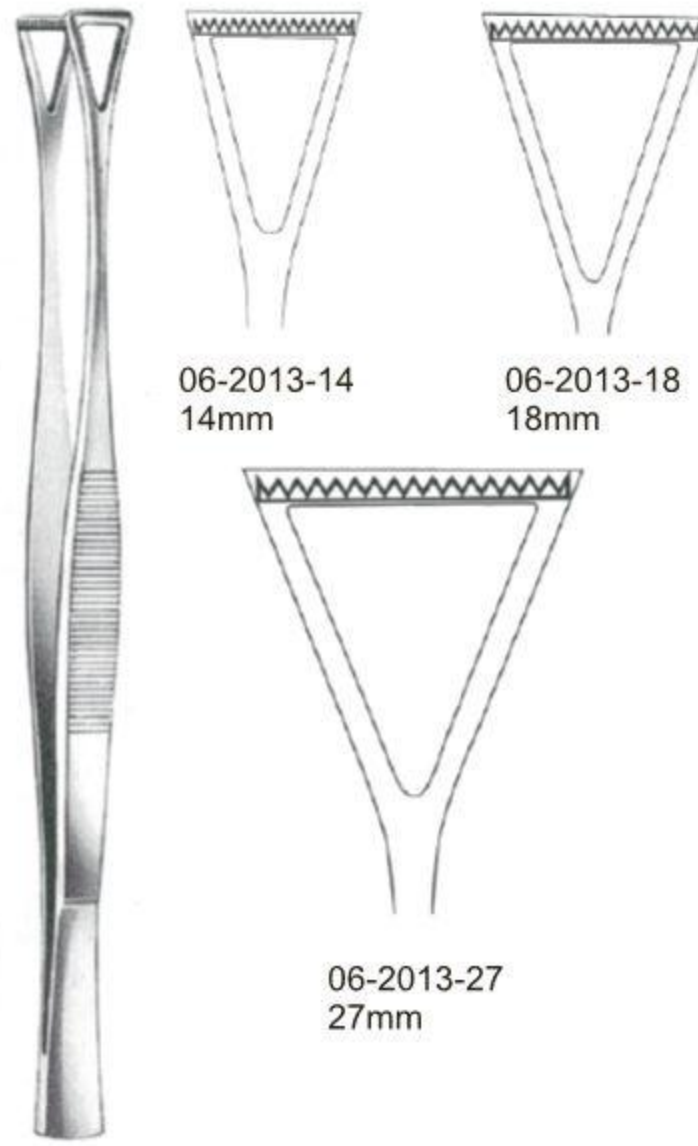

Collin-Duval
20.0cm

06-2013-14
14mm

06-2013-18
18mm

06-2013-27
27mm



Hepp/Scheidel
06-2014-18 18.0cm



Singley-Tuttle
06-2015-23 23.0cm



Nelson
06-2016-23 23.0cm



06-2017-21
21.0cm



Beer
 06-2018-09 9.0cm



Littauer
 06-2019-08 8.5cm



06-2020-09 9.0cm



Douglas
 06-2021-09 9.0cm



Douglas
 06-2022-09 9.0cm



Barraquer
 06-2023-10 10.5cm



Gradle
 06-2024-09 9.5cm



Henry
 06-2025-12 12.0cm



Peet
06-2026-11 11.5cm

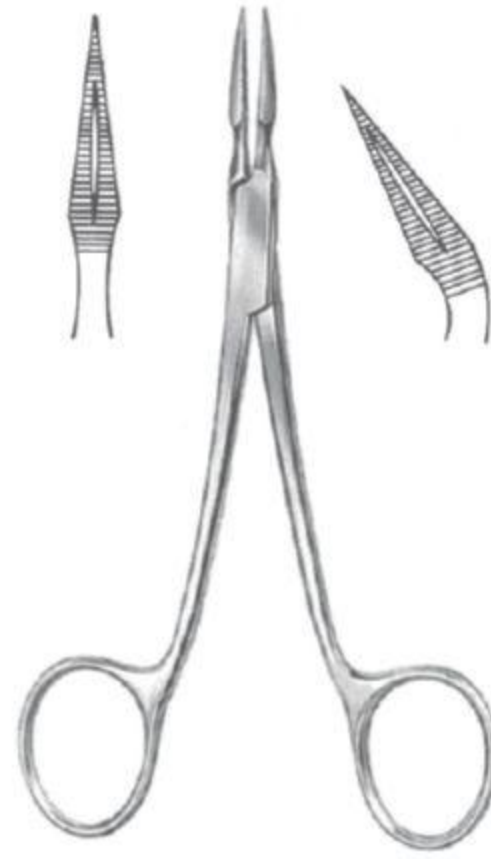

Arther
06-2027-14 14.0cm 12.0401.14

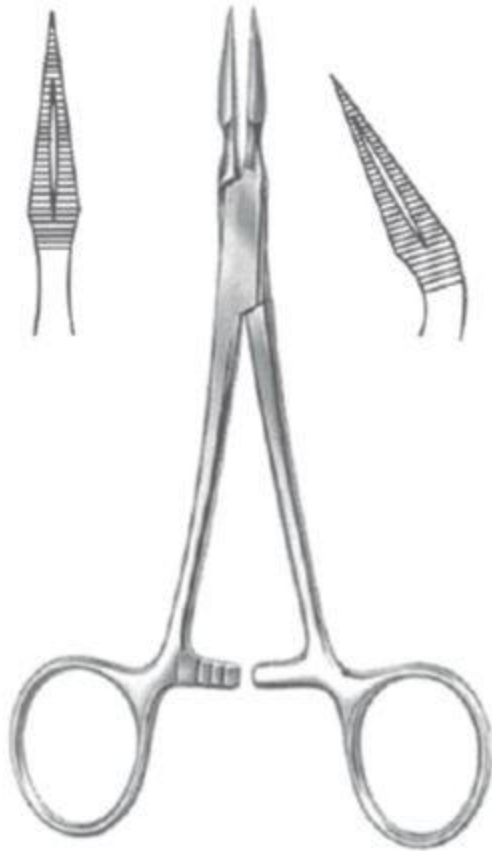

Stieglitz
06-2028-13 13.5cm 06-2029-13

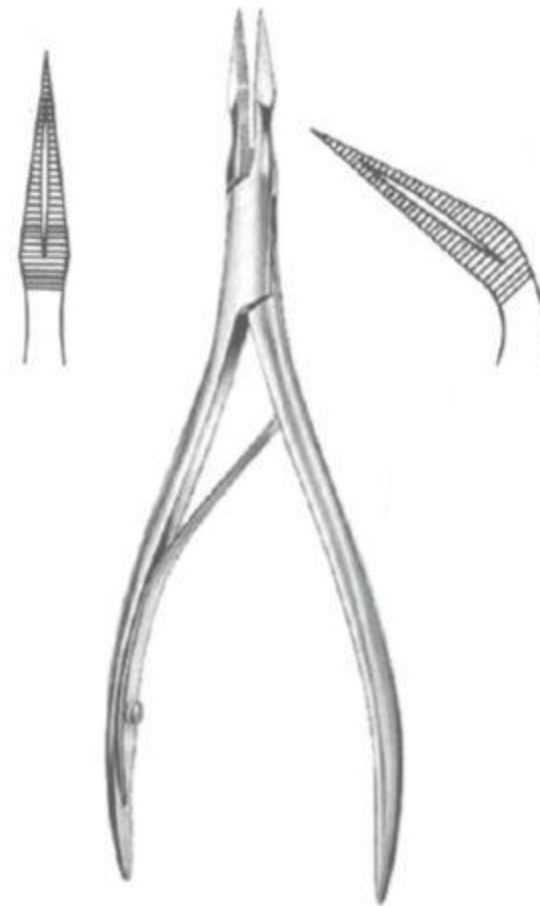

Ralk
06-2030-15 15.0cm 06-2031-15

Dressing Forceps ●— EN
 Anatomische Pinzetten ●— DE
 Pinzas de diseccion ●— ES

**Standard**

06-2032-14 14.5cm/5 ¾"
 06-2032-16 16cm/6 ¼"
 06-2032-18 18cm/7"
 06-2032-20 20cm/8"
 06-2032-25 25cm/10"

**Adson**

06-2033-12 12cm/4 ¾"
 06-2033-15 15.5cm/6"

**McIndoe**

06-2034-15
 15cm/6"

**Semken**

06-2035-12 12cm/4 ¾"
 06-2035-15 15cm/6"



06-2036-18
 18cm/7"



Cushing
 06-2037-18
 18cm/7"



Cushing-Taylor
 06-2038-18
 18cm/7"



Grunwald
 06-2039-18
 18cm/7"



Wangensteen
06-2040-15 15cm/6"
06-2040-23 13cm/9"
06-2040-25 25cm/10"



06-2041-15 15cm/6"
06-2041-18 18cm/7"
06-2041-20 20cm/8"
06-2041-23 23cm/9"
06-2041-25 25cm/10"



Oehler
1:2
06-2042-14 14.5cm/5 1/2"
06-2042-16 16cm/6 1/4"
06-2042-18 18cm/7"
06-2042-20 20cm/8"
06-2042-25 25cm/10"
06-2042-30 30cm/12"



Micro-Adson
06-2043-12 12cm/4 3/4"
06-2043-15 15.5cm/6"



Standard-Adson
06-2044-12 12cm/4 3/4"
06-2044-15 15.5cm/6"



Adson-Brown
06-2045-12
12cm/4 3/4"



Gillies
06-2046-15
15 cm/6"

- EN** Artery Forceps
- DE** Arterienklemmen
- ES** Pinzas hemostáticas

Page 112 to 140





Terrier
07-2101-10
10 cm/4"



Pennington
07-2102-15 15 cm/6"
07-2102-20 20 cm/8"



Pean
07-2103-12
12.5 cm/5"

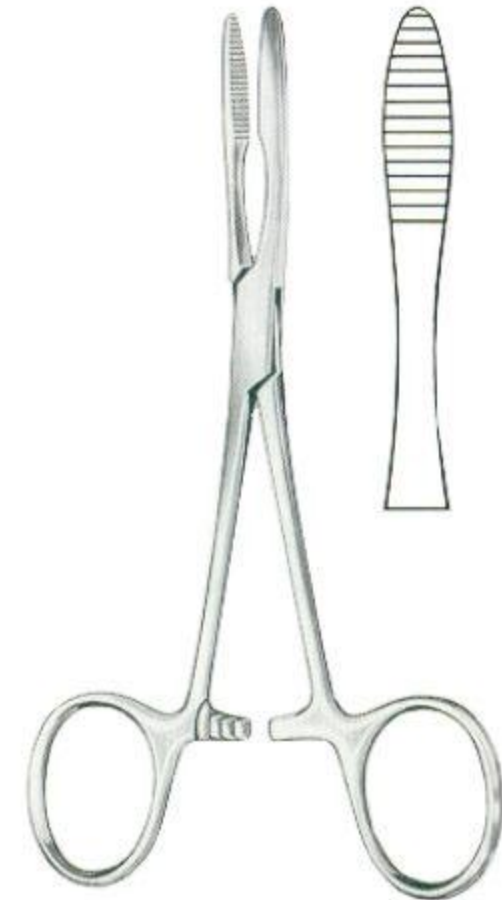

Pean
07-2104-14 14 cm/5 3/4"
07-2104-16 16 cm/6 1/4"



Pean
07-2105-14
14 cm/5 1/2"



Collin
07-2106-15
15.5 cm/6"



Collin
07-2107-14
14 cm/5 1/2"



Collin
07-2108-16
16.5 cm/6 1/2"



Hartmann
 10 cm/4"



Halstead-Mosquito
 12 cm/4¾"
 14 cm/5½"



Micro-Mosquito
 10 cm/4"
 12 cm/4¾"



Jacobson-Halstead
 13 cm/5"



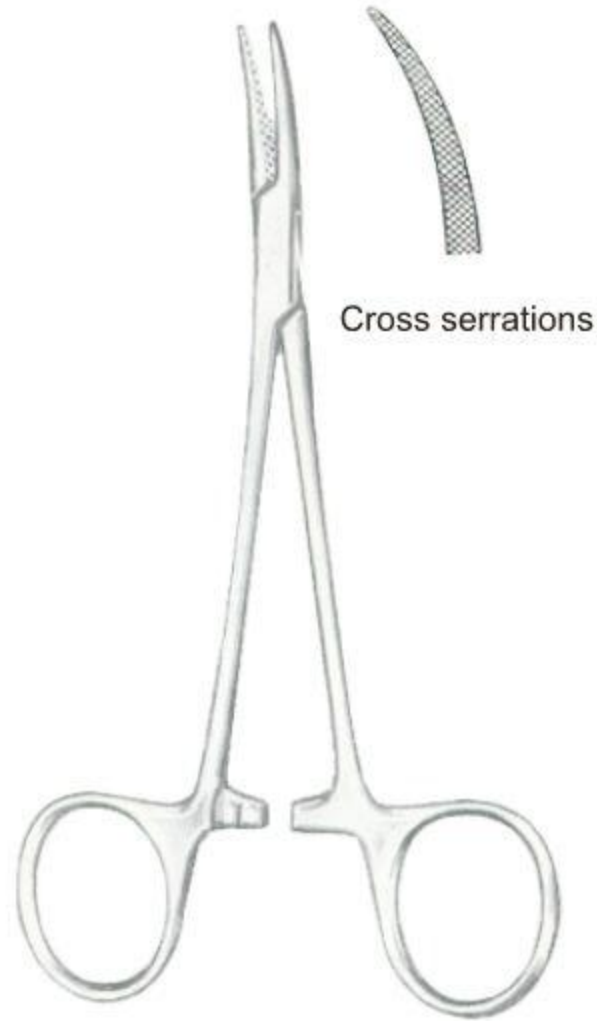

Cross serrations

07-2123-12
12 cm/4¾"



Halstead-Mosquito
18 cm/7"
21 cm/8¼"



07-2124-18
07-2124-21



07-2125-18
07-2125-21



07-2126-18
07-2126-21



07-2127-18
07-2127-21



Kelly
14 cm/5½"

Kelly-Rankin
16 cm/6¼"



07-2128-14



14 cm/5½" 07-2129-14



07-2130-16



16 cm/6¼" 07-2131-16



Crile
 14 cm/5½"

Crile-Rankin
 16 cm/6¼"

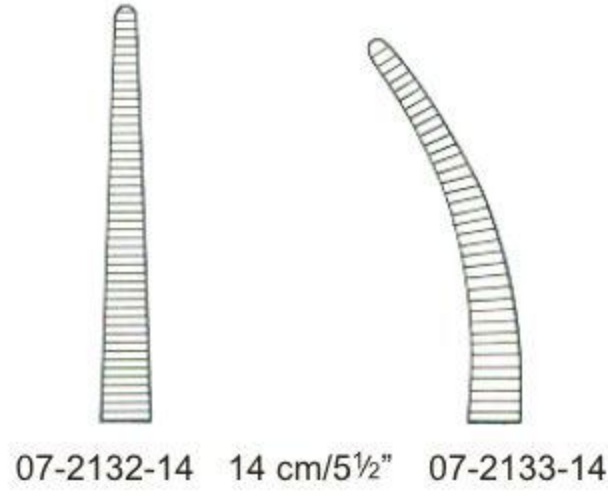

07-2132-14 14 cm/5½" 07-2133-14

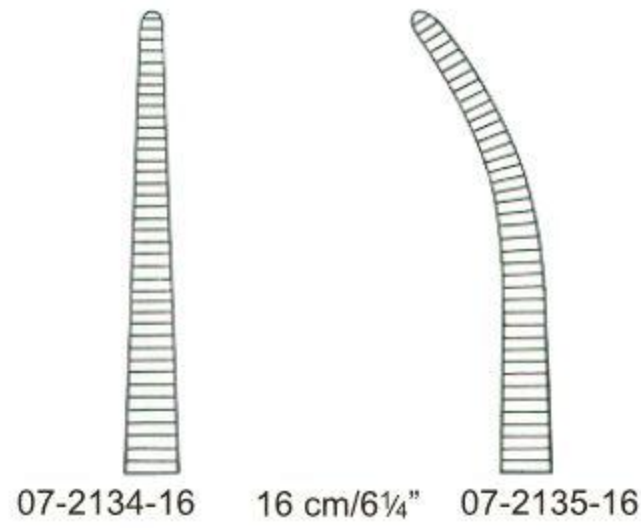

07-2134-16 16 cm/6¼" 07-2135-16



Baby-Crile
 14 cm/5½"

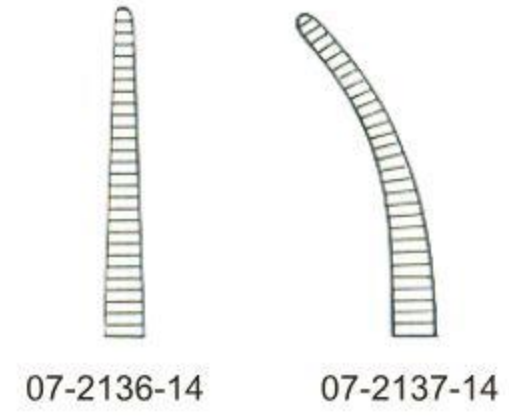

07-2136-14 07-2137-14



Crile
 14 cm/5½"

Crile-Rankin
 16 cm/6¼"

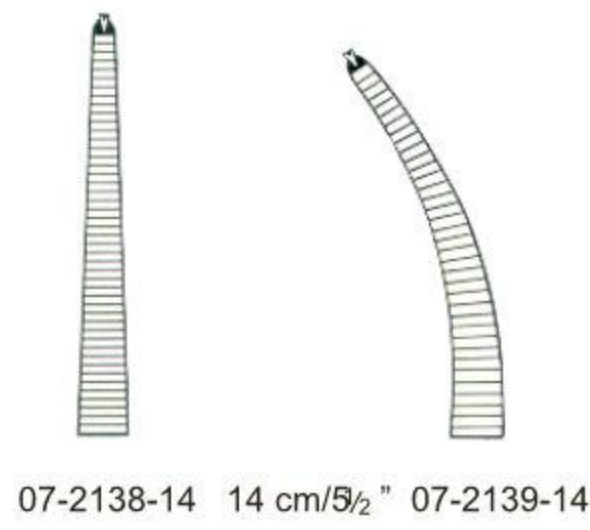

07-2138-14 14 cm/5½" 07-2139-14

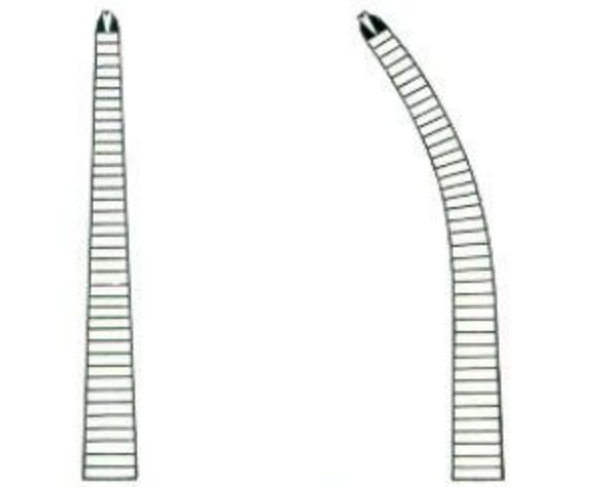

07-2140-16 16 cm/6¼" 07-2141-16



Baby-Crile
 14 cm/5½"

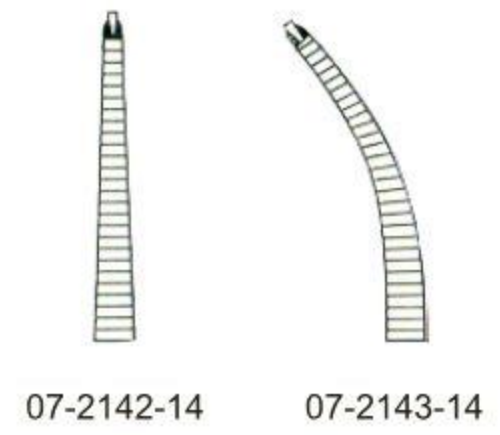

07-2142-14 07-2143-14



Coller-Crile

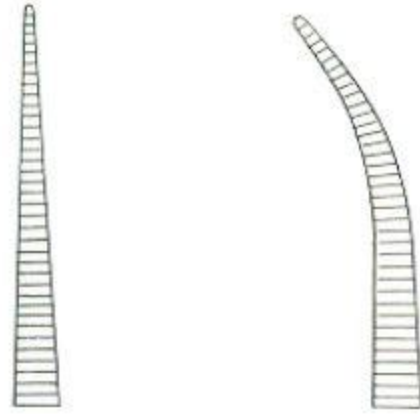

07-2144-14 14 cm/5 1/2" 07-2145-14

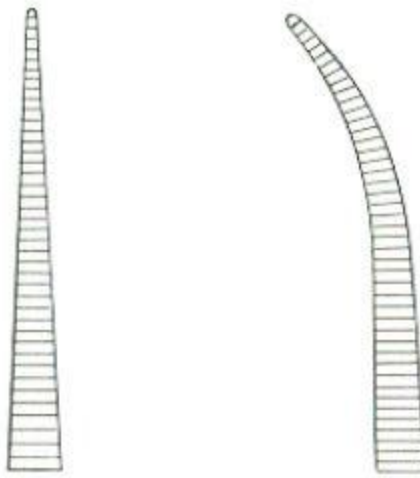

07-2146-16 16 cm/6 1/4" 07-2146-16



Coller-Crile
07-2147-16
16 cm/6 1/4"



Leriche
15 cm/6"



07-2148-15



07-2149-15



07-2150-15



07-2151-15



Providence
14 cm/5 1/2"



07-2152-14



07-2153-14

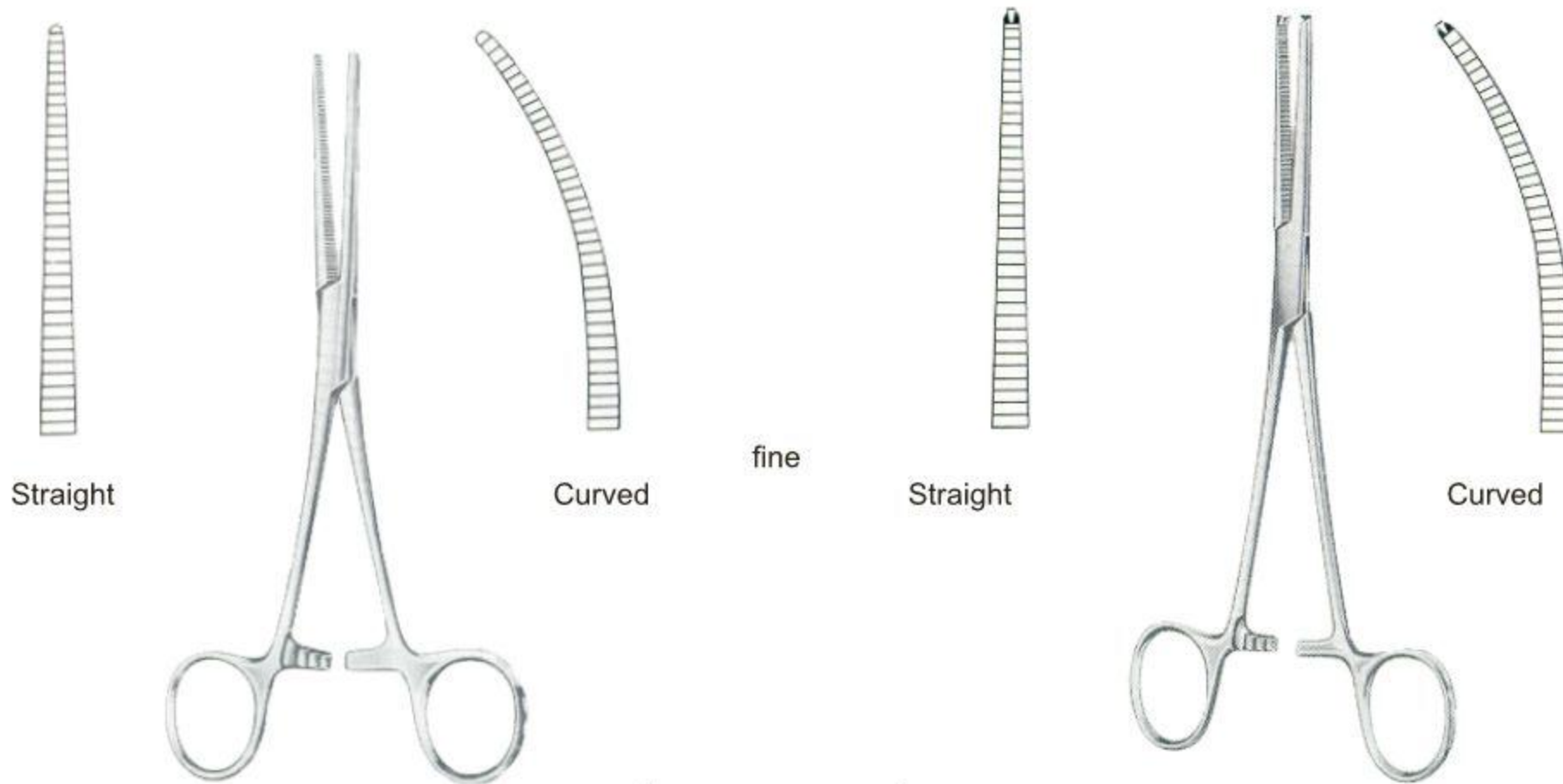

Rochester-Pean		cm	in	Ochsner-Kocher	
07-2154-13	07-2155-13	13.0	5"	07-2156-13	07-2157-13
07-2154-14	07-2155-14	14.0	5 1/2"	07-2156-14	07-2157-14
07-2154-16	07-2155-16	16.0	6 1/4"	07-2156-16	07-2157-16

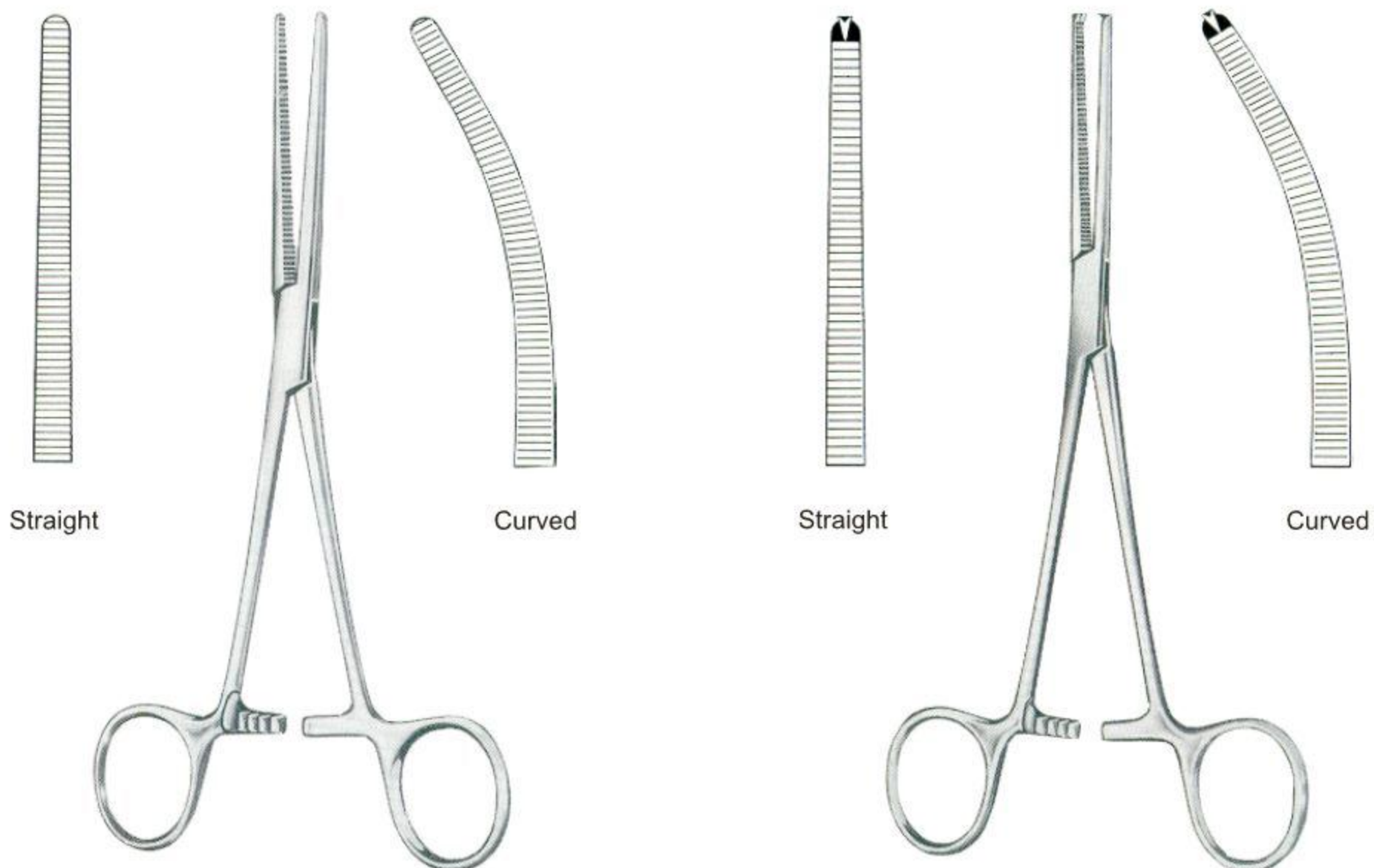

Rochester-Pean		cm	in	Ochsner-Kocher	
07-2158-13	07-2159-13	13.0	5"	07-2160-13	07-2161-13
07-2158-14	07-2159-14	14.0	5 1/2"	07-2160-14	07-2161-14
07-2158-16	07-2159-16	16.0	6 1/4"	07-2160-16	07-2161-16
07-2158-18	07-2159-18	18.0	7"	07-2160-18	07-2161-18
07-2158-20	07-2159-20	20.0	8"	07-2160-20	07-2161-20
07-2158-22	07-2159-22	22.0	8 3/4"	07-2160-22	07-2161-22
07-2158-24	07-2159-24	24.0	9 1/2"	07-2160-24	07-2161-24
07-2158-26	07-2159-26	26.0	10 1/4"	07-2160-26	07-2161-26
07-2158-30	07-2159-30	30.0	12"	07-2160-30	07-2161-30

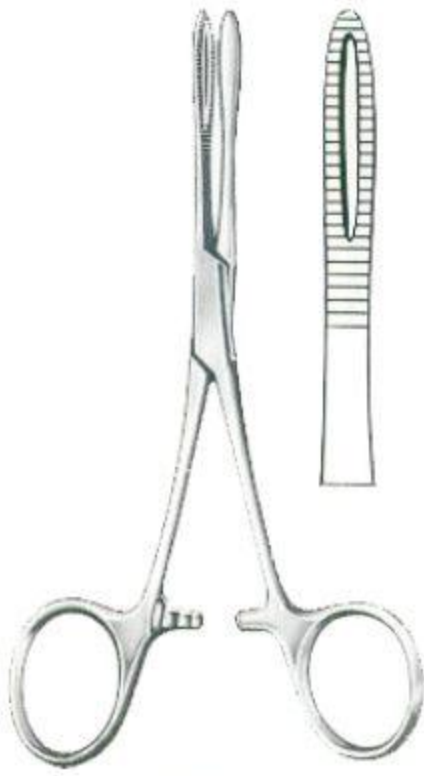

Kronlein
07-2162-13
13cm/5"



Brand
07-2163-15 15cm/6"
07-2163-19 19cm/7 1/2"
07-2163-24 24cm/9 1/2"



Brand
07-2164-15 15cm/6"
07-2164-19 19cm/7 1/2"
07-2164-24 24cm/9 1/2"

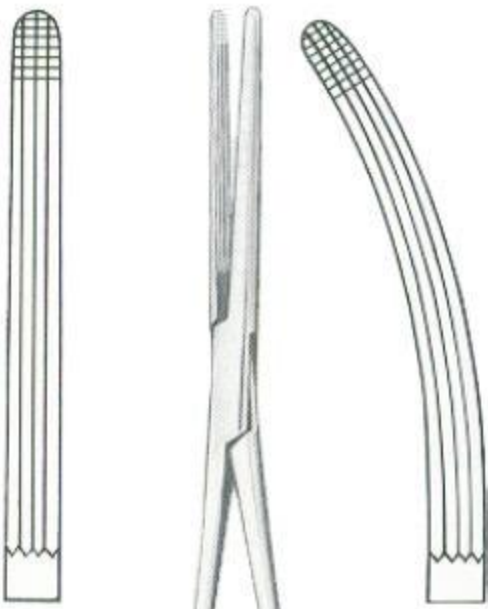

07-2165-16
07-2165-20

07-2166-16
07-2166-20



Rochester-Carmalt
16cm/6 1/4"
20cm/8"

Lateral Curved



07-2167-12



Mosquito-Dandy
12cm/4 3/4"



07-2168-12

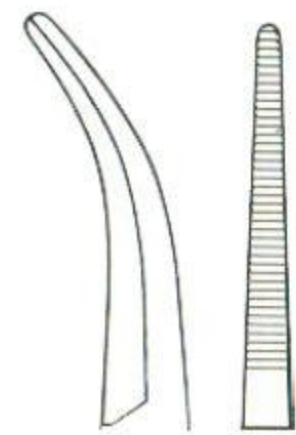

07-2169-14



Dandy
14cm/5 1/2"

07-2170-14



Lovelace
 07-2171-15
 15.5cm/6"



Dixon-Lovelace
 07-2172-16
 16cm/6¼"



Dixon-Lovelace
 07-2173-16
 16cm/6¼"

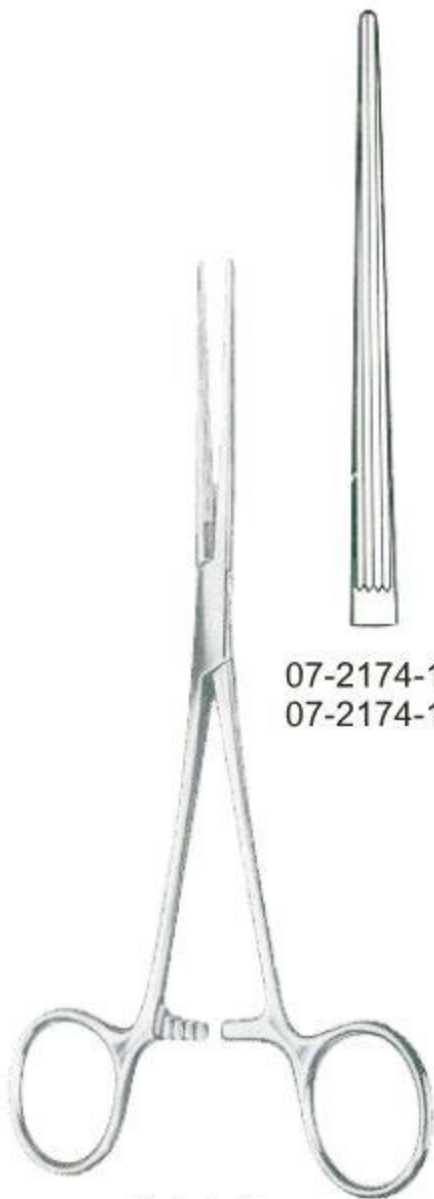

Bainbridge
 15cm/6"
 18cm/7"



Fuchsig
 07-2176-19
 19cm/7½"



Adson
18.5cm/7¼"

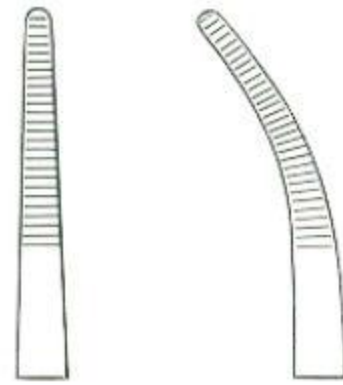

07-2177-18 07-2178-18

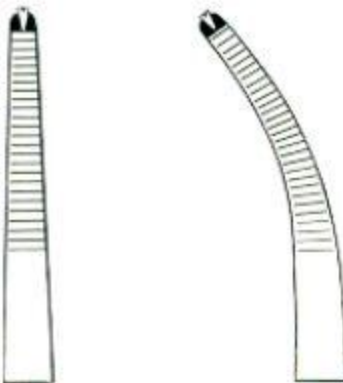

07-2179-18 07-2180-18



Nissen
07-2181-18 18.5cm/7 ¼"
07-2181-22 22.0cm/8 ¾"



Baby-Adson



07-2182-14
14cm/5½"



07-2182-18
18cm/7"

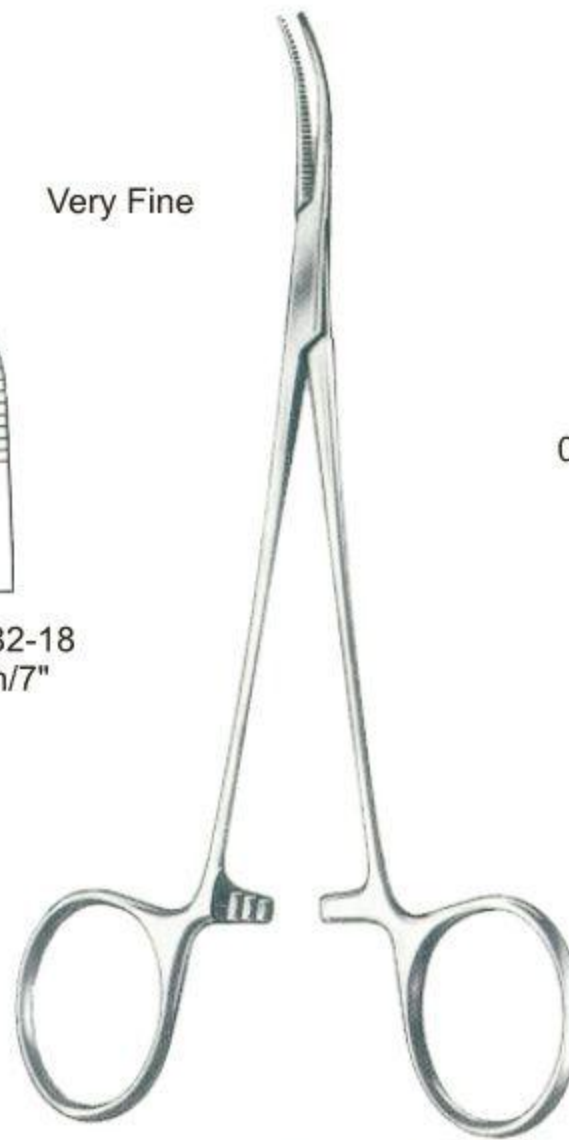

Jacobson-Adson
18cm/7"

Very Fine



07-2183-18



07-2184-18



07-2185-18

Artery Forceps ● EN
 Arterienklemmen ● DE
 Pinzas hemostaticas ● ES

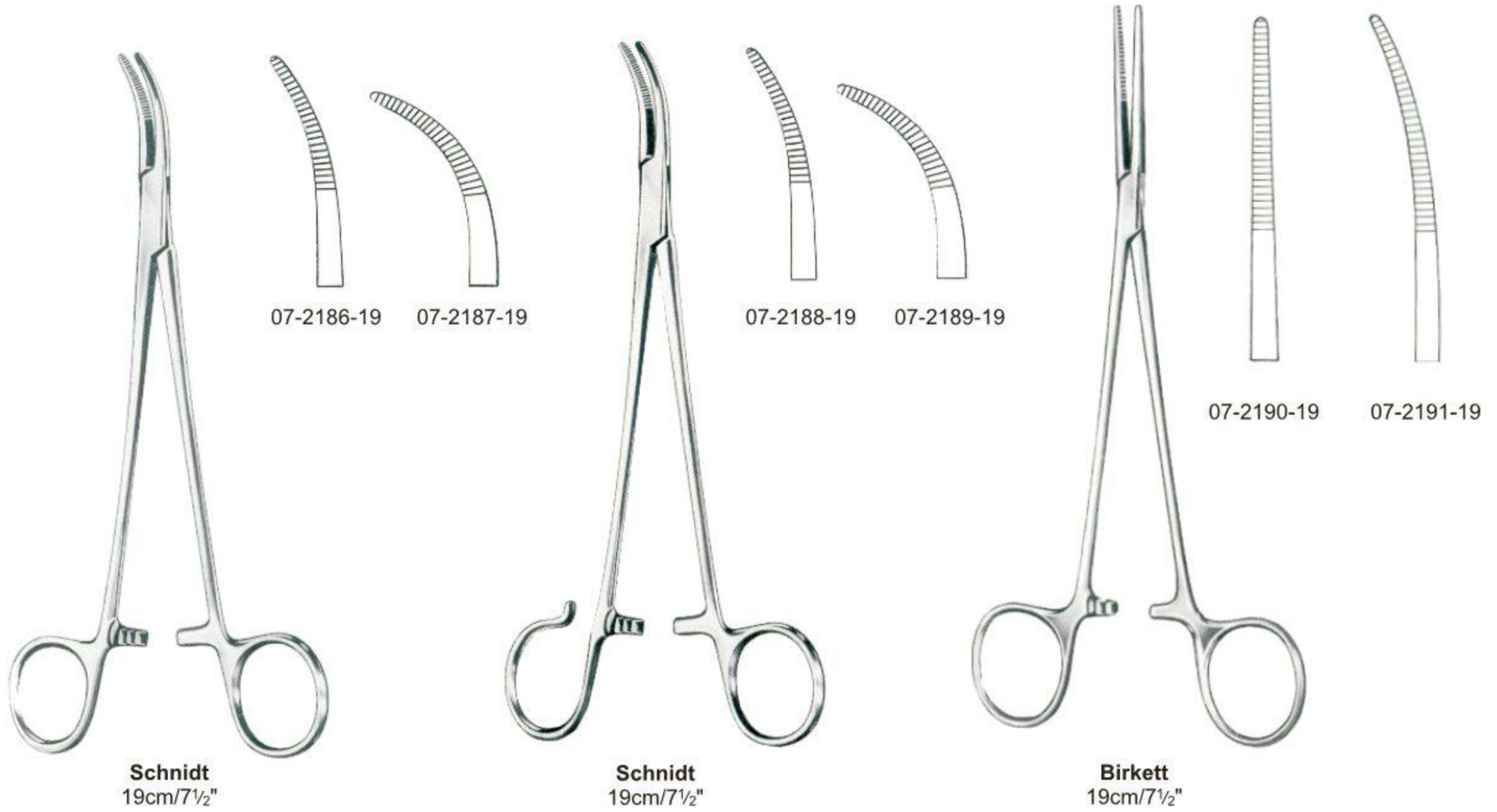

Schnidt
 19cm/7 1/2"

Schnidt
 19cm/7 1/2"

Birkett
 19cm/7 1/2"



Bengolea

20cm/8"	07-2192-20	07-2193-20	07-2194-20	07-2195-20
22cm/8 3/4"	07-2192-22	07-2193-22	07-2194-22	07-2195-22
24cm/9 1/2"	07-2192-24	07-2193-24	07-2194-24	07-2195-24
26cm/10 1/4"	07-2192-26	07-2193-26	07-2194-26	07-2195-26



Bridge
27cm/10½"

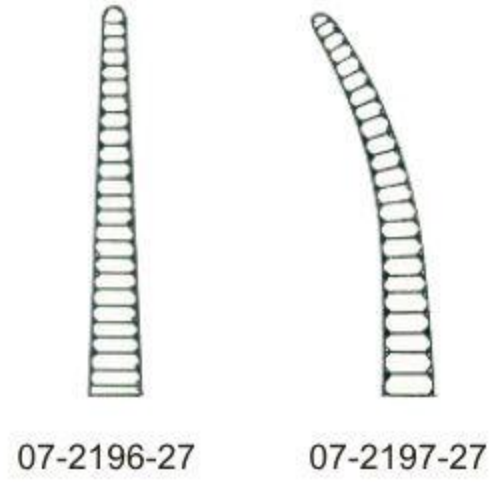

Roberts
22cm/8¾"

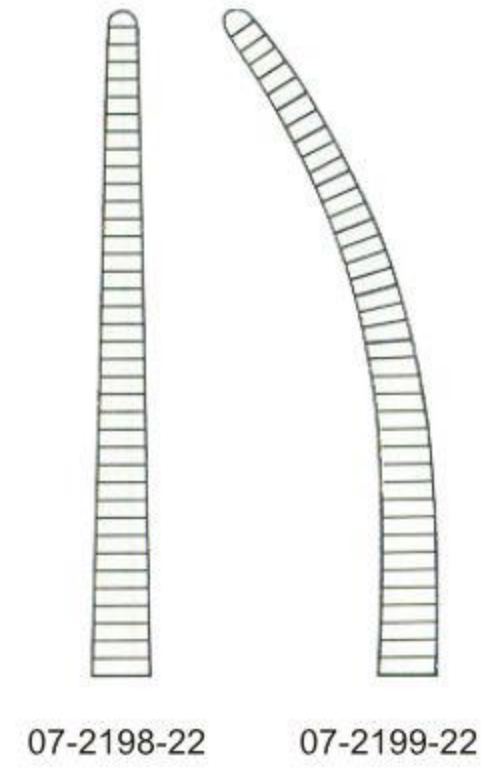

Kelly

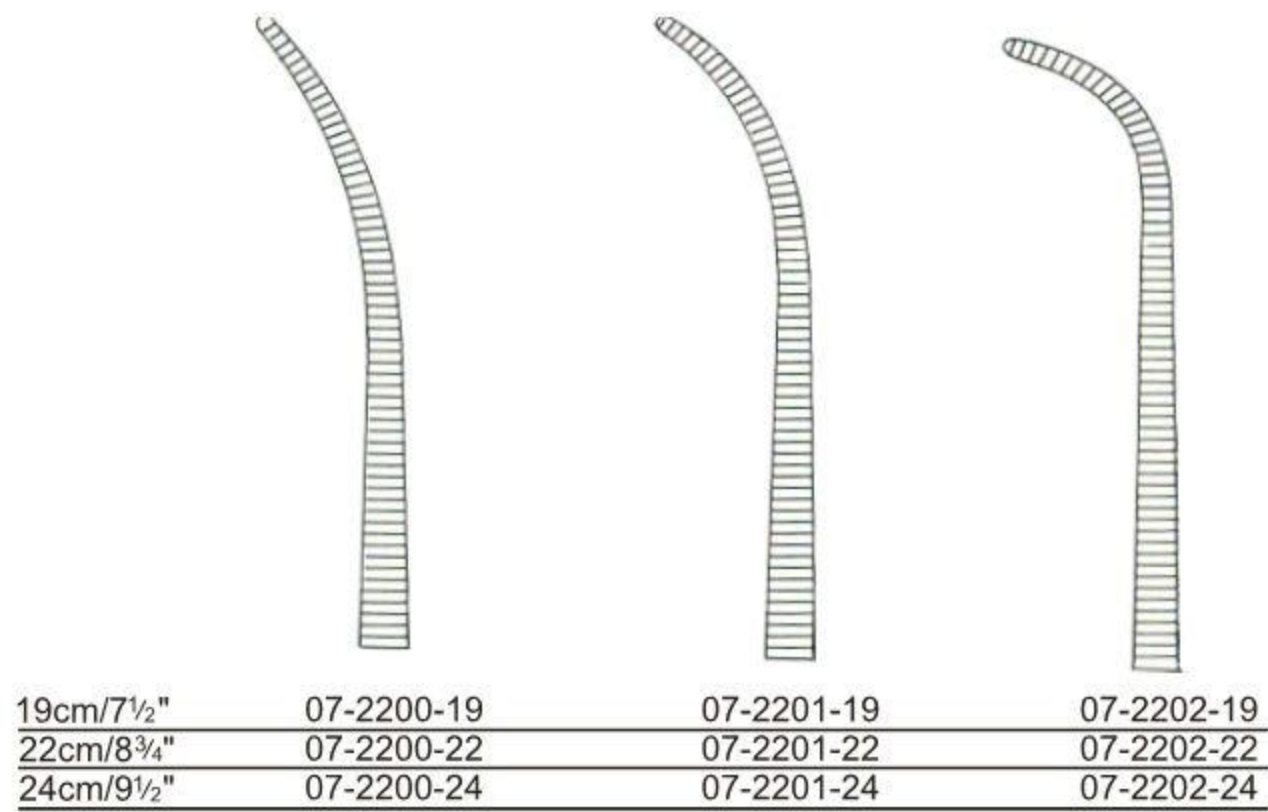



Crafoord-Sellors

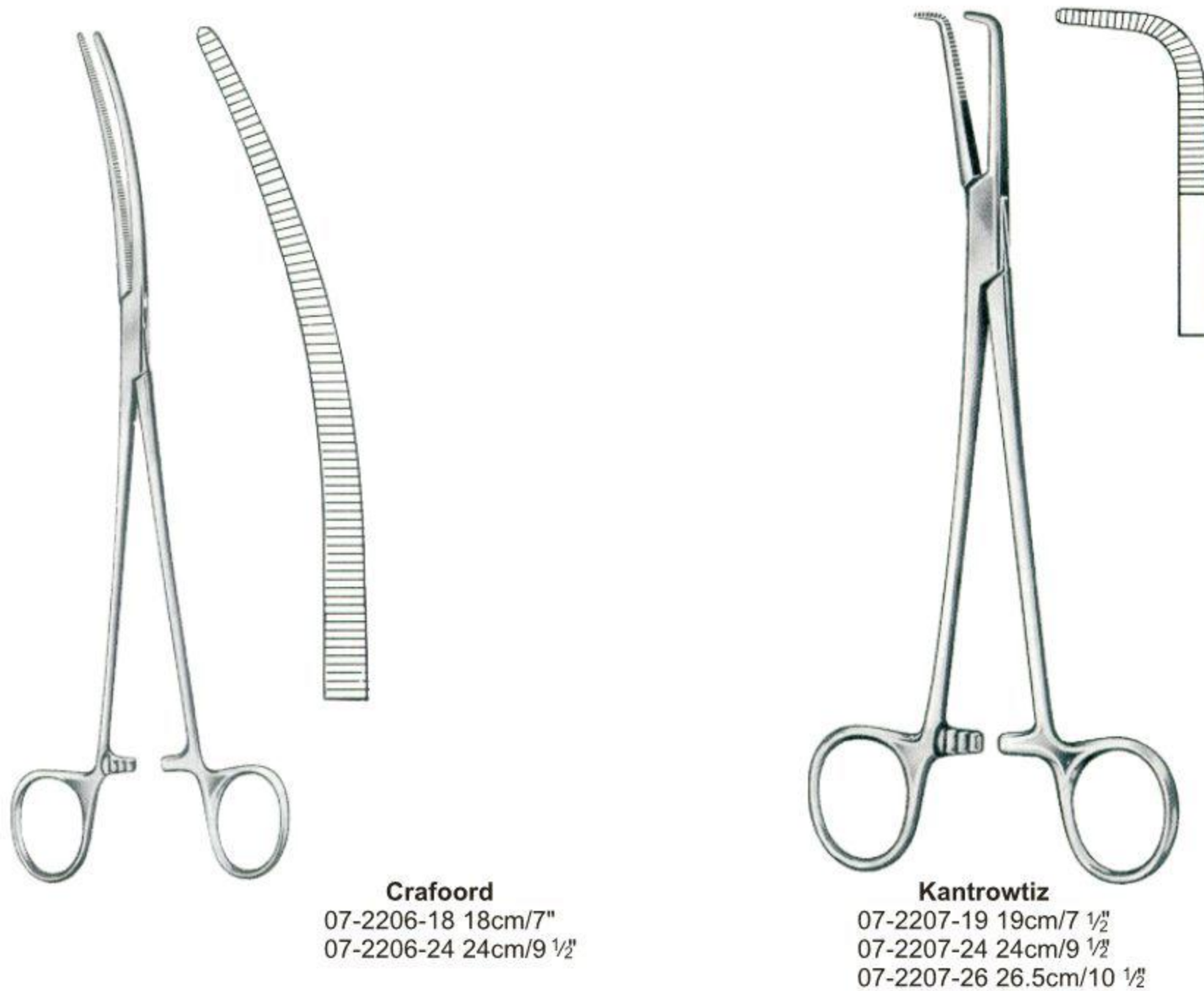



Rumel
23cm/9"



07-2208-23



07-2209-23



07-2210-23



07-2211-23

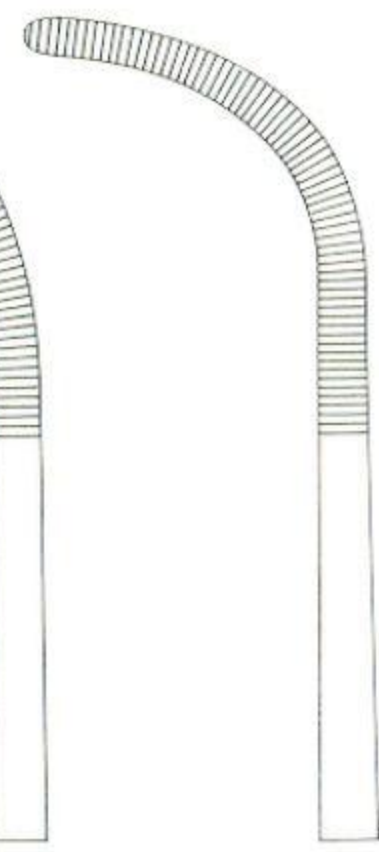

07-2212-23



Johns Hopkins
07-2213-20
20cm/8"



Zenker
29.5cm/11½"



07-2214-29



07-2215-29

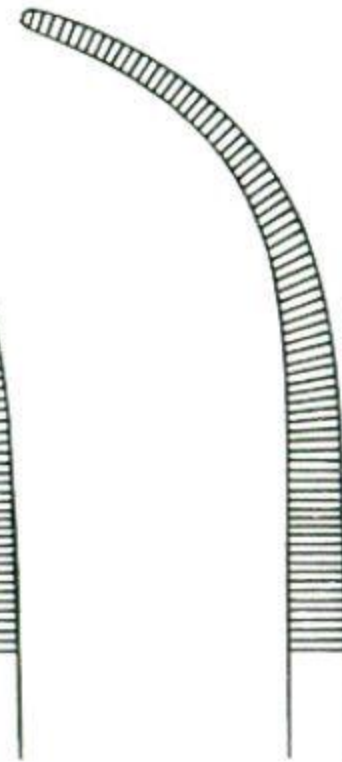

07-2216-29

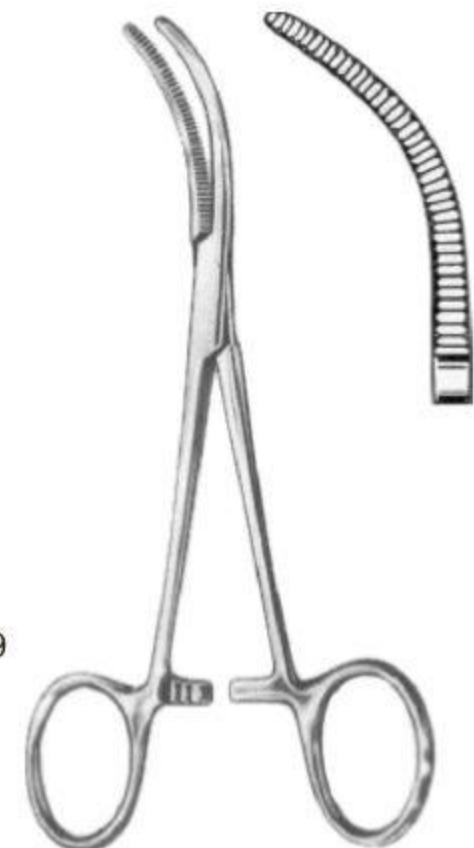

Baby-Overholt
07-2217-13
13.5cm/5¼"

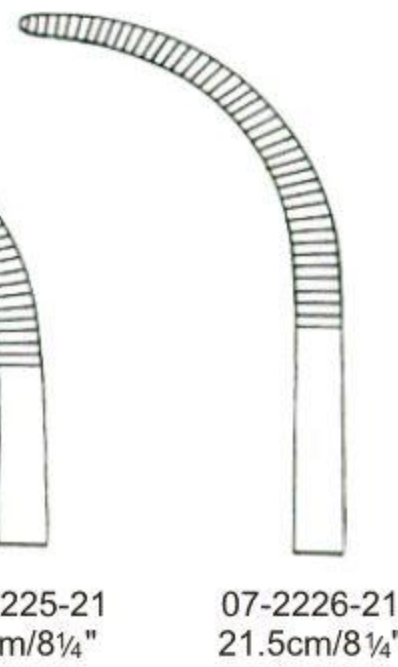
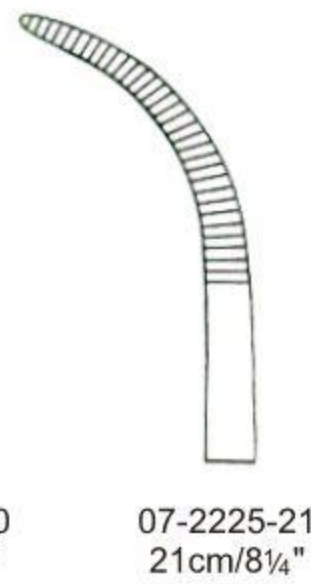
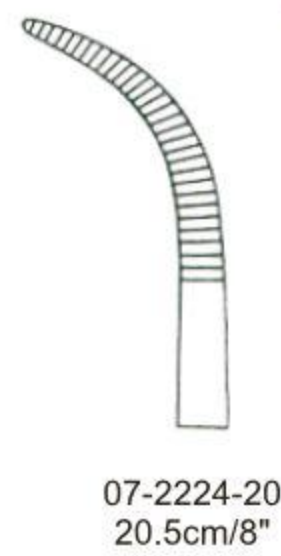
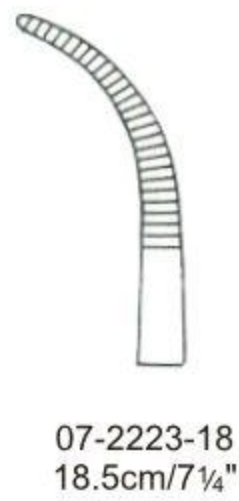
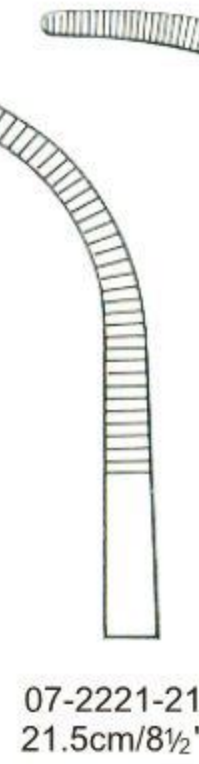
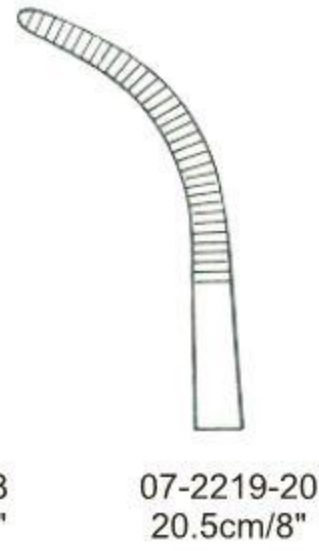
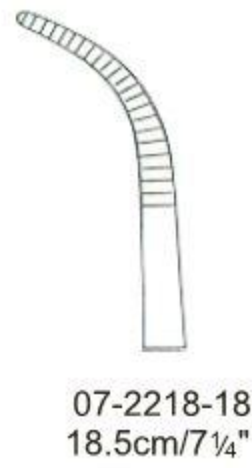



Overholt-Geissendorfer
21cm/8¼"
27cm/10½"

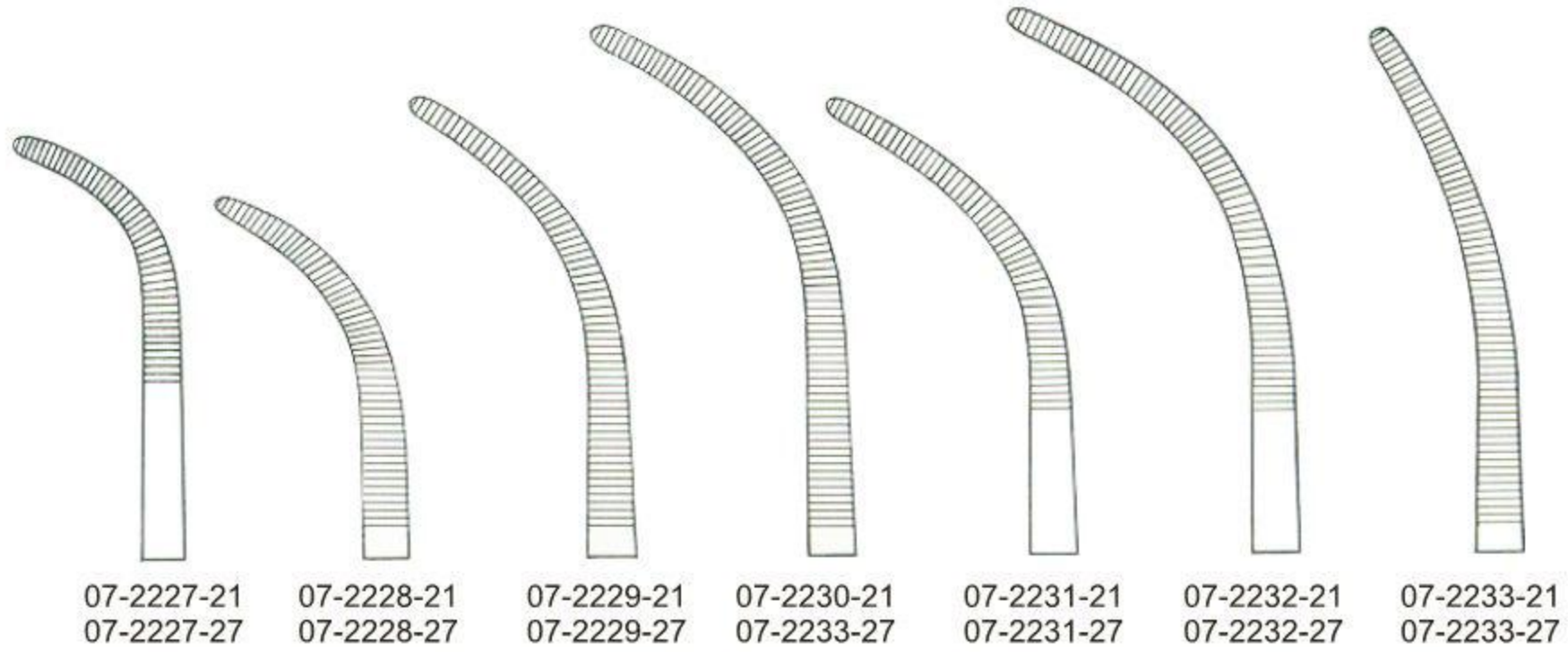

07-2227-21 07-2228-21 07-2229-21 07-2230-21 07-2231-21 07-2232-21 07-2233-21
07-2227-27 07-2228-27 07-2229-27 07-2233-27 07-2231-27 07-2232-27 07-2233-27



Overholt-Mixter
07-2234-21
21cm/8¼"



Heiss
20cm/8"

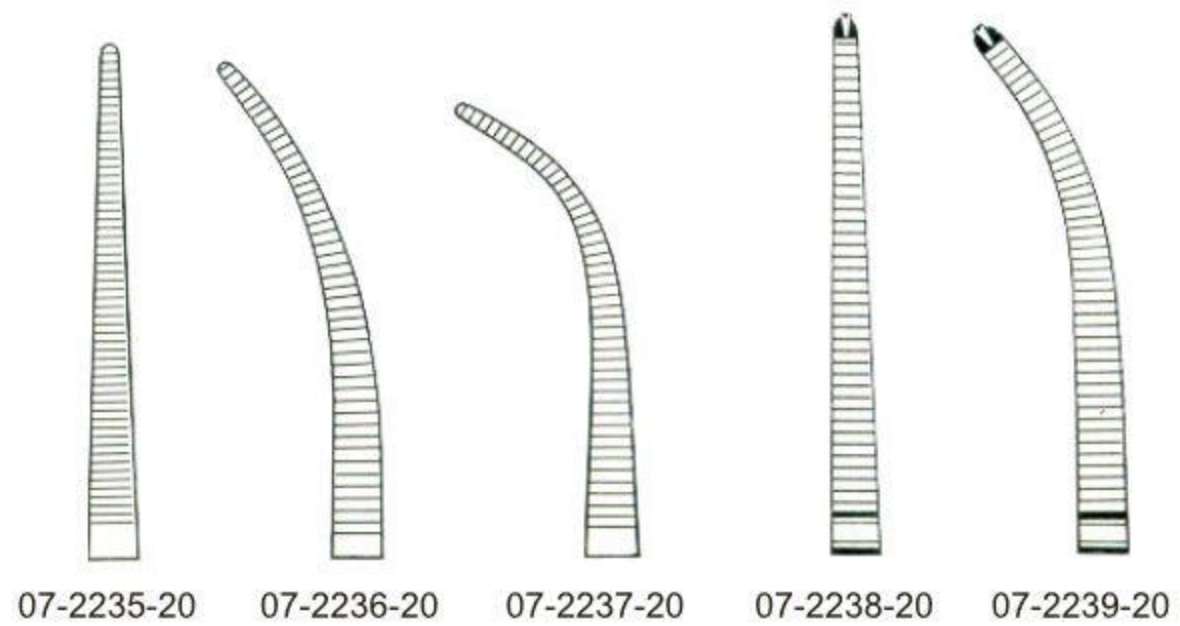

07-2235-20 07-2236-20 07-2237-20 07-2238-20 07-2239-20



Meeker
 07-2240-27
 27 cm/10½"



Toennis
 21 cm/8¼"
 26 cm/10¼"

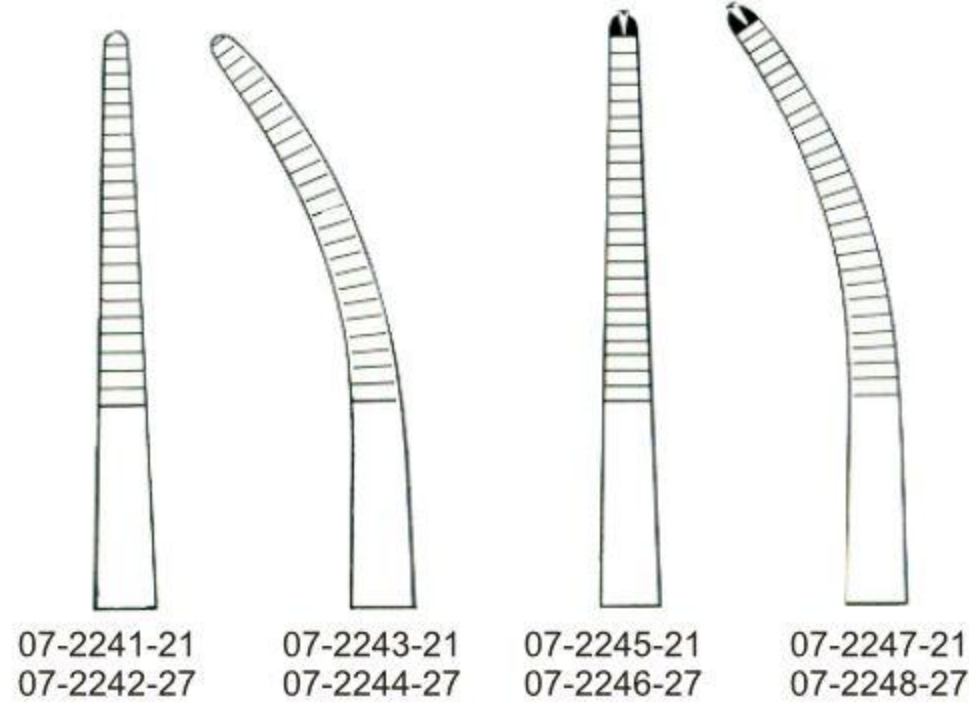

07-2241-21
 07-2242-27

07-2243-21
 07-2244-27

07-2245-21
 07-2246-27

07-2247-21
 07-2248-27



Lower
 07-2249-18
 18 cm/7"



Gemini

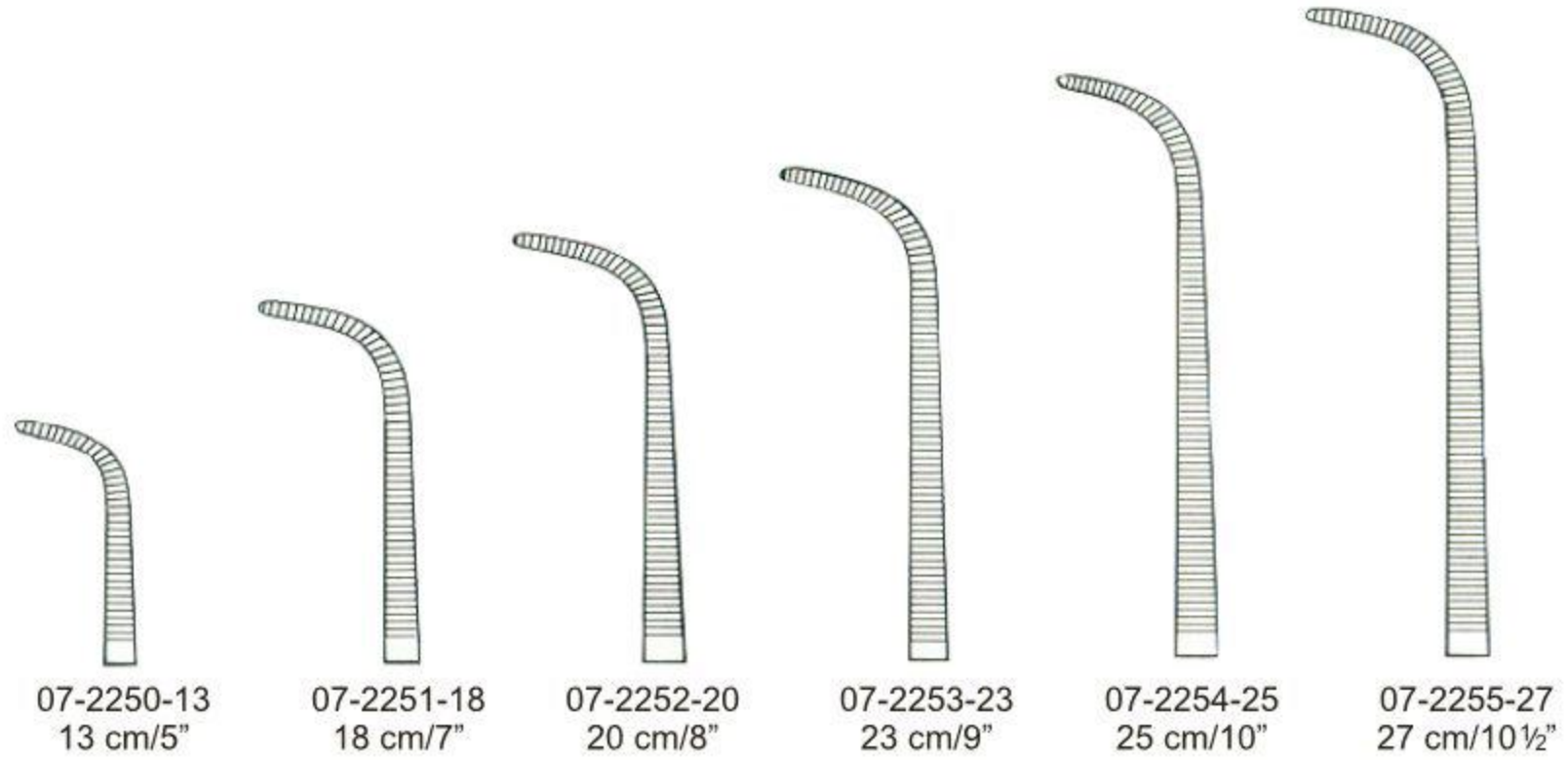

07-2250-13
 13 cm/5"

07-2251-18
 18 cm/7"

07-2252-20
 20 cm/8"

07-2253-23
 23 cm/9"

07-2254-25
 25 cm/10"

07-2255-27
 27 cm/10½"



Mini-Gemini

07-2256-18
18 cm/7"



07-2256-22
22 cm/8¾"



07-2256-25
25 cm/10"

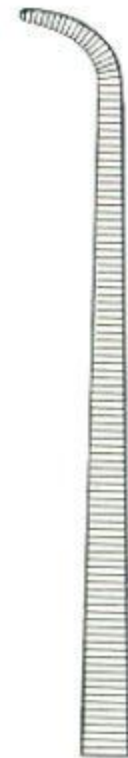

07-2256-28
28 cm/11"

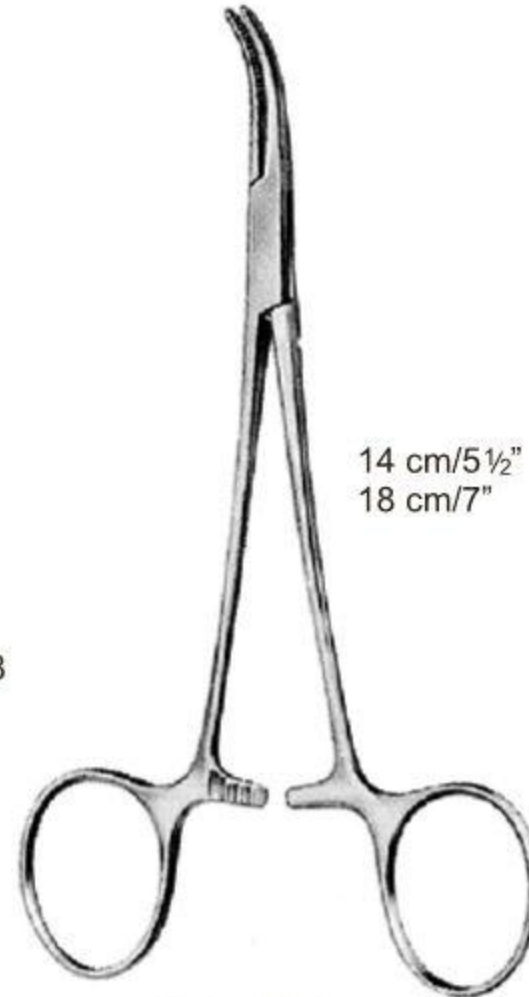

Baby-Mixer

14 cm/5½"
18 cm/7"



07-2257-14
07-2257-18



07-2258-14
07-2258-18



Mixer

07-2259-15 15 cm/6"
07-2259-19 19 cm/7½"



Mixer-O'Shaugnessy

07-2260-15 15.5 cm/6"
07-2260-19 19.0 cm/7½"

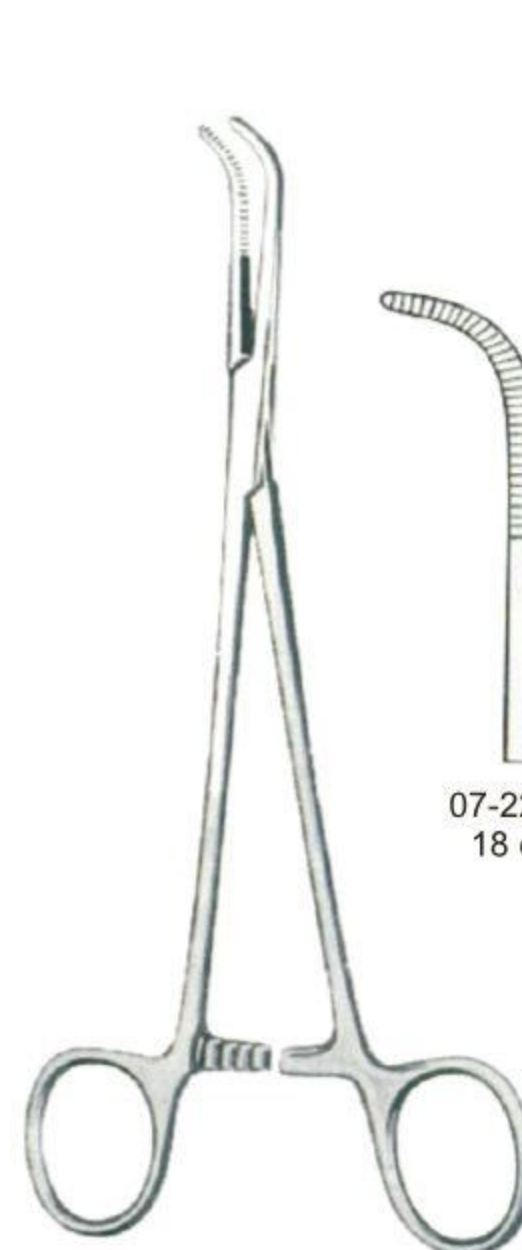

Mixer-Slim

07-2261-18
18 cm/7"

07-2261-23
23 cm/9"



07-2262-22
 22 cm/8¾"

Mixer



07-2262-25
 25 cm/10"

07-2262-28
 28 cm/11"



Mixer
 07-2263-22
 22 cm/8¾"



Wickstroem
 07-2264-20
 20 cm/8"



Finocchietto
 07-2265-24
 24 cm/9½"



Mc Quigg-Mixer
 07-2266-22
 22 cm/8¾"



Lawrence
07-2267-27
27.5 cm/10¾"



Lahey (Sweet)



07-2268-19
19 cm/7½"



07-2269-23
23 cm/9"

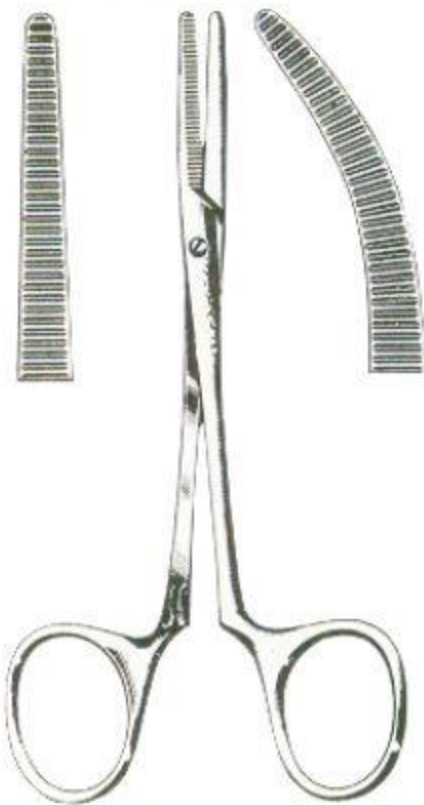

Spencer-Wells

- | | | |
|------------|----------|------------|
| 07-2270-13 | 13 cm/5" | 07-2271-13 |
| 07-2270-15 | 15 cm/6" | 07-2271-15 |
| 07-2270-18 | 18 cm/7" | 07-2271-18 |
| 07-2270-20 | 20 cm/8" | 07-2271-20 |
| 07-2270-23 | 23 cm/9" | 07-2271-23 |



Spencer-Wells



- | | |
|------------|------------|
| 07-2272-13 | 13 cm/5" |
| 07-2272-14 | 14 cm/5 ½" |
| 07-2272-15 | 15 cm/6" |
| 07-2272-18 | 18 cm/7" |
| 07-2272-20 | 20 cm/8" |
| 07-2272-23 | 23 cm/9" |



- | |
|------------|
| 07-2273-13 |
| 07-2273-14 |
| 07-2273-15 |
| 07-2273-18 |
| 07-2273-20 |
| 07-2273-23 |

Artery Forceps ●— EN
 Arterienklemmen ●— DE
 Pinzas hemostaticas ●— ES



Rogers

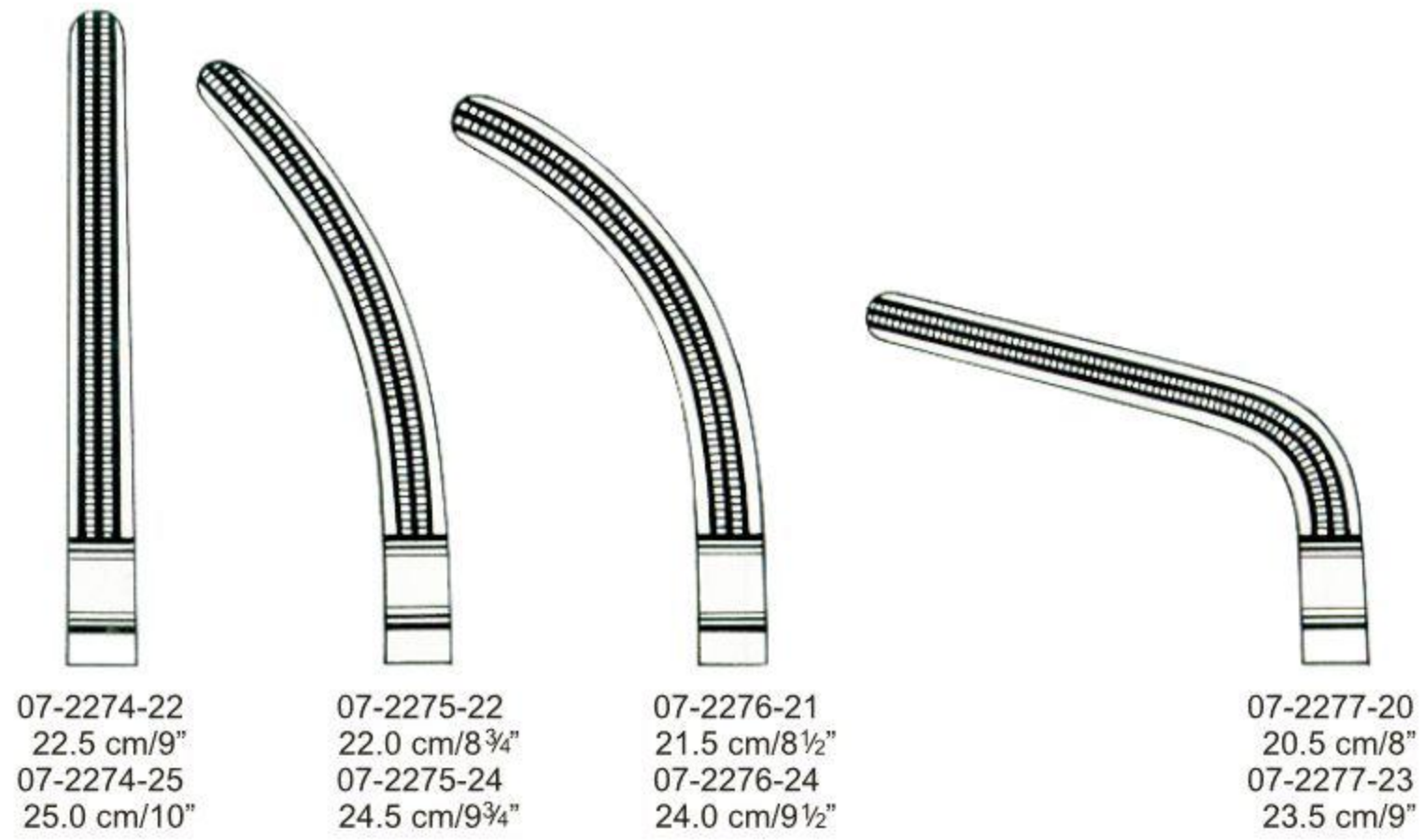

Heaney

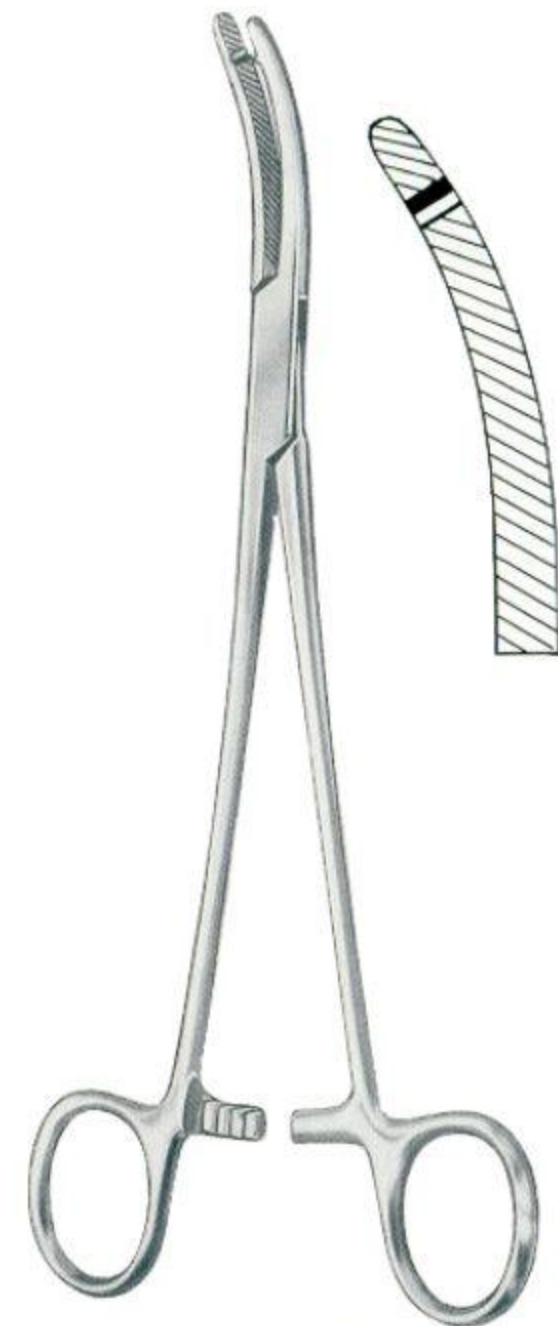
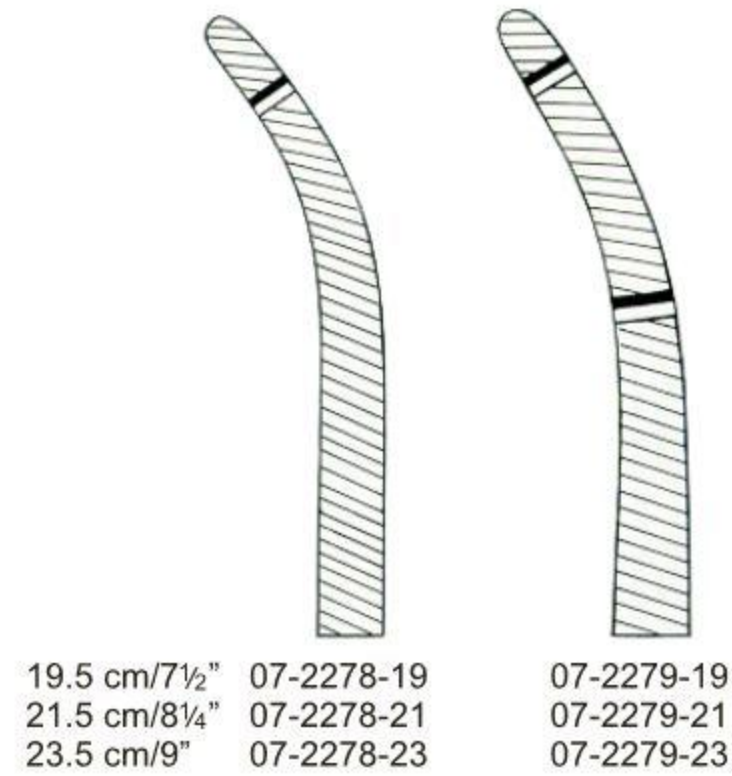

Heaney-Slim
 07-2280-21
 21 cm/8¹/₄"

EN —● Ophthalmologie. Ophthalmology, Oftalmoloia
 DE —● Keratoplastikmesser, Stanzen Meißel
 ES —● Keratoplastikmesser, Stanzen Meißel



Ballentine
07-2281-21
21cm/8¼"



Heaney-Ballentine
07-2282-21
21cm/8¼"



Tonsil Forceps



Fig. 1



Fig. 2

Negus
07-2283-19 19cm/7½" 07-2284-19



Phaneuf
21.5cm/8½"



07-2285-21



07-2286-21



Haemorrhoidal Clamps

Straight		Curved
16cm/6¼"	07-2287-16	07-2288-16
20cm/8"	07-2287-20	07-2288-20

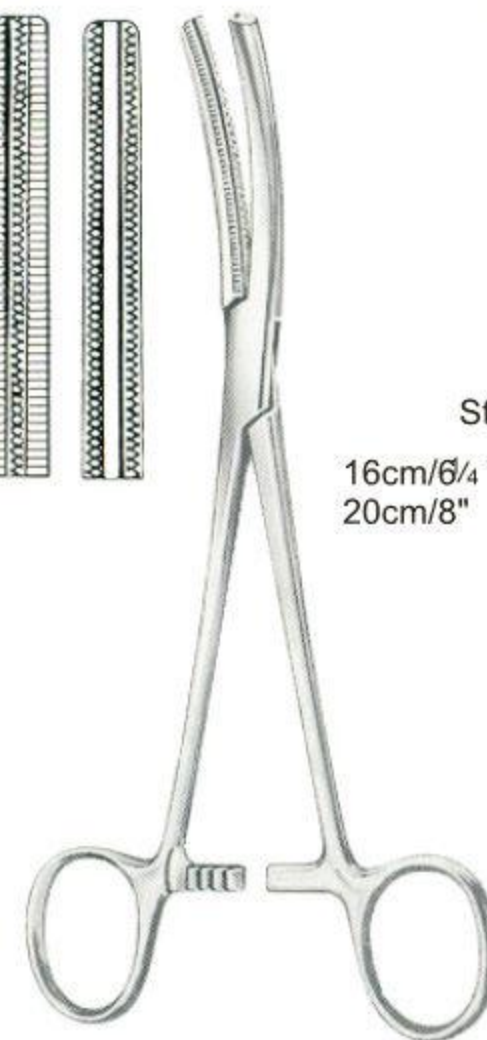

Fergusson

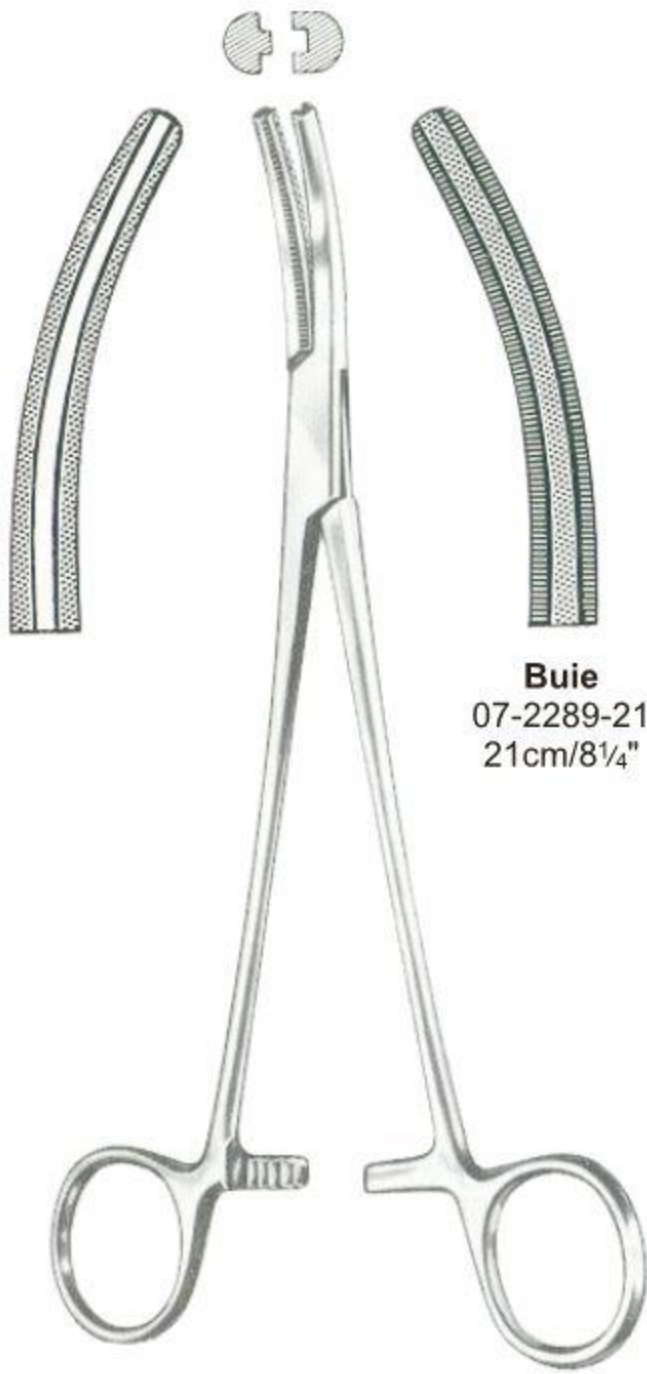

Buie
 07-2289-21
 21cm/8¼"

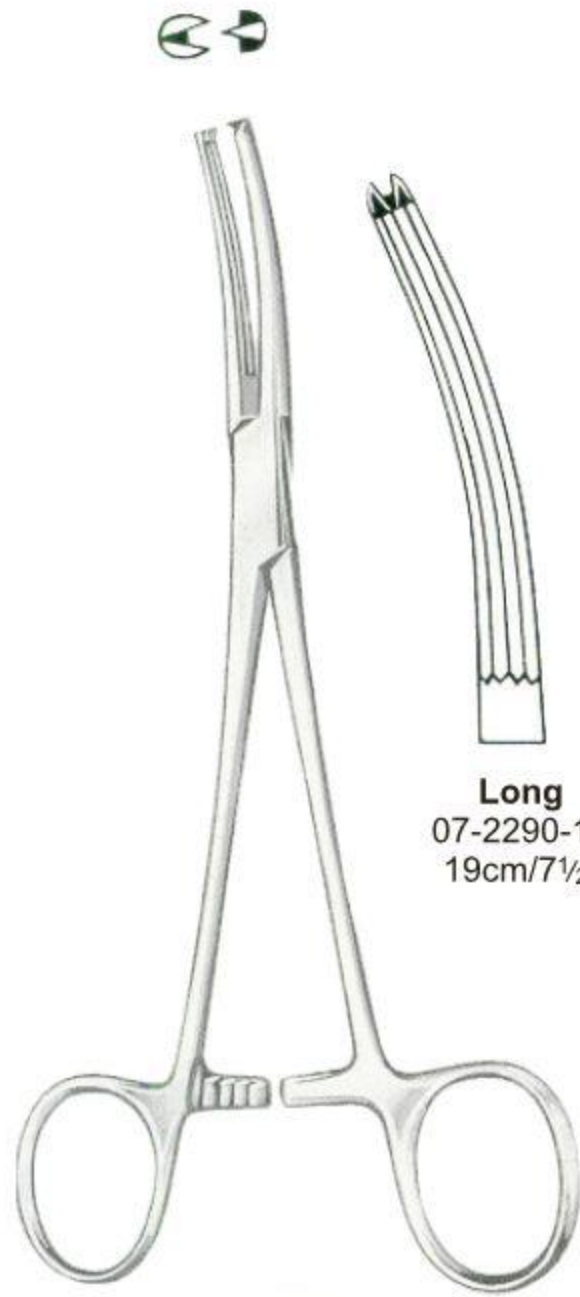

Long
 07-2290-19
 19cm/7½"



Garland
 07-2291-21
 21cm/8¼"

Gall Duct Clamps

Hysterectomy Forceps

Pressure Clamps

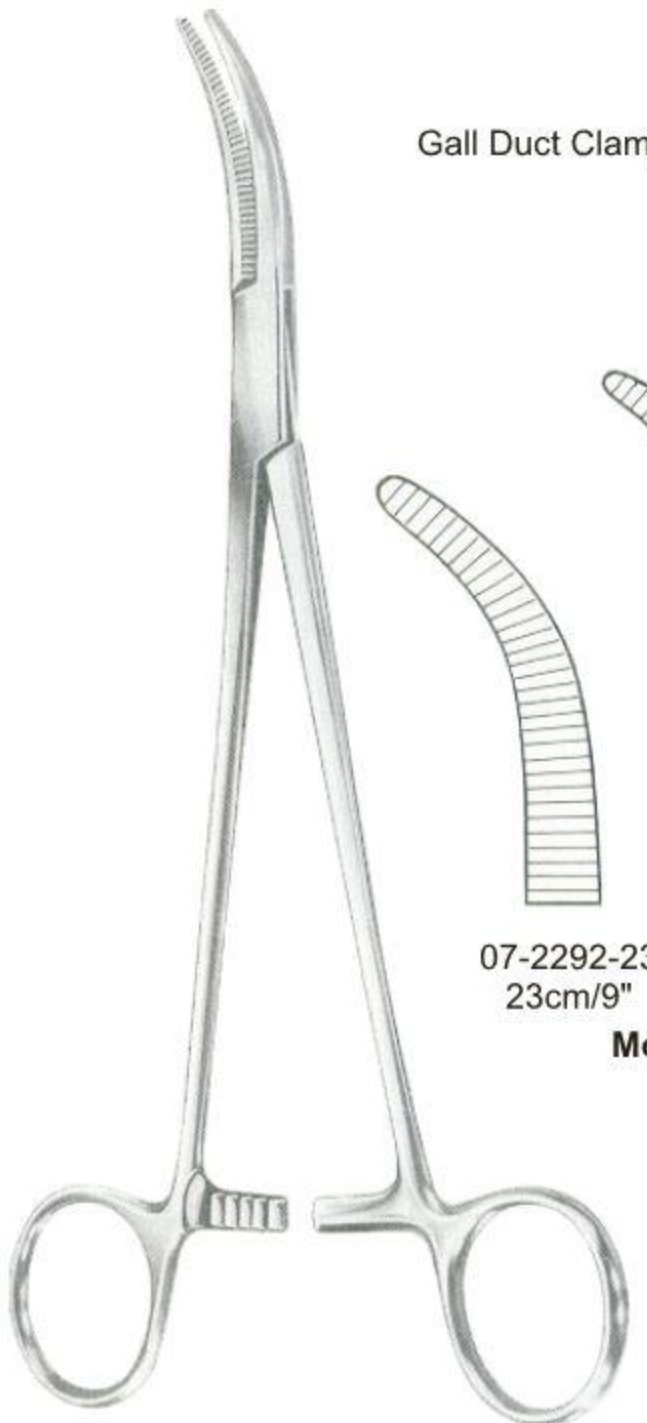

07-2292-23
 23cm/9"

07-2292-24
 24cm/9½"

Moynihan



07-2293-23

07-2294-23

Hozlbach
 23.5cm/9¼"



Zweifel
 07-2295-17
 17.5cm/7"

Scalp Flap Forceps



Martel
07-2296-14
14cm/5½"



Wertheim
07-2297-25
25cm/10"



Wertheim-Cullen
07-2298-21
21.5cm/8½"



Wertheim
07-2299-24
24cm/9½"

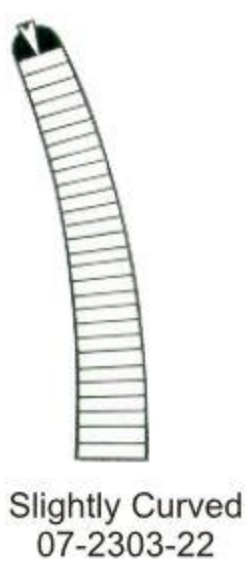
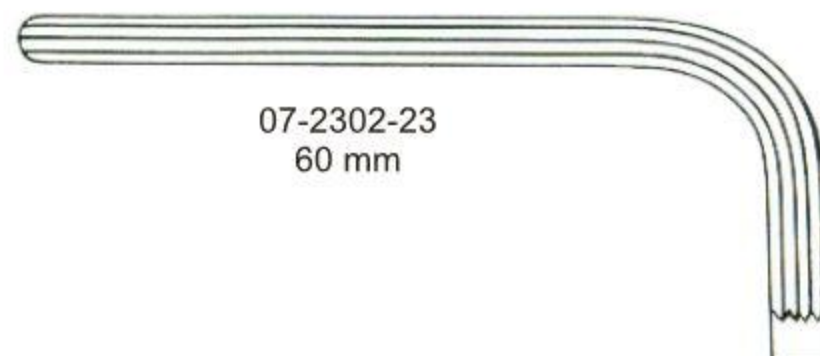
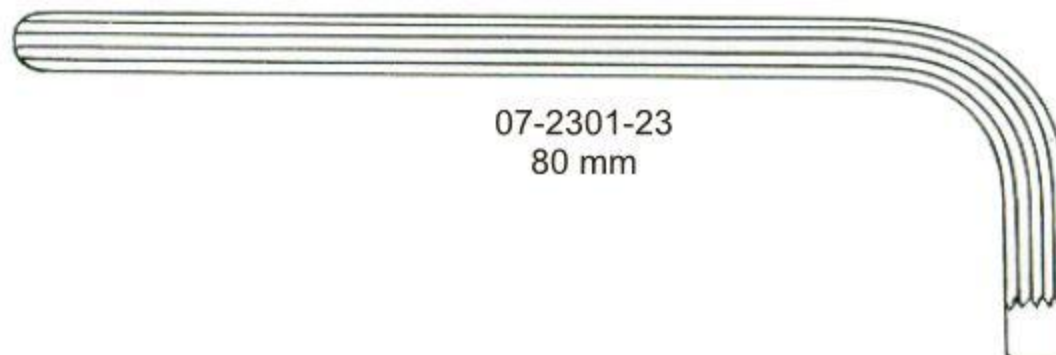
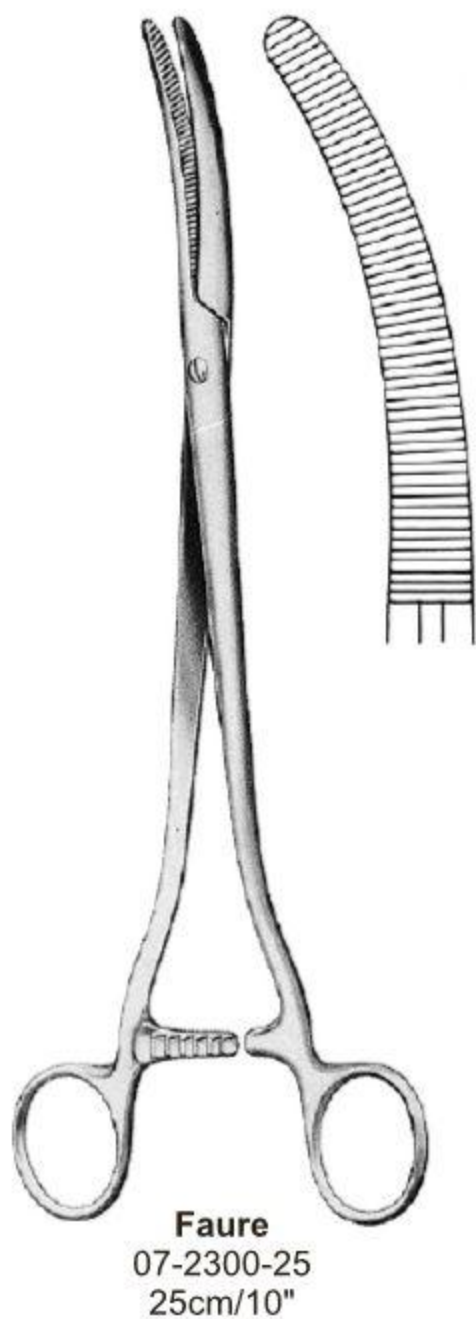



Wertheim
07-2306-18
18 cm/7"



Baby-Mikulicz
07-2307-14
14 cm/5½"

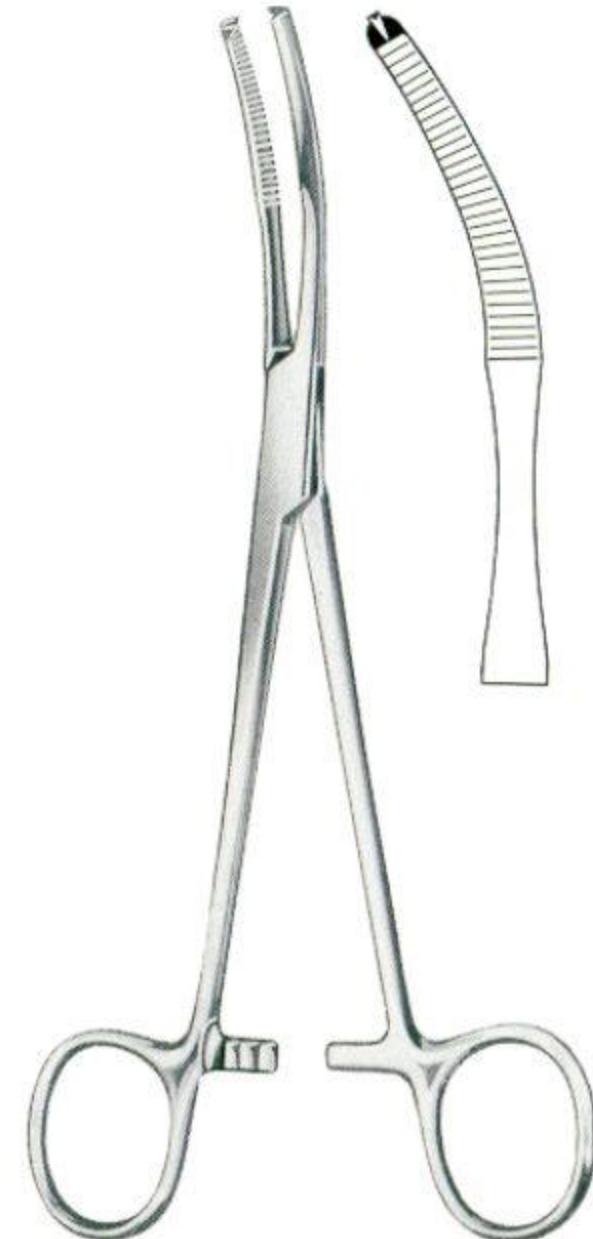

Mikulicz
07-2308-18 18cm/7"
07-2308-20 20cm/8"



Mikulicz
07-2309-20
20 cm/8"



Mikulicz
07-2310-18
18.5 cm/7 "

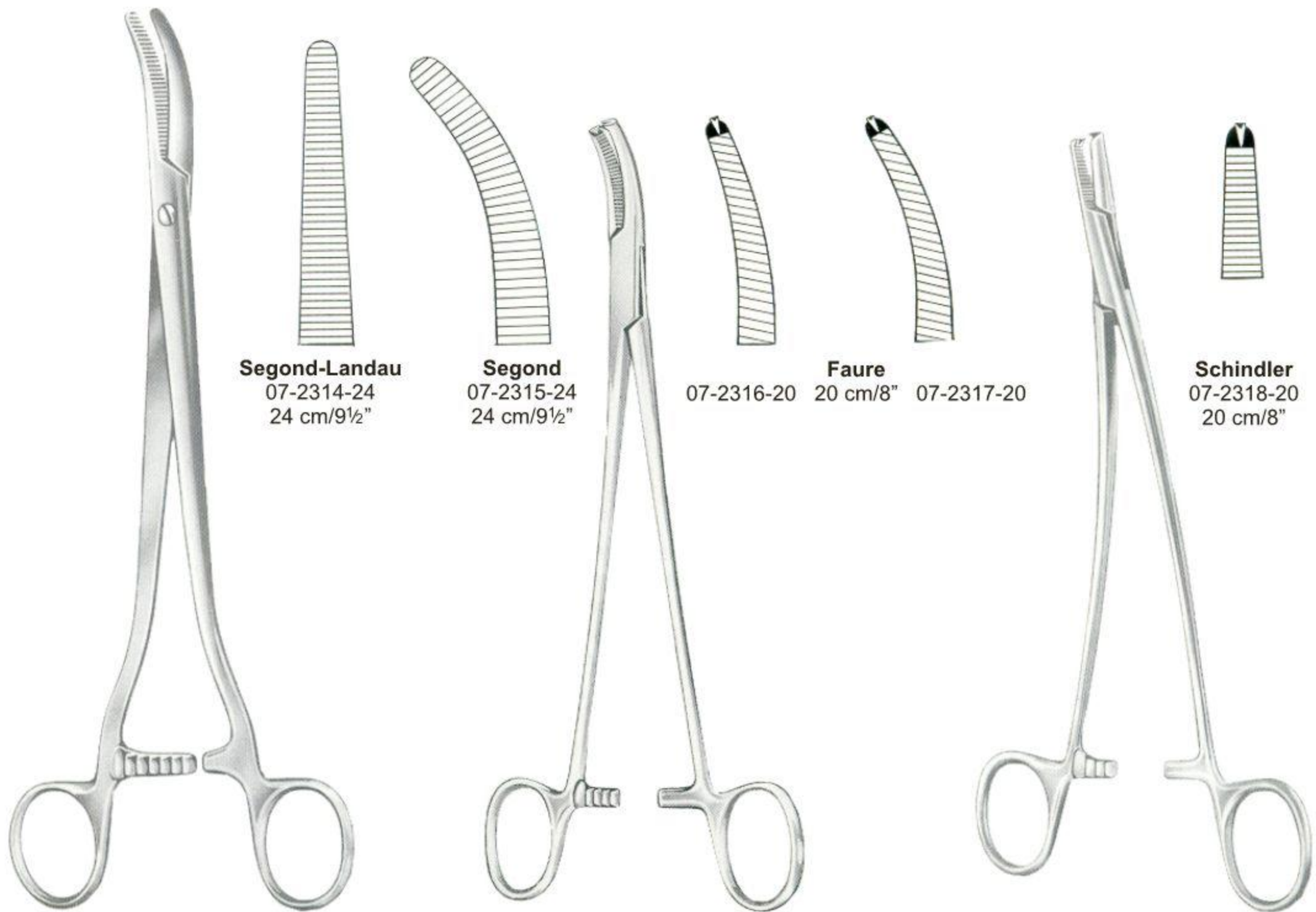
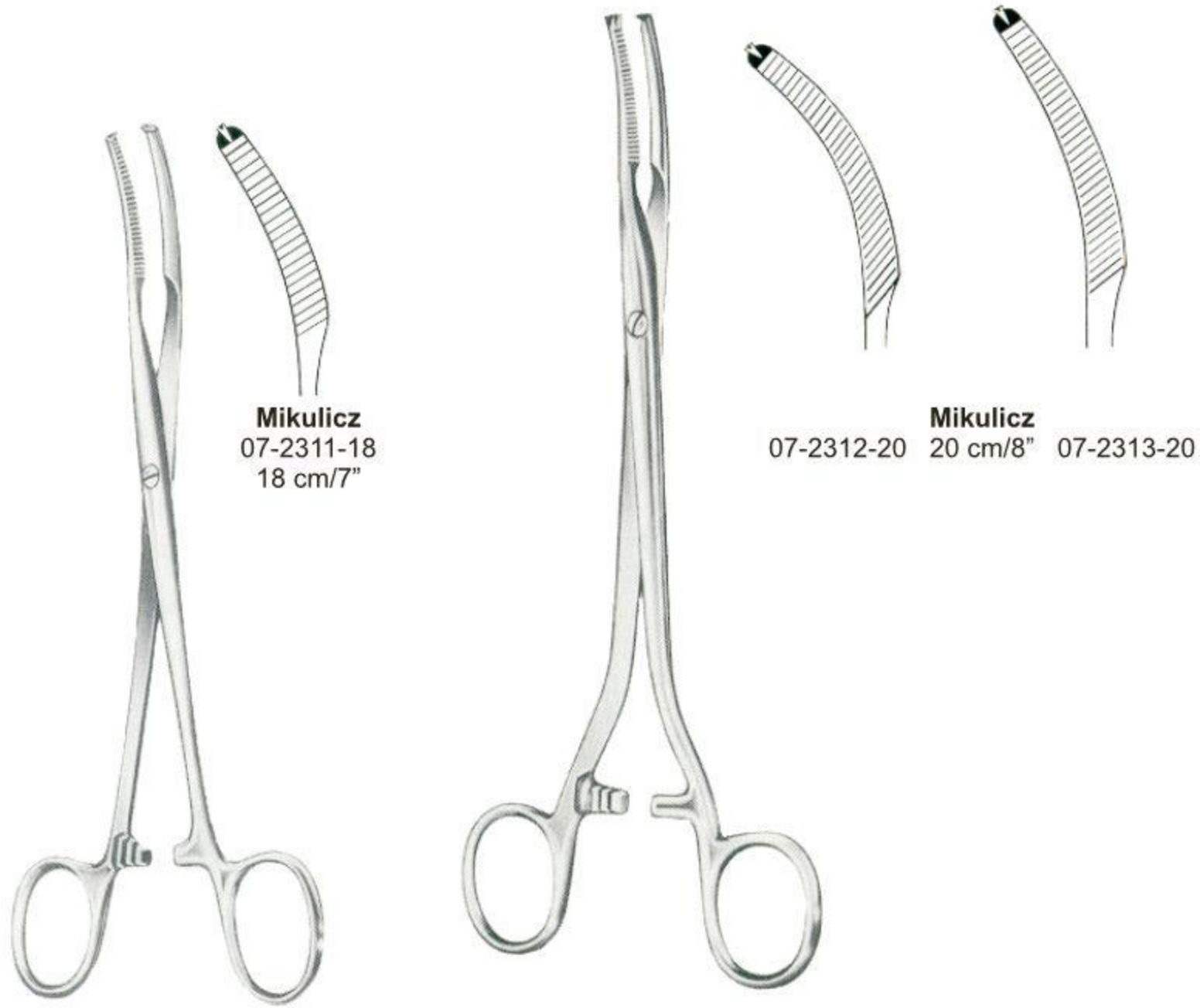



Schadel
07-2319-09 9 cm/3½"



Jones
07-2320-05 5 cm/2"
07-2320-09 9 cm/3 ½"



Engl-Modell
07-2321-09 9 cm/3½"



Backhaus
07-2322-09 9 cm/3 ½"
07-2322-11 11 cm/4 ½"
07-2322-13 13 cm/5"
07-2322-15 15 cm/6"

With clip for Tubing or Cable



07-2323-11 11 cm/4 ½"
07-2323-13 13 cm/5"



Peers-Bertram
07-2324-14 14.5 cm/5¾"



Tohoku
07-2325-10 10 cm/4"
07-2325-13 13 cm/5"

Artery Forceps ●— EN
 Arterienklemmen ●— DE
 Pinzas hemostaticas ●— ES



Roder
 07-2326-13 13 cm/5"
 07-2326-15 15 cm/6"



Lorna
 07-2327-10 10 cm/4"
 07-2327-13 13 cm/5"



Bernhard
 07-2328-16 16.5 cm/6 1/2"



Lane
 07-2329-20
 20 cm/8"



Doyen
 07-2330-18
 18 cm/7"

Artery Forceps ● EN
 Arterienklemmen ● DE
 Pinzas hemostaticas ● ES



07-2331-14 14 cm/5 1/2"
 07-2331-15 15 cm/6"
 07-2331-18 18 cm/7"
 07-2331-20 20 cm/8"



07-2332-14
 14.5 cm/5 3/4"

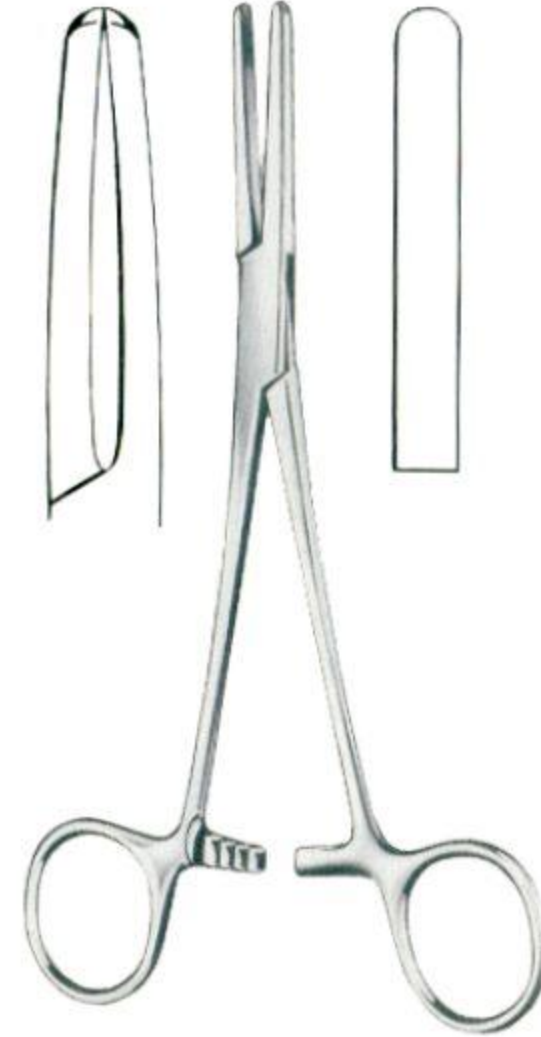

07-2333-16 16.5 cm/6 1/2"
 07-2333-18 18.0 cm/7"



07-2334-15 15 cm/6"
 07-2334-18 18 cm/7"
 07-2334-20 20 cm/8"



Mohr
 07-2335-50 50 mm
 07-2335-60 60 mm
 07-2335-70 70 mm
 07-2335-80 80 mm

Sizes
 mm
 13
 17
 20
 25
 30

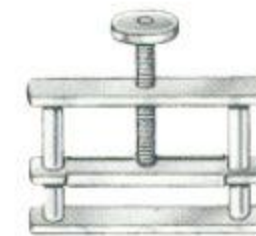

Hoffmann
 07-2336-13
 07-2336-17
 07-2336-20
 07-2336-25
 07-2336-30



Hoffmann
 07-2337-13
 07-2337-17
 07-2337-20
 07-2337-25
 07-2337-30

- EN** Cotton Swab Forceps
- DE** Tupfer-und Kornzangen
- ES** Pinzas para tapones y curaciones

Page 141 to 144



EN —● Cotton Swab, Polypus and Dressing Forceps
 DE —● Tupferzangen, Korn-(Polypen-)Zangen
 ES —● Pinzas para tapones, Pinzas para pólipos y vendajes



Ulrich

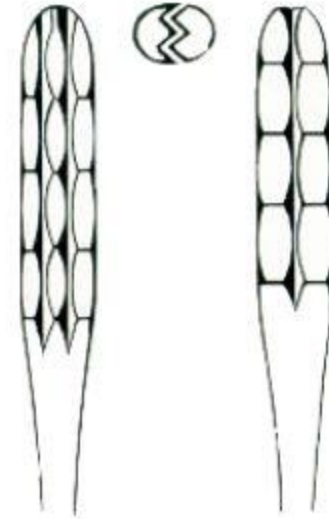

Straight

08-2401-22
 08-2401-25
 08-2401-27



Curved

22 cm/8³/₄"
 25 cm/10"
 27 cm/10¹/₂"

08-2402-22
 08-2402-25
 08-2402-27



Lister

08-2403-13	13 cm/5"	08-2404-13
08-2403-15	15 cm/6"	08-2404-15
08-2403-18	18 cm/7"	08-2404-18



Bryant

08-2405-13
 13 cm/5"



Bryant

08-2406-13
 13 cm/5"

Cotton Swab Forceps ● EN
 Tupferzangen ● DE
 Pinzas para tapones ● ES



Gross-Maier



Straight

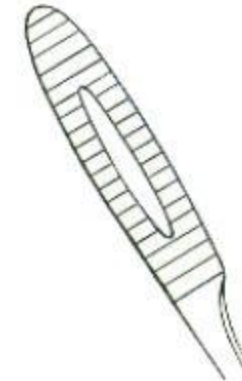

Curved

With Ratchet

08-2407-20	20 cm/8"	08-2408-20
08-2407-25	25 cm/10"	08-2408-25

Without Ratchet

08-2409-20	20 cm/8"	08-2410-20
08-2409-25	25 cm/10"	08-2410-25



Pelkmann
 25 cm/10"



08-2411-25



08-2412-25

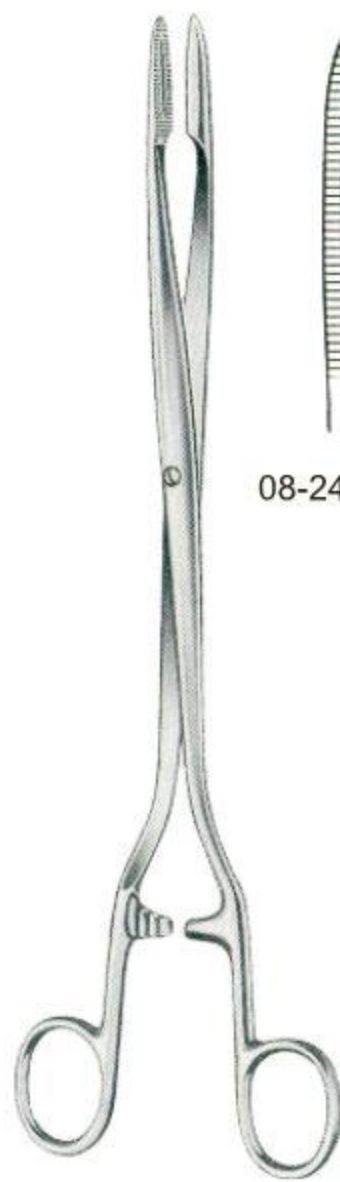

Sims-Maier
 28 cm/11"



08-2413-28



08-2414-28



Duplay
 20 cm/8"



08-2415-20



08-2416-20

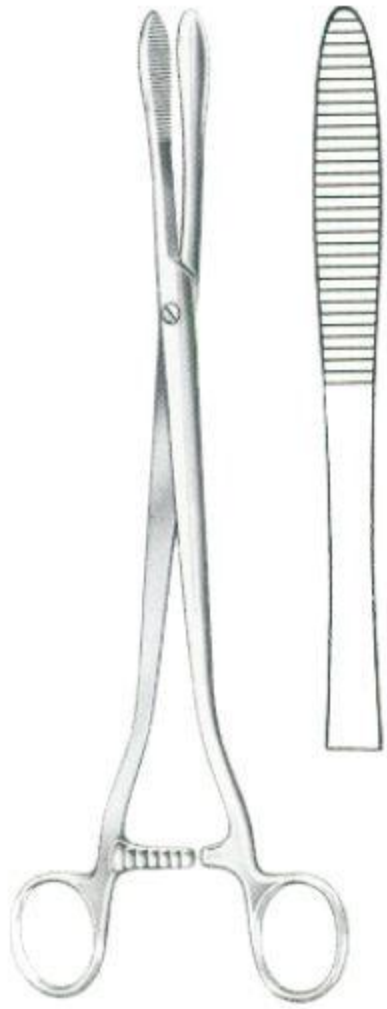

Collin
08-2417-25
25cm/10"

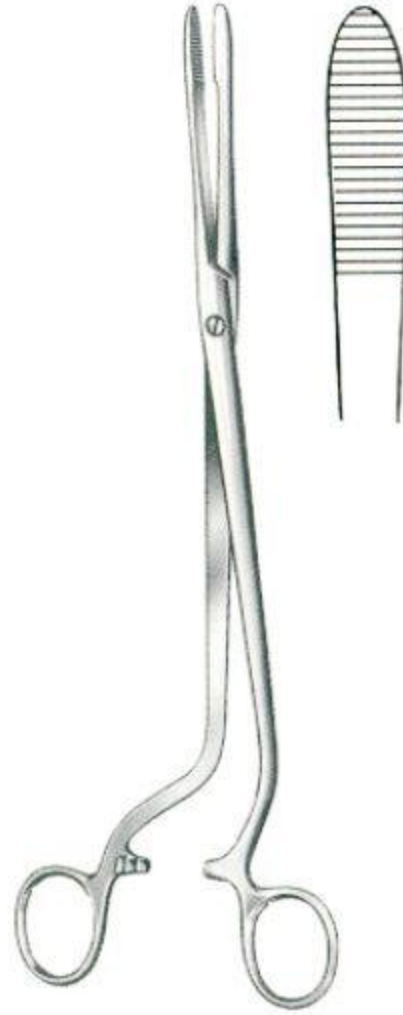

Cheron
08-2418-25
25cm/10"



Emmet
08-2419-21
21cm/8 1/4"



Bozemann
08-2420-26
26cm/10 1/4"



Bozemann
08-2421-26
26cm/10 1/4"



08-2421-26



08-2422-26

Smooth

Polypus, Tumor, Cotton Swab Forceps ● EN
 Tupferzangen, Polypen-, Tumor-, Schwammzangen ● DE
 Pinzas para pólipos, tumores y esponjas ● ES

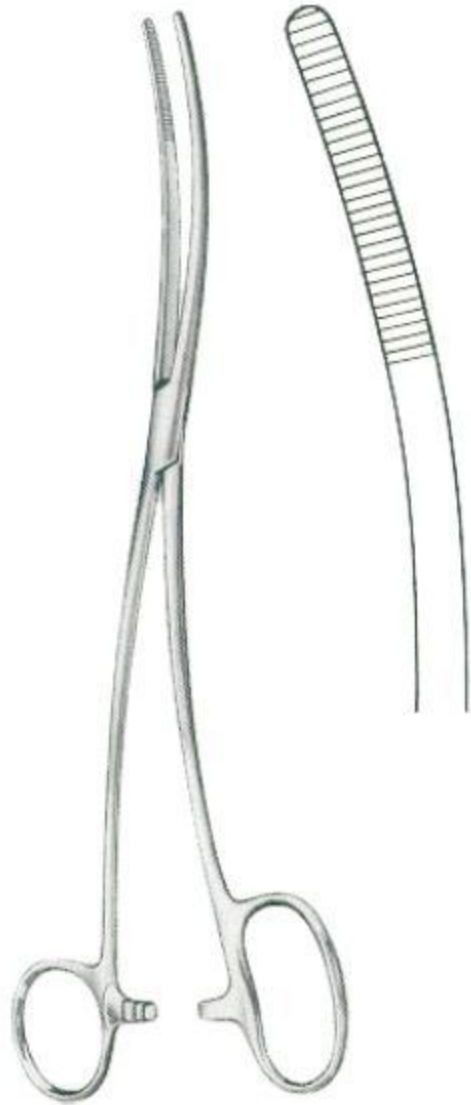

Bozemann-Douglas
08-2423-26
26cm/10¼"

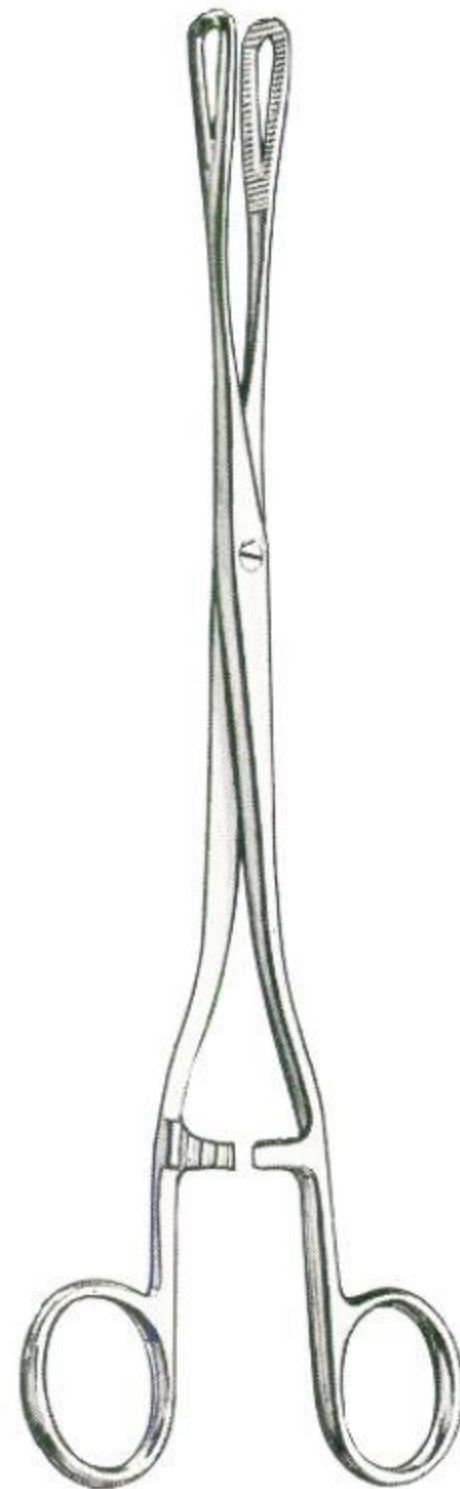

Rampley
08-2424-18 18cm/7"
08-2424-24 24cm/9 ½"



Rampley
08-2425-18 18cm/7"
08-2425-24 24cm/9 ½"



Foerster

18 cm/7"
20 cm/8"
24 cm/9½"
25 cm/10"



08-2426-18
08-2426-20
08-2426-24
08-2426-25

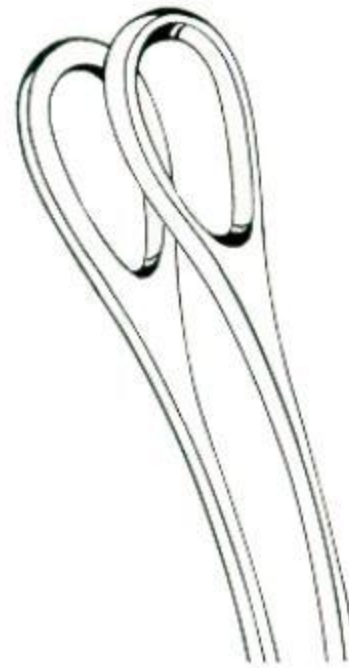

08-2427-18
08-2427-20
08-2427-24
08-2427-25



08-2428-18
08-2428-20
08-2428-24
08-2428-25

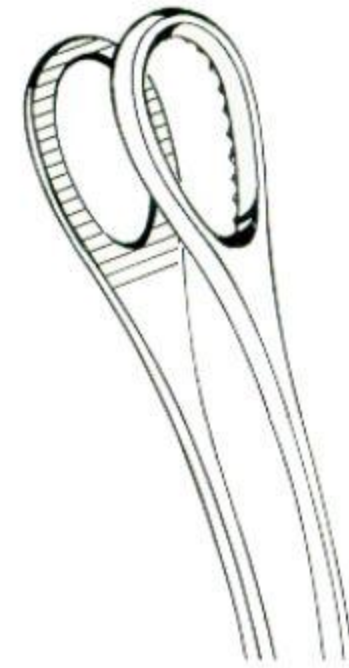

08-2429-18
08-2429-20
08-2429-24
08-2429-25

EN Suture

DE Naht

ES Sutura

Page 145 to 175





Derf
09-2501-12 12.0cm



Derf
09-2502-12 12.5cm



Collier
09-2503-12 12.5cm

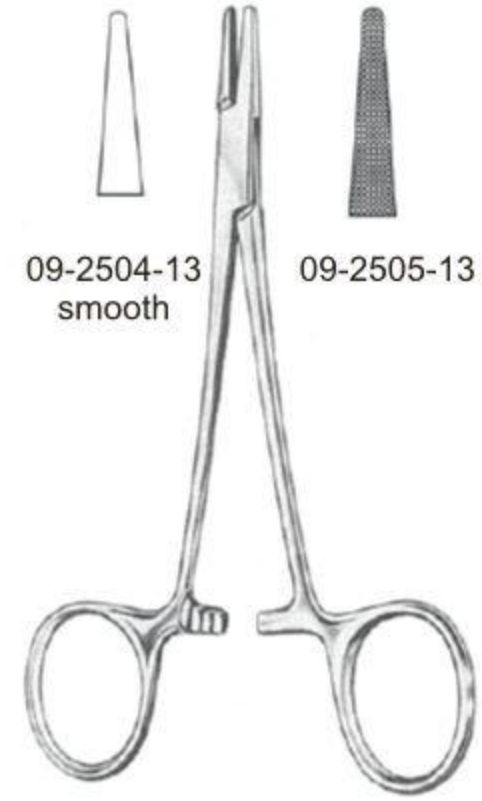

Webster
13.0cm

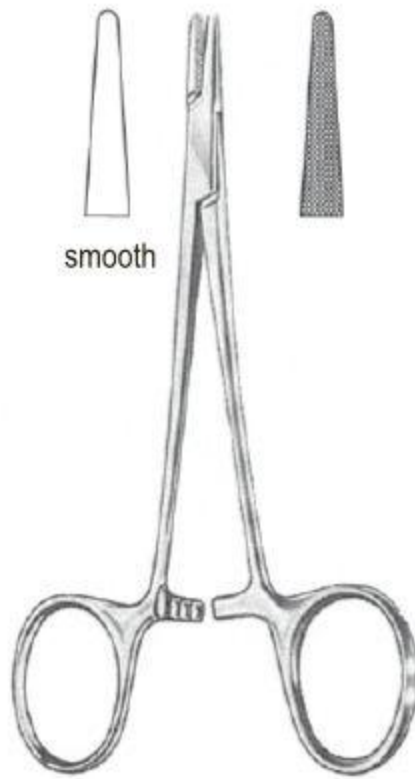

Halsey
09-2506-13 13.0cm 09-2507-13

smooth jaws with special groove



Neivert
09-2508-13 13.0cm



Hegar-Baumgartner
09-2509-12 12.5cm
09-2509-14 14.0cm



Brown
09-2510-13 13.0cm
09-2510-18 18.0cm

Needle Holders ●— EN
 Nadelhalter ●— DE
 Porta-agujas ●— ES



Mayo-Hegar

09-2511-14	14.0cm	09-2512-14
09-2511-15	15.0cm	09-2512-15
09-2511-16	16.0cm	09-2512-16
09-2511-18	18.0cm	09-2512-18
09-2511-20	20.0cm	09-2512-20
09-2511-22	22.0cm	09-2512-22
09-2511-24	24.0cm	09-2512-24
09-2511-26	26.0cm	09-2512-26
09-2511-28	28.0cm	09-2512-28
09-2511-30	30.0cm	09-2512-30



delicate pattern

Mayo-Hegar

09-2513-16	16.0cm
09-2513-18	18.0cm
09-2513-20	20.0cm



Crile-Murray

09-2514-15	15.0cm
------------	--------



Crile-Wood

09-2515-15	15.0cm
09-2515-18	18.0cm
09-2515-20	20.0cm



Hegar

09-2516-20	20.0cm	09-2517-20
09-2516-24	24.0cm	09-2517-24

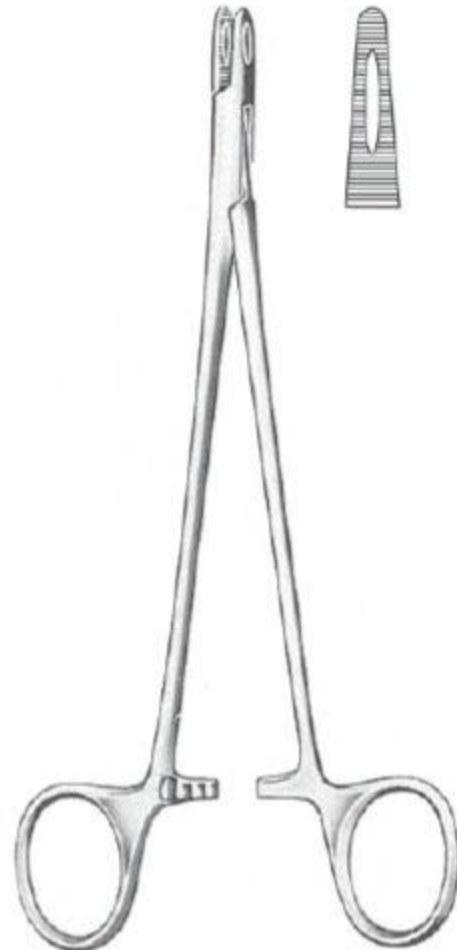

Adson

09-2518-18	18.0cm
------------	--------



Heaney

09-2519-21	21.0cm
------------	--------



Metzenbaum

09-2520-18	18.0cm
------------	--------

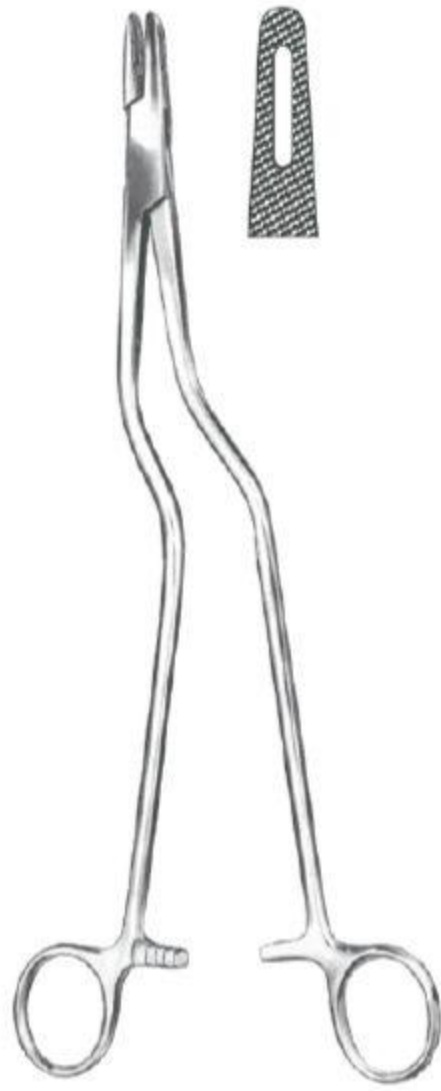

Masson-Luethy
09-2521-26 26.0cm



Sarot
09-2522-18 18.0cm
09-2522-26 26.0cm

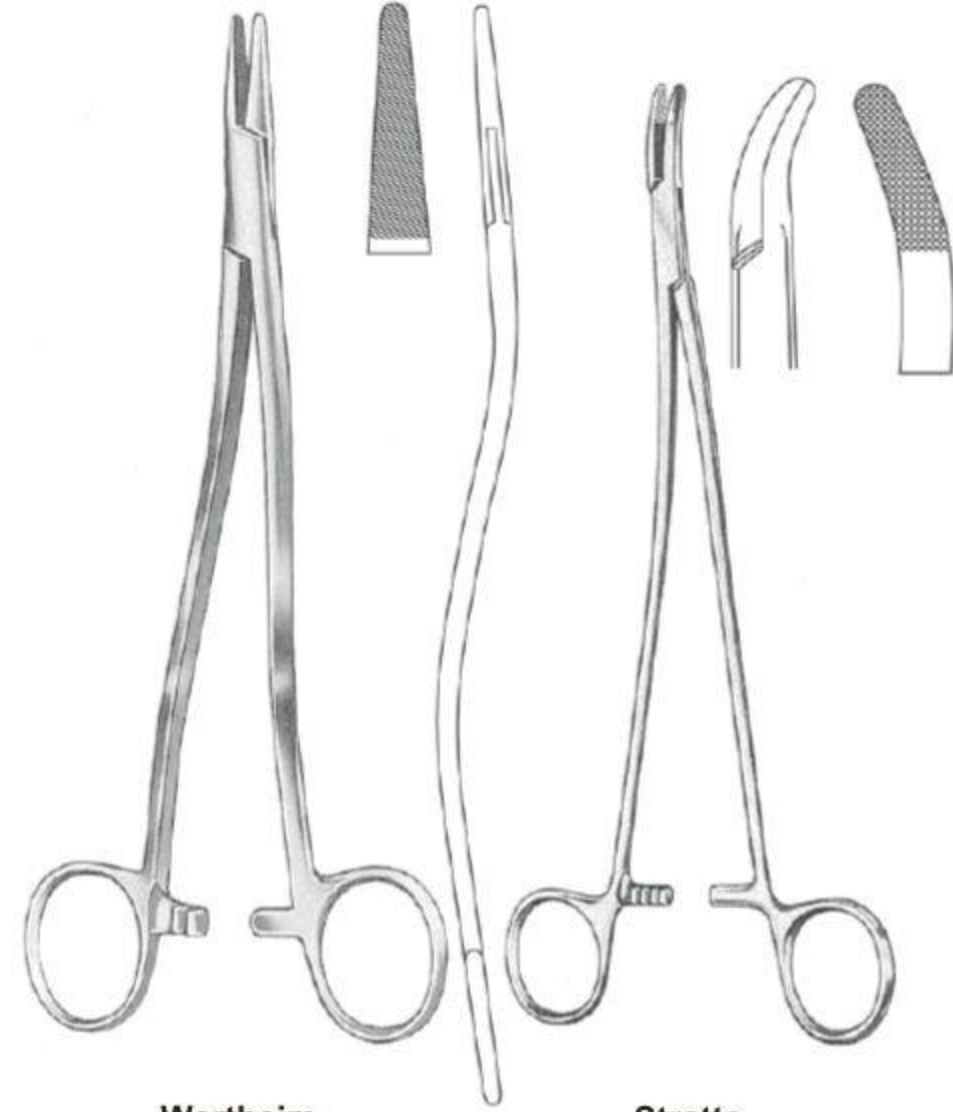

Wertheim
09-2523-20 20.0cm
09-2523-24 24.0cm

Stratte
09-2524-23 23.0cm



Bruce-Clarke
09-2525-12 12.5cm

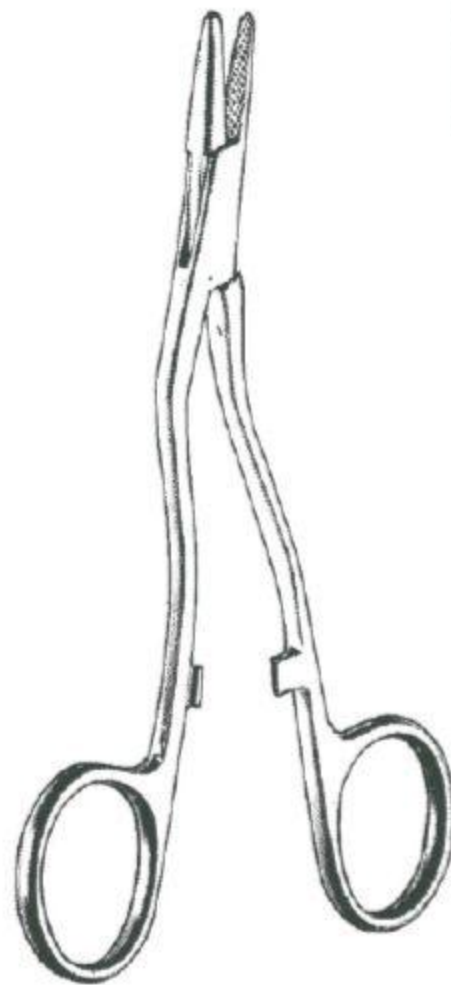

Kilner
09-2526-13 13.5cm
09-2526-16 16.5cm



Thomson-Walker
09-2527-20 20.0cm

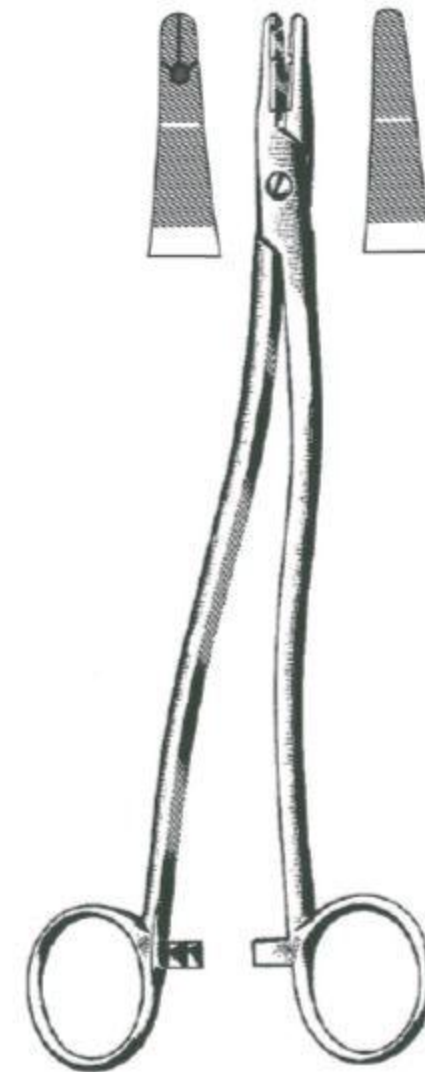

Bozemann
09-2528-20 20.0cm
09-2528-24 24.0cm

Needle Holders ●— EN
 Nadelhalter ●— DE
 Porta-agujas ●— ES



Johnson
 09-2529-27 27.0cm

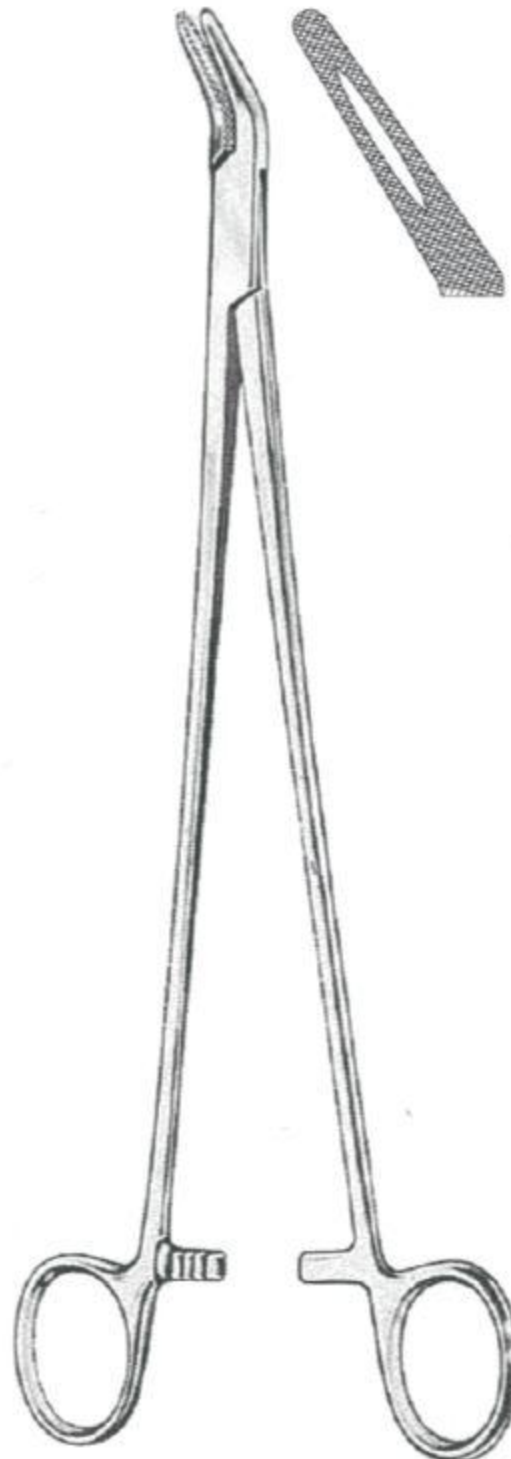

Finocchetto
 09-2530-18 18.0cm
 09-2530-20 20.0cm
 09-2530-27 27.0cm

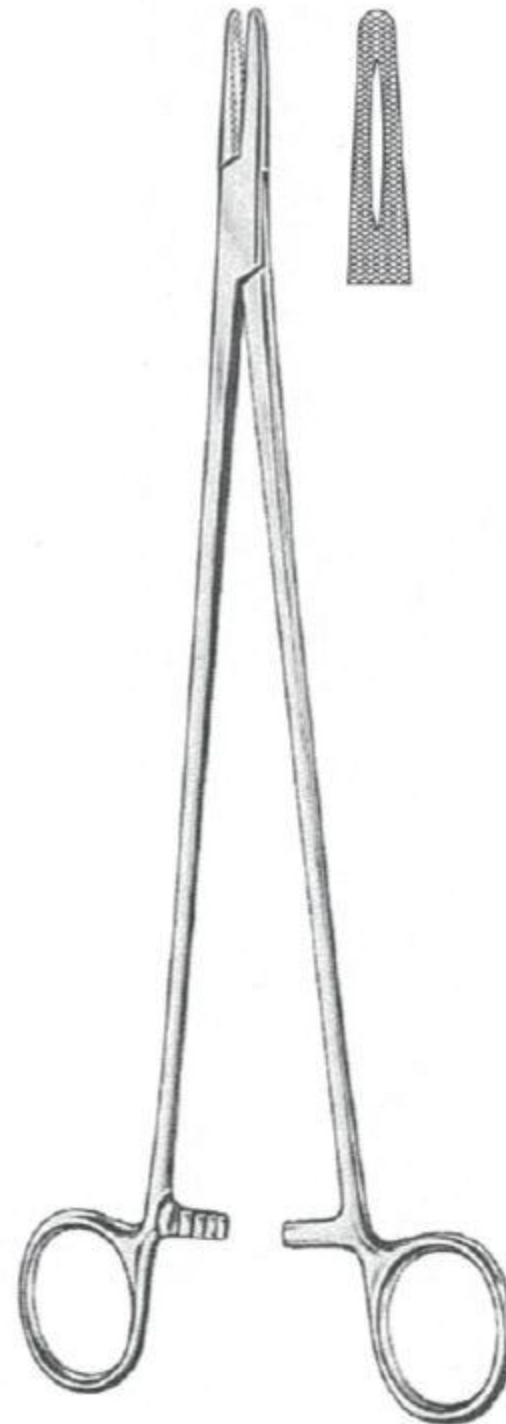

Masson
 09-2531-27 27.0cm

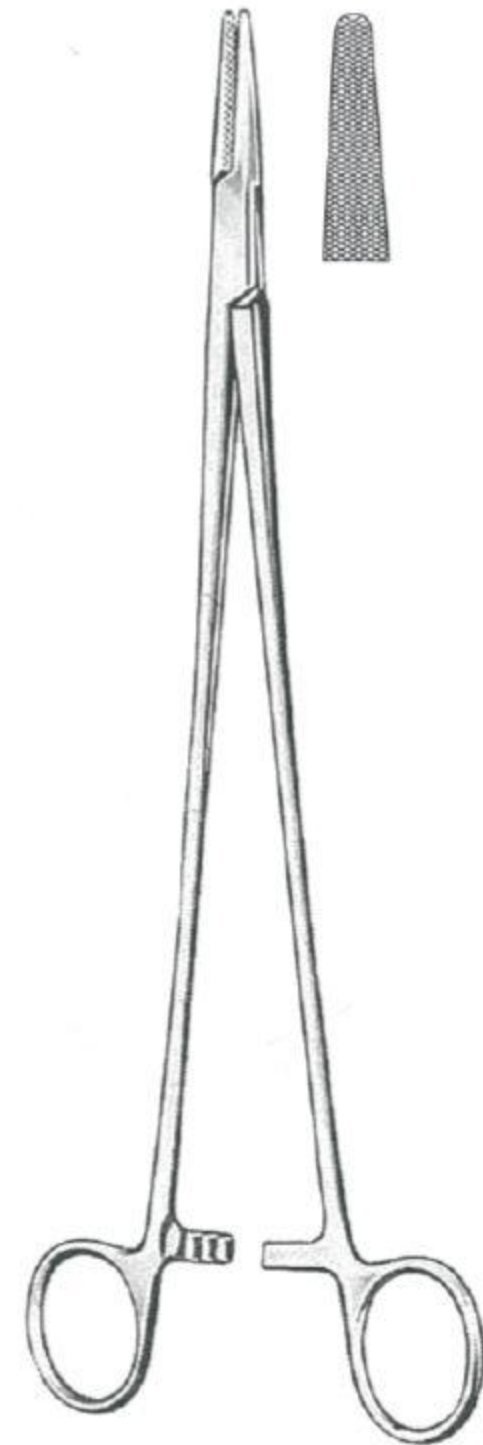

Wangenstein
 09-2532-27 27.0cm



Wangensteen
09-2533-27 27.0cm



Jamison
09-2534-23 23.5cm

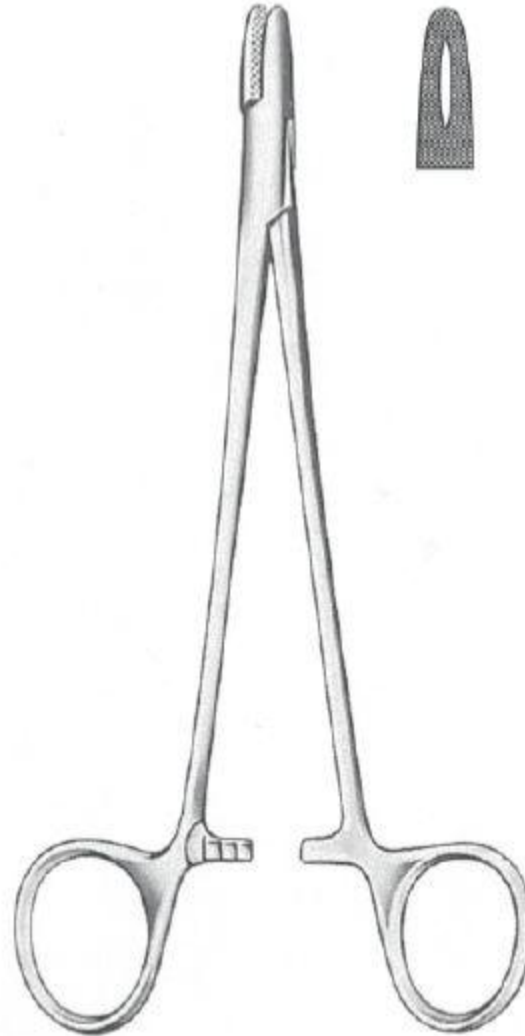

M.G.H.(mass-general-hospital)
09-2535-17 17.0cm



Gillies
09-2536-16 16.0cm (right hand)
09-2536-16 16.0cm (left hand)

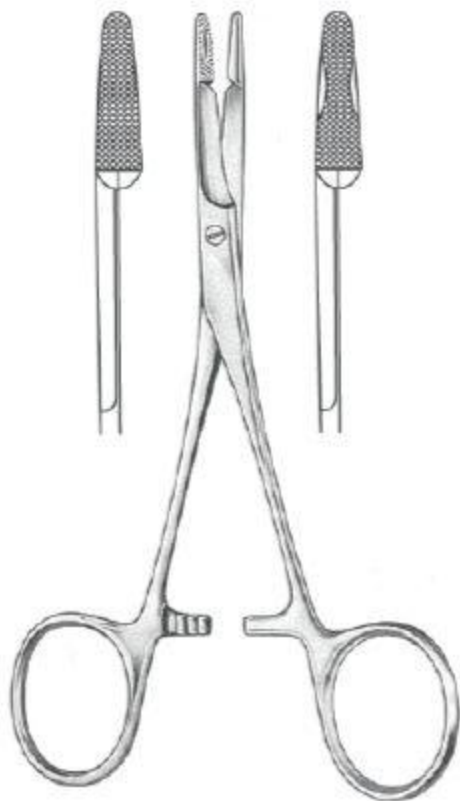

Olsen-Hegar
09-2537-14 14.0cm 09-2538-14
with blood groove

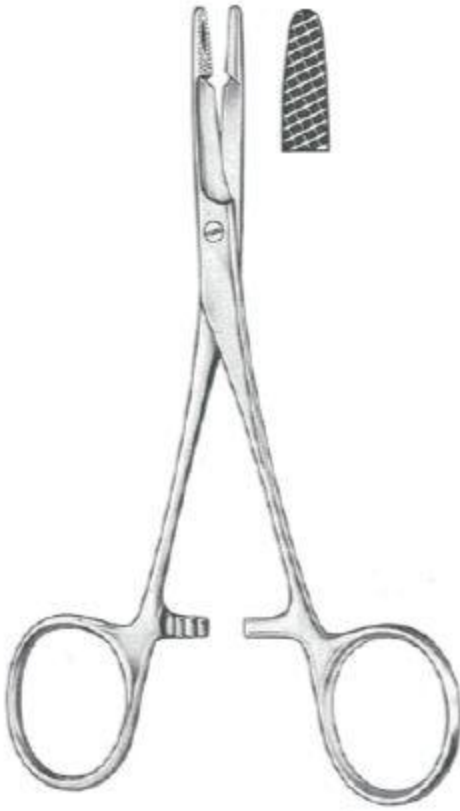

Olsen-Hegar
09-2539-17 17.0cm

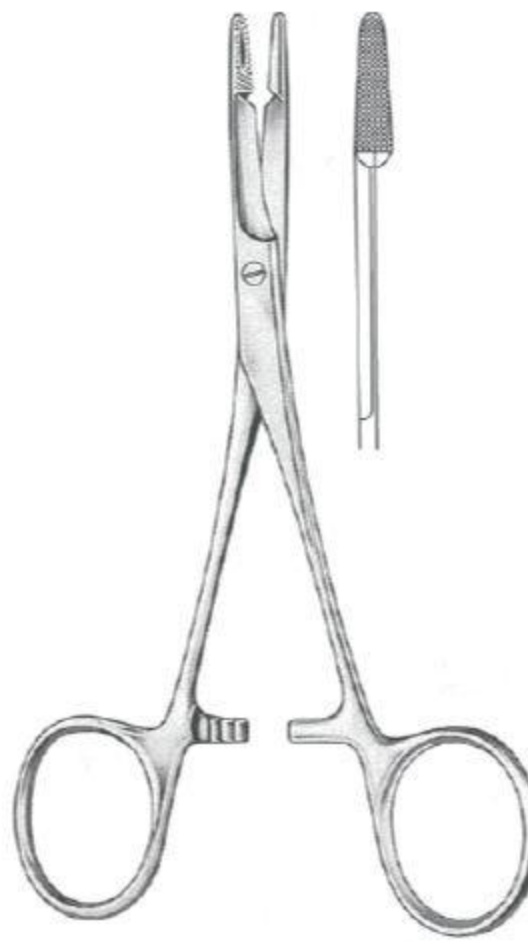

Olsen-Hegar
09-2540-17 17.0cm

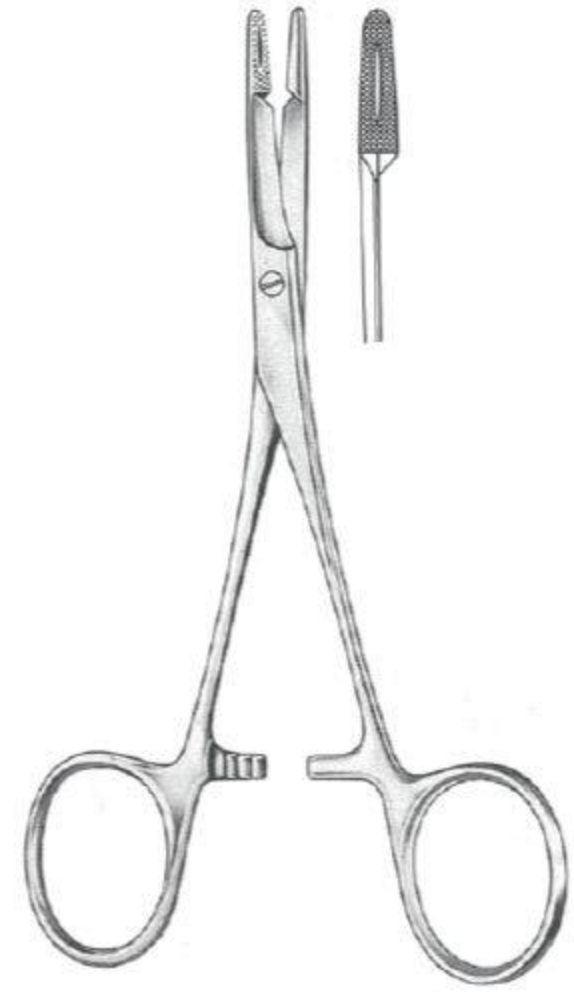

Olsen-Hegar
09-2541-14 14.0cm
09-2541-18 18.0cm

Needle Holders ●— EN
 Nadelhalter ●— DE
 Porta-agujas ●— ES



Crile
 09-2542-15 15.0cm



Toennis
 09-2543-18 18.0cm



Lichtenberg
 09-2544-20 20.0cm



Macphail
 09-2545-14 14.0cm
 09-2545-16 16.0cm
 09-2545-18 18.0cm
 09-2545-20 20.0cm



Mathieu
 09-2546-14 14.0cm 09-2547-14
 09-2546-17 17.0cm 09-2547-17
 09-2546-20 20.0cm 09-2547-20
 09-2546-24 24.0cm 09-2547-24



Mathieu
 09-2548-14 14.0cm
 09-2548-17 17.0cm



Mathieu
 09-2549-17 17.0cm
 09-2549-20 20.0cm



Straight
09-2550-14



Curved
09-2551-14

Castroviejo
14cm/5 1/2"



Straight
09-2552-14
09-2552-18



Curved
09-2553-14
09-2553-18

Castroviejo



Straight
09-2554-09



Curved
09-2554-09A

Castroviejo
9cm/3 1/2"

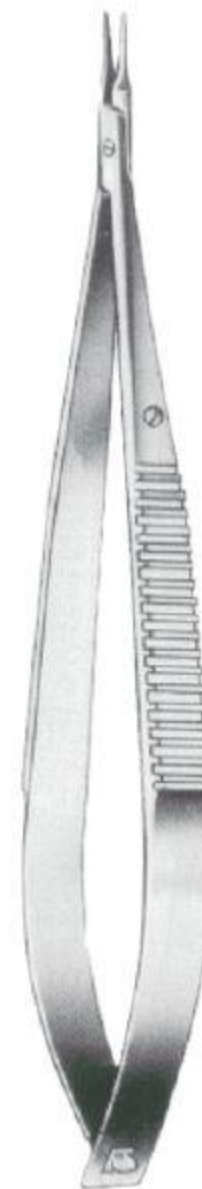

Straight
09-2555-14



Curved
09-2555-14A

Castroviejo
14cm/5 1/2"



Castroviejo
9 cm/3 1/2"

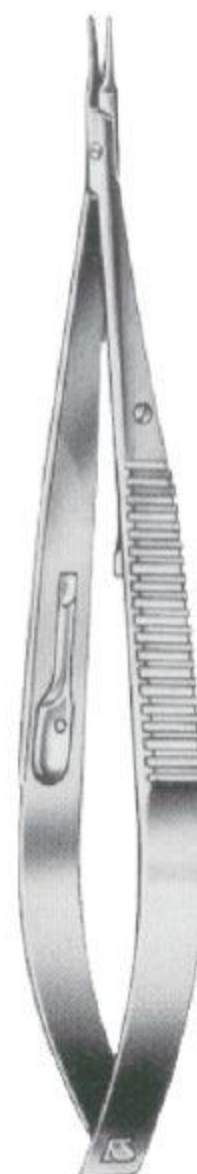

Castroviejo
14 cm/5 1/2"



Paton
09-2560-11
11.5 cm/4 1/2"



Jacobson

cm	in	Without ratchet	With ratchet
18	7"	09-2561-18	09-2562-18
21	8 1/4"	09-2561-21	09-2562-21



Straight
09-2563-15
15 cm/6"



Curved
09-2564-15
15 cm/6"

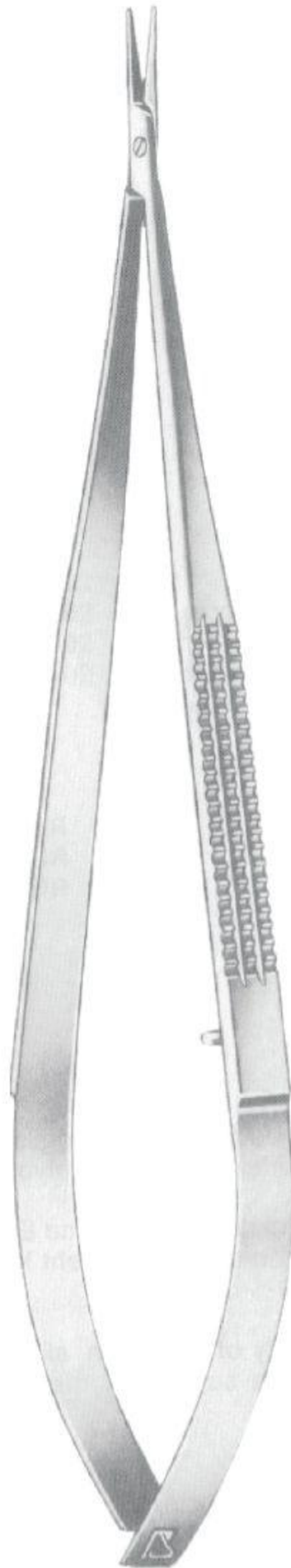

Straight
09-2565-18
18 cm/7"



Curved
09-2566-18
18 cm/7"

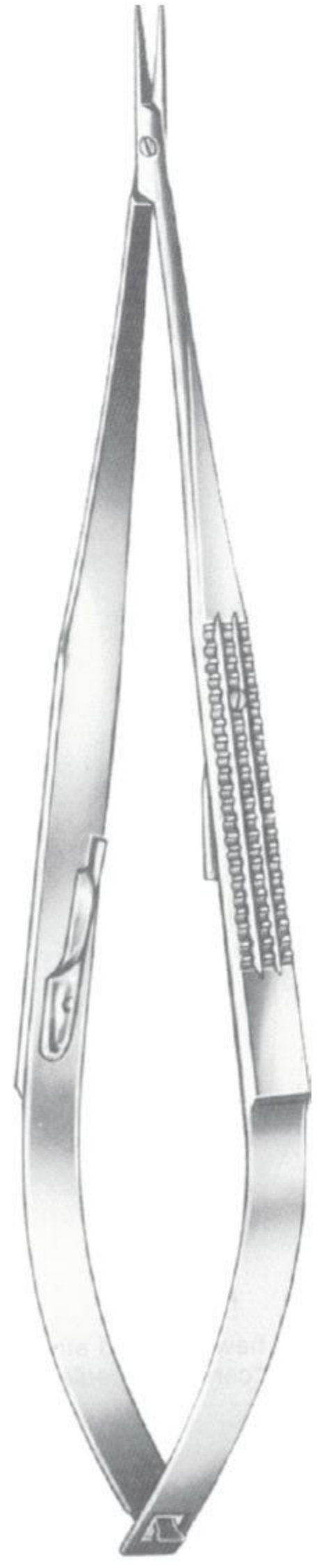

Straight
09-2567-18
18 cm/7"

Micro Needle Holders ● EN
 Mikro Nadelhalter ● DE
 Micro-porta-agujas ● ES

Straight



09-2568-18
 09-2568-22

Curved

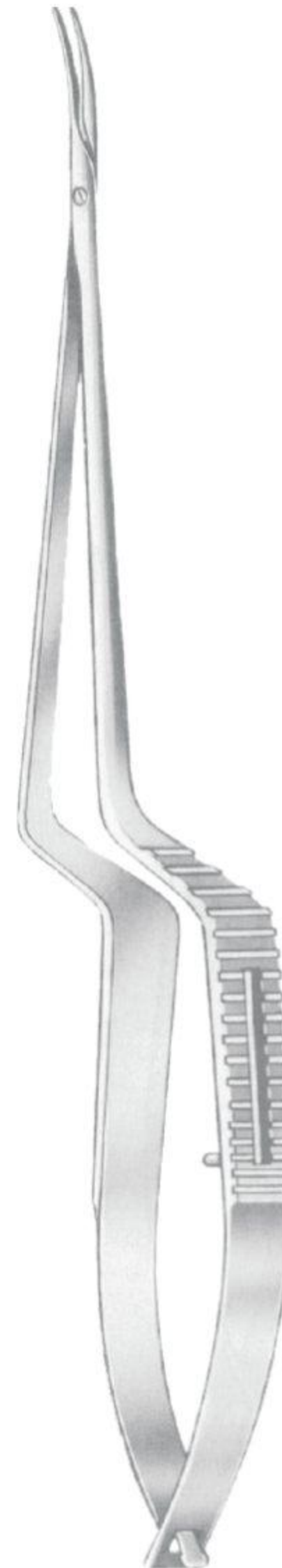

09-2569-18
 09-2569-22

Yasargil
 18.0 cm/7"
 22.5 cm/8¾"



Straight
09-2570-15
15 cm/6"



Curved
09-2571-15
15 cm/6"



Straight
09-2572-15
15 cm/6"



Curved
09-2573-15
15 cm/6"

Micro Needle Holders ● EN
 Mikro Nadelhalter ● DE
 Micro-porta-agujas ● ES



Straight
 09-2574-18
 18.5 cm/7¼"



Curved
 09-2575-18
 18.5 cm/7¼"



Straight
 09-2576-18
 18.5 cm/7¼"



Curved
 09-2577-18
 18.5 cm/7¼"



23 cm/9"





Straight
09-2580-12
12 cm/4¾"



Curved
09-2581-12
12 cm/4¾"



Angled
09-2582-12
12 cm/4¾"



Straight
09-2583-12
12 cm/4¾"



Curved
09-2584-12
12 cm/4¾"



Angled
09-2585-12
12 cm/4¾"

Micro Needle Holders ●— EN
 Mikro Nadelhalter ●— DE
 Micro-porta-agujas ●— ES



Arruga
 14 cm/5½"

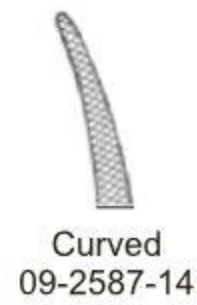
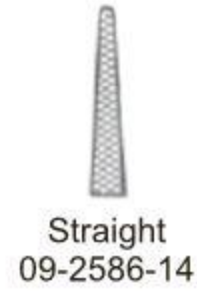

Stevens
 09-2588-13 13 cm/5"
 09-2588-15 15 cm/6"



Kalt
 09-2589-14
 14 cm/5½"



Castroviejo-Kalt
 09-2590-13
 13.5 cm/5¼"



Kalt-Arruga
 09-2591-14
 14 cm/5½"

Left



20 cm/8"



09-2592-01



Blunt



09-2593-02



09-2594-01



Sharp



09-2595-02

Deschamps-Standard

Right



20 cm/8"



20 cm/8"



09-2596-01



Blunt



09-2597-02



09-2598-01



Sharp



09-2599-02

Deschamps



20 cm/8"

Ligature Needles ●— EN
 Unterbindungsnadeln ●— DE
 Agujas para ligaduras ●— ES

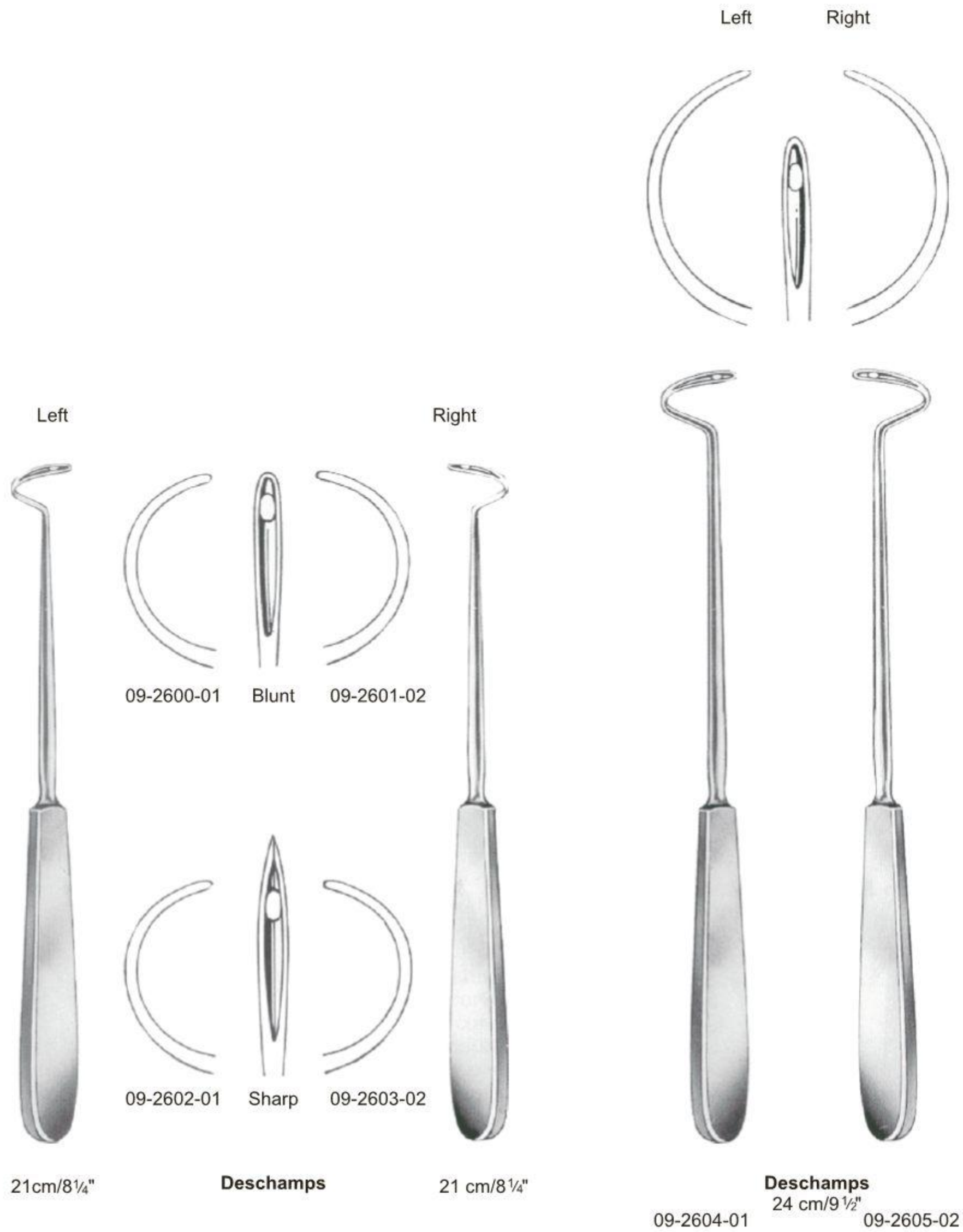

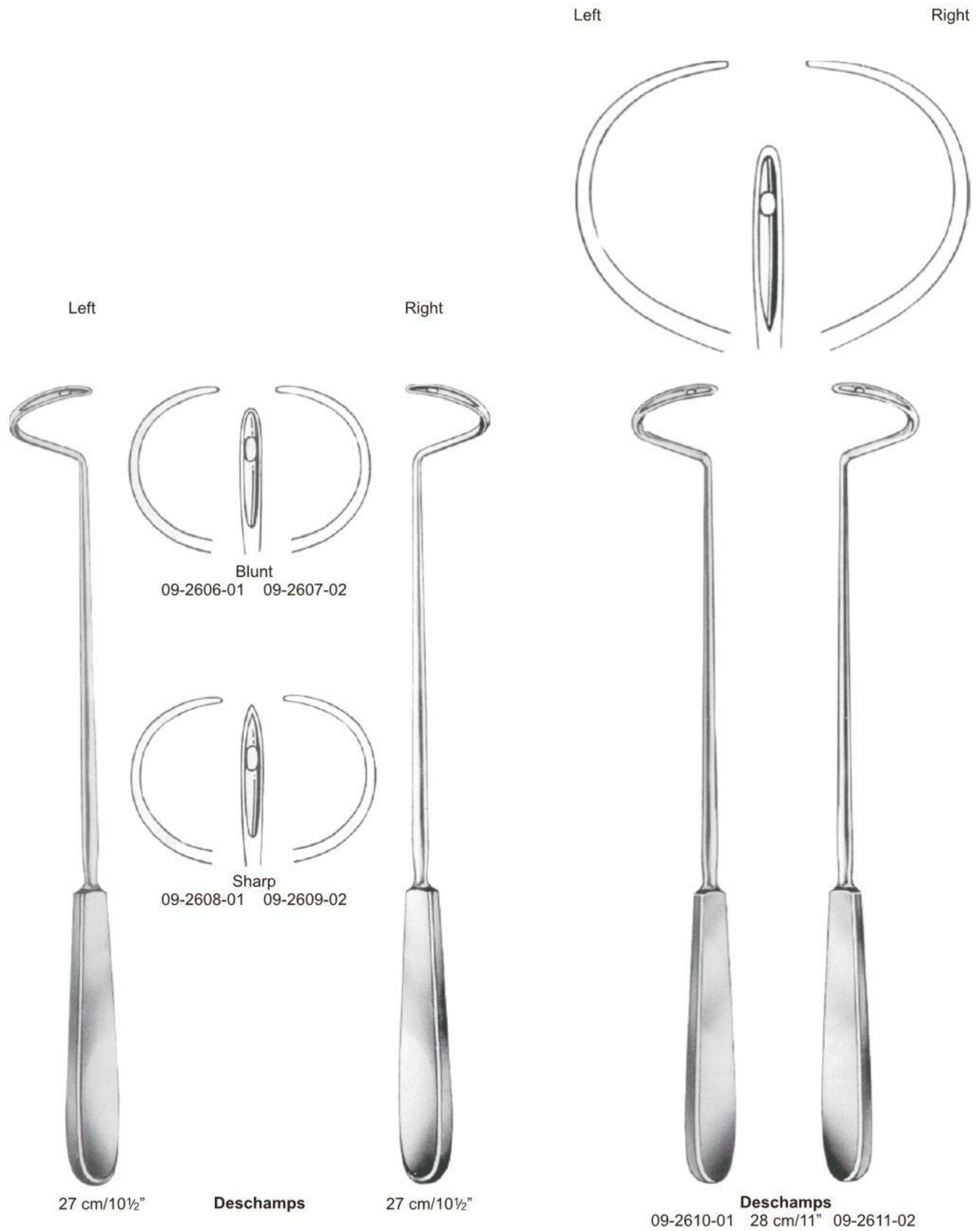

Ligature Needles ●— EN
 Unterbindungsnadeln ●— DE
 Agujas para ligaduras ●— ES



09-2612-01

09-2613-02

09-2614-03

Kocher
 19 cm/7½"



Kronecker
 09-2615-01 13 cm/5" 09-2616-02



Dupuy-Weiss
 09-2617-01 22 cm/8¾" 09-2618-02



Durham
 09-2619-01 21 cm/8¼" 09-2620-02



Young
09-2621-21 21 cm/8¼"
09-2622-25 25 cm/10"



Reverdin
14 cm/5½"



Fig. 1
09-2624-01



Fig. 2
09-2624-02



Fig. 3
09-2624-03



Fig. 4
09-2624-04



Brunner
09-2625-25
25 cm/10"



Payr
09-2626-22
22 cm/8¾"



Payr
09-2627-22
22 cm/8¾"

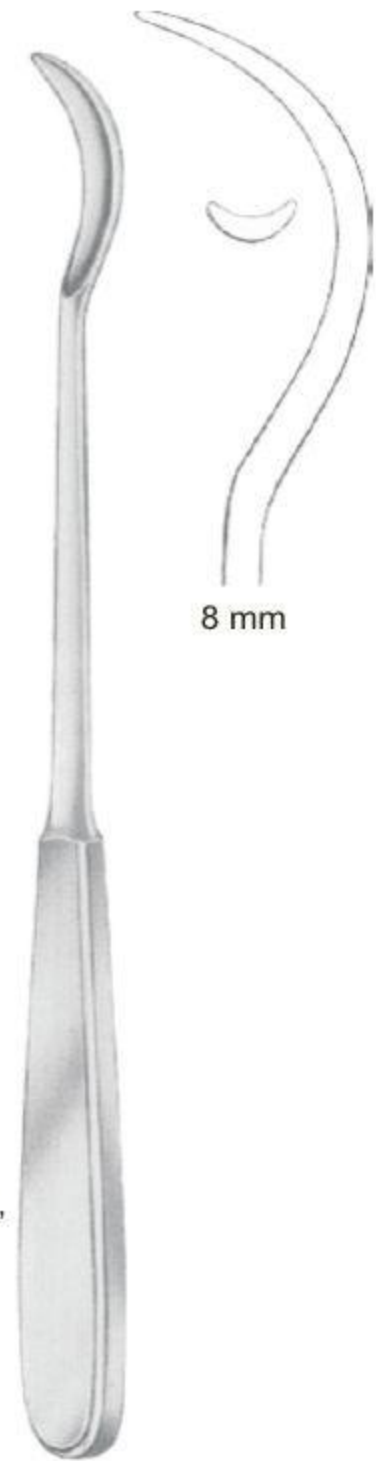

Brunner
09-2628-24
24.5 cm/9¾"

8 mm

Reverdin Needles ●— EN
 Reverdin Nadeln ●— DE
 Aguja de Reverdin ●— ES



Reverdin
 19.5 cm/7¾"



Fig. 1
 09-2629-01



Fig. 2
 09-2629-02



Fig. 3
 09-2629-03



Fig. 4
 09-2629-04



Reverdin
 22.5 cm/8¾"



Fig. 1
 09-2630-01



Fig. 2
 09-2630-02



Fig. 3
 09-2630-03



Fig. 4
 09-2630-04



Castroviejo

14cm/5½"
18cm/7"
21cm/8¼"



09-2631-14
09-2631-18
09-2631-21

Smooth



09-2632-14
09-2632-18
09-2632-21



14cm/5½"
18cm/7"
21cm/8¼"

09-2633-14
09-2633-18
09-2633-21



09-2634-14
09-2634-18
09-2634-21



Kalt
14cm/5½"



09-2635-14



09-2636-14



Barraquer
09-2637-14
14cm/5 ½"



Castroviejo
09-2638-13
13cm/5"



09-2639-18



09-2640-18

Smooth



Hepp-Schiedel
18cm/7"

Needle Holders ●— EN
 Nadelhalter ●— DE
 Porta-agujas ●— ES

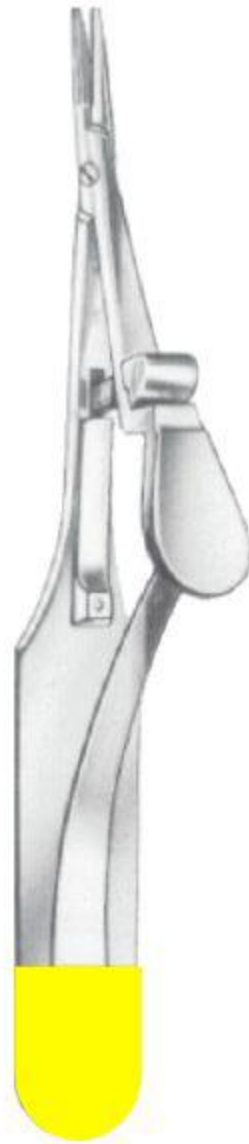

Arruga
14cm/5½"

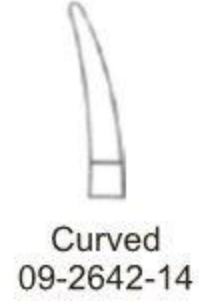

Jacobson
 09-2643-18 18cm/7"
 09-2643-20 20cm/8"
 09-2643-23 23cm/8¾"



Diethrich

Straight		Curved
09-2644-16	16cm/6¼"	09-2645-16
09-2644-18	18cm/7"	09-2645-18
09-2644-20	20cm/8"	09-2645-20
09-2644-23	23cm/9"	09-2645-23
09-2644-25	25cm/10"	09-2645-25

Two rings angled



Neivert
09-2646-13
13 cm/5"



Neivert
09-2647-13
13 cm/5"

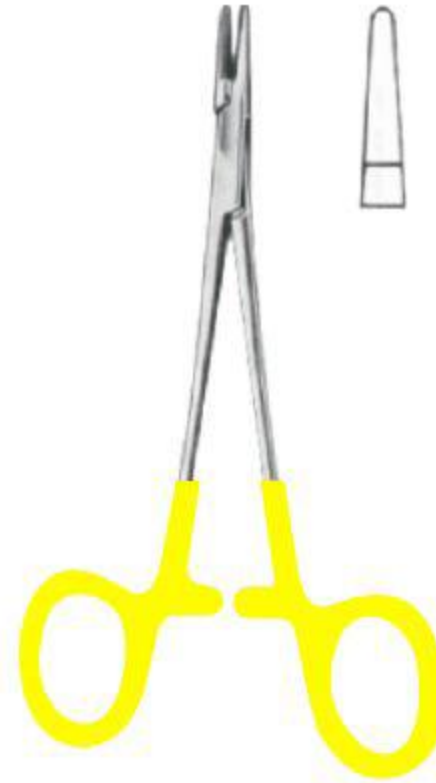

Webster
09-2648-13
13 cm/5"



Derf
09-2649-12
12.5 cm/5"



New Orleans
09-2650-18
18 cm/7"



Bozemann
09-2651-20 20 cm/8"
09-2651-24 24 cm/9½"
09-2651-26 26 cm/10½"



Mayo-Hegar



09-2652-16
 09-2652-18
 09-2652-20
 09-2652-24
 09-2652-26
 09-2652-30

09-2653-20
 09-2653-24
 09-2653-26

16cm/6¼"
 18cm/7"
 20cm/8"
 24cm/9½"
 26cm/10½"
 30cm/12"

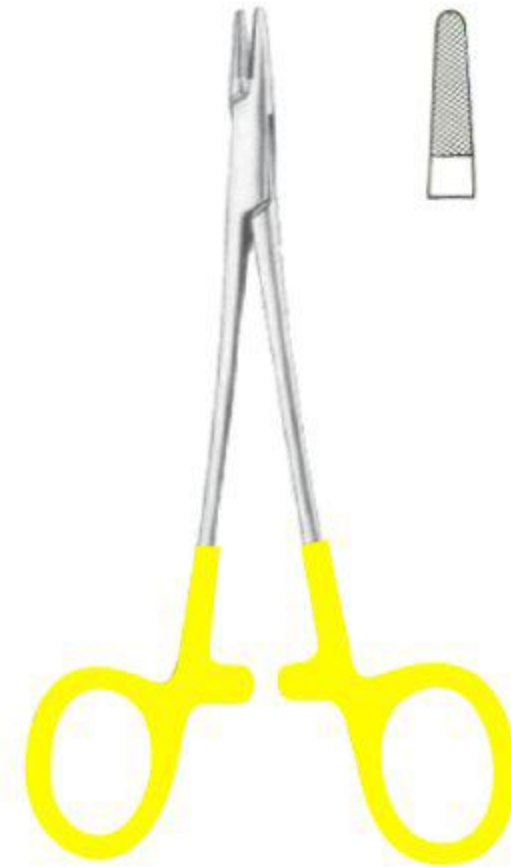

Hegar-Baumgartner

09-2654-14
 14cm/5½"



Mayo-Hegar
 09-2655-20 20cm/8"
 09-2655-24 24cm/9½"



De Bakey
 09-2656-18 18cm/7"
 09-2656-20 20cm/8"
 09-2656-23 23cm/9"
 09-2656-26 26cm/10¼"
 09-2656-31 31cm/12¼"



De Bakey-Fine
 09-2657-18 18cm/7"
 09-2657-20 20cm/8"
 09-2657-23 23cm/9"
 09-2657-26 26cm/10¼"
 09-2657-31 31cm/12¼"



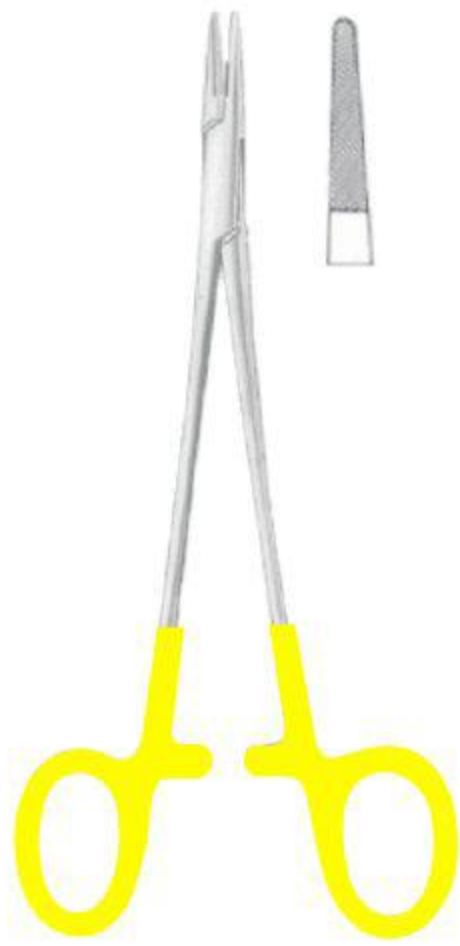

Baby-Crile-Wood
09-2658-15
15cm/6"

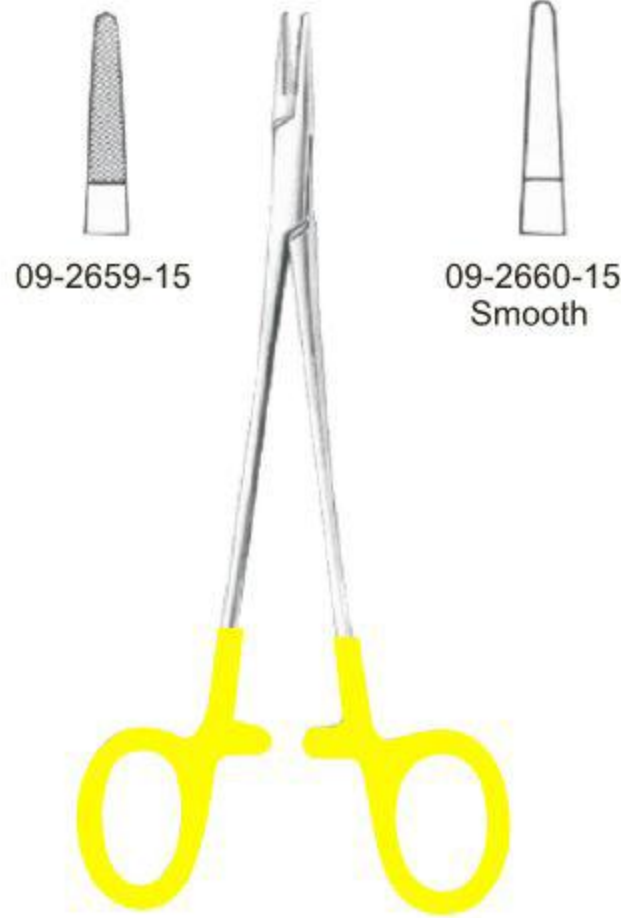

Crile-Wood
15cm/6"



Crile-Wood

	cm	in
09-2661-18	18	7"
09-2661-20	20	8"
09-2661-23	23	9"
09-2661-26	26	10 1/4"
09-2661-31	31	12 1/4"

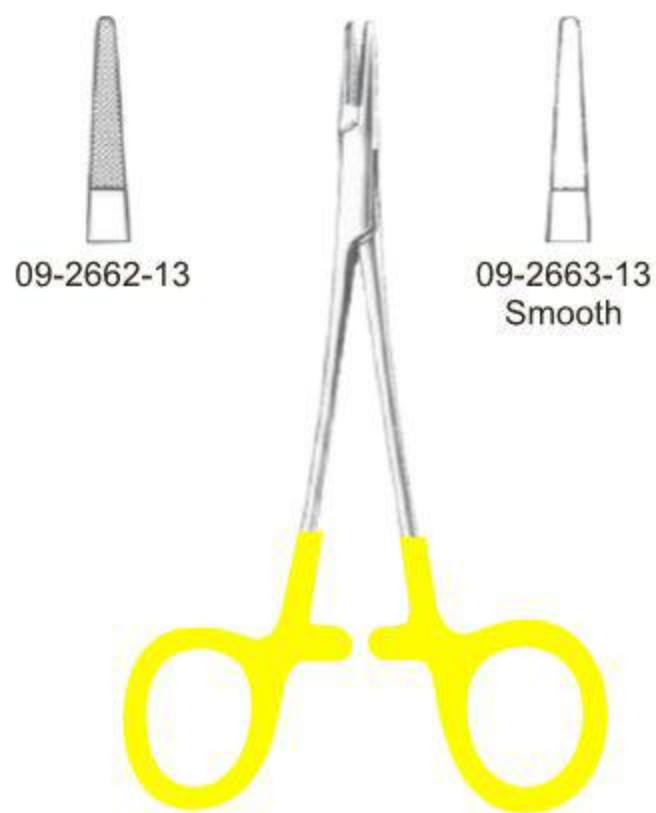

Halsey
13cm/5"

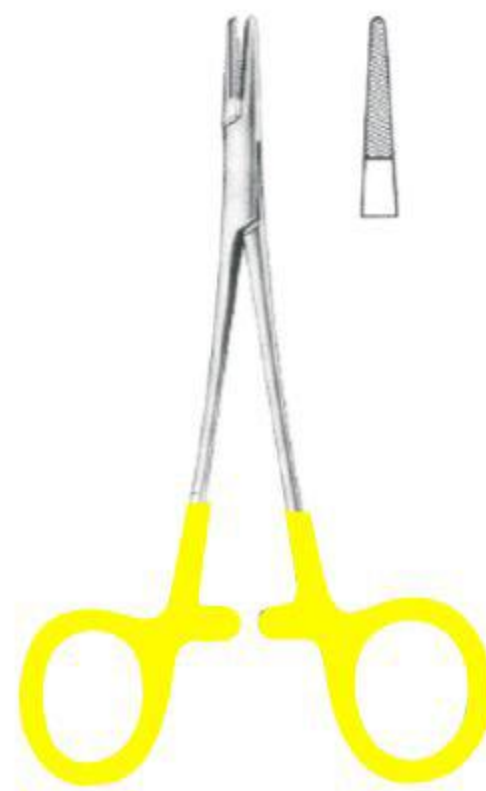

Converse
09-2664-12
12.5cm/5"

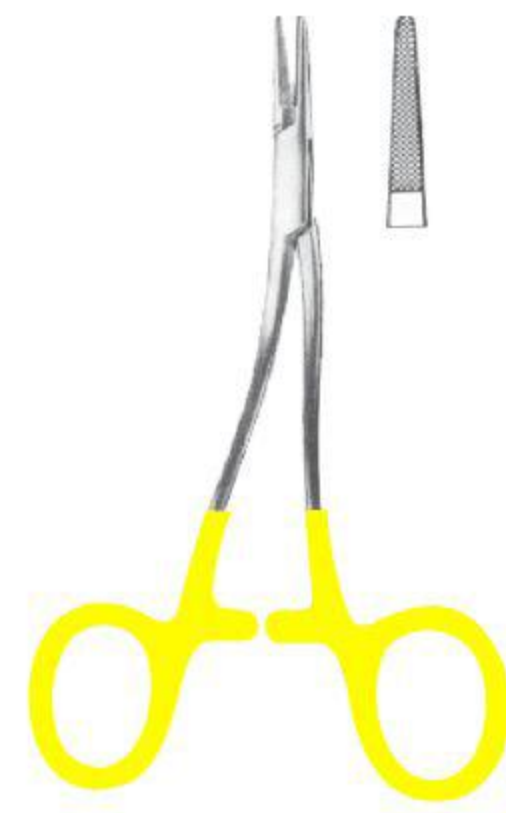

Kilner
09-2665-13
13.5cm/5 1/4"

Needle Holders ●— EN
 Nadelhalter ●— DE
 Porta-agujas ●— ES



Hegar-Vascular
 09-2666-14 14cm/5½"
 09-2666-18 18cm/7"
 09-2666-20 20cm/8"
 09-2666-23 23cm/9"



Ryder		Micro-Ryder	
09-2667-13		09-2668-13	13cm/5"
09-2667-15		09-2668-15	15cm/6"
09-2667-18		09-2668-18	18cm/7"
09-2667-20		09-2668-20	20cm/8"
09-2667-23		09-2668-23	23cm/9"
09-2667-26		09-2668-26	26cm/10¼"



(Swedish Pattern)
 09-2669-15 15cm/6"
 09-2669-17 17cm/6¾"
 09-2669-20 20cm/8"



Sarot
 09-2670-18 18cm/7"
 09-2670-26 26cm/10¼"

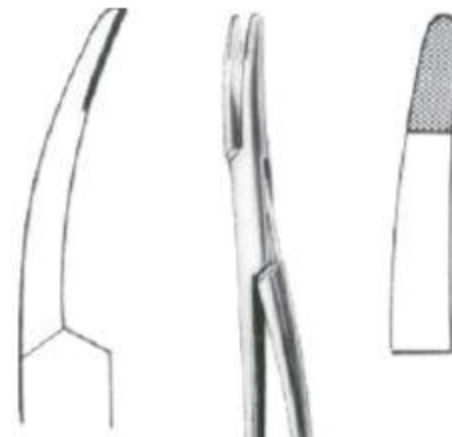

Stratte
 09-2671-23
 23cm/9"



Masson
 09-2672-27
 27cm/10½"



Wangensteen
 09-2673-27
 27cm/10½"



Finocchetto
 09-2674-20 20cm/8"
 09-2674-27 27cm/10½"

Needle Holders ● EN
 Nadelhalter ● DE
 Porta-agujas ● ES



Mathieu

14cm/5½"	09-2675-14
17cm/6¾"	09-2675-17
20cm/8"	09-2675-20
24cm/9½"	09-2675-24



Mathieu

09-2676-14
09-2676-17
09-2676-20
09-2676-24



Mathieu-Ryder

09-2677-17
09-2677-20



Langenbeck

16cm/6¼"	09-2678-16
18cm/7"	09-2678-18
20cm/8"	09-2678-20



Langenbeck-Ryder

09-2679-18
09-2679-20



Lichtenberg

09-2680-20



Toennis
09-2681-18
18 cm/7"



Mathieu-Kocher
09-2682-14 14 cm/5 1/2"
09-2682-17 17 cm/6 3/4"
09-2682-20 20 cm/8"



Axhausen
09-2683-18
18.5 cm/7 1/4"



Zweifel
09-2684-20 20 cm/8"
09-2684-23 23 cm/9"

Needle Holders ● EN
 Nadelhalter ● DE
 Porta-agujas ● ES



09-2685-20 20 cm/8"
 09-2685-25 25 cm/10"



Heavy Pattern

Mathieu
 09-2686-20 20 cm/8"
 09-2686-24 24 cm/9½"



Metzenbaum
 09-2687-17 17 cm/6¾"
 09-2687-20 20 cm/8"



09-2688-16



09-2689-16

Arruga
 16 cm/6¼"



Boynton
 09-2690-12 12 cm/4¾"



Hosel
 09-2691-20 20 cm/8"
 09-2691-25 25 cm/10"

Needle Holders ●— EN
 Nadelhalter ●— DE
 Porta-agujas ●— ES



Baby-Olsen-Hegar
 09-2692-11
 11.5 cm/4½"



Olsen-Hegar
 09-2693-14
 14 cm/5½"



Olsen-Hegar
 09-2694-17
 17 cm/6¾"



Olsen-Hegar
 09-2695-18
 18 cm/7"



Gillies-Slim
 09-2696-14
 14.5 cm/5½"

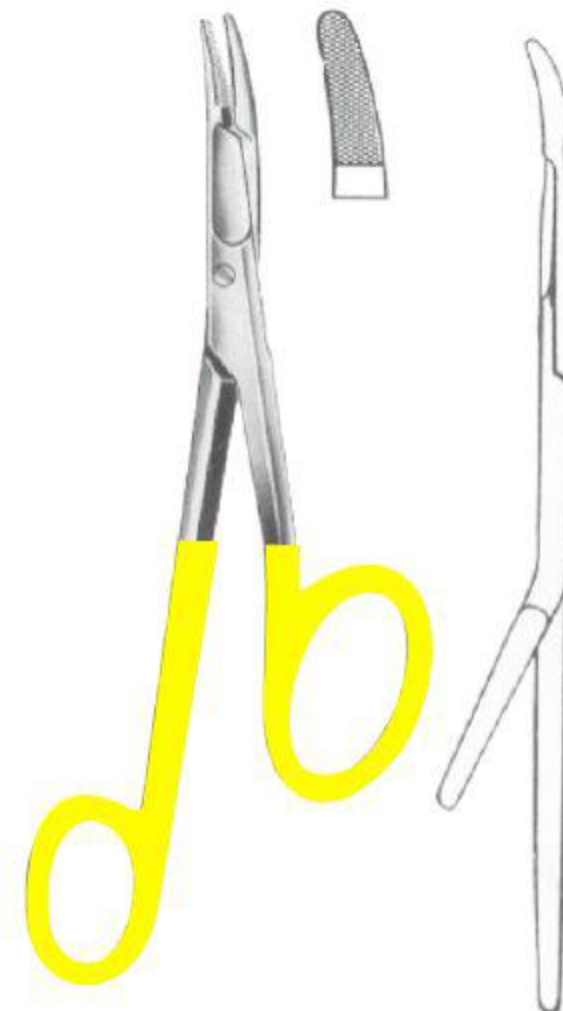

Gillies
 09-2697-16 (right hand)
 09-2698-16 (left hand)
 16 cm/6¼"

- EN** Probes, Applicators, Spatulas
- DE** Sonden, Watteträger, Spatel
- ES** Sondas, Porta-algodones, Espátulas

Page 176 to 181





cm	In	1.0 mmØ	1.5 mmØ	2.0 mmØ	2.0 mmØ	Watson-Cheyne	Fish
11.5	4 1/2"	10-2851-11	10-2852-11	10-2853-11			
13	5"	10-2851-13	10-2852-13	10-2853-13		10-2855-13	
14.5	5 3/4"	10-2851-14	10-2852-14	10-2853-14	10-2854-14	10-2855-14	10-2857-14
16	6 1/4"	10-2851-16	10-2852-16	10-2853-16	10-2854-16	10-2855-16	
18	7"	10-2851-18	10-2852-18	10-2853-18		10-2856-18	10-2857-18
20	8"	10-2851-20	10-2852-20	10-2853-20		10-2855-20	
25	10"	10-2851-25	10-2852-25	10-2853-25			



cm	In			Nelaton	Stacke 1.0 mm Ø	Brodie
10.5	4 1/4"				10-2863-10	
11.5	4 1/2"	10-2858-11				
13	5"	10-2858-13		10-2860-13		
14.5	5 3/4"	10-2858-14	10-2859-14	10-2860-14		
16	6 1/4"	10-2858-16		10-2860-16		10-2864-16
18	7"	10-2858-18		10-2860-18		
20	8"	10-2858-20			10-2861-20	

Probes, Plaster Spatulas, Cotton Applicators, Fistula Probes ●— EN

Sonden, Watterträger ●— DE

Estiletes, Porta-algodones ●— ES



Of tin

- 10-2865-25 25 cm/10"
- 10-2865-30 30 cm/12"
- 10-2865-40 40 cm/15¾"

Plaster spatulas



- 10-2866-13 13 cm/5"
- 10-2866-14 14 cm/5½"

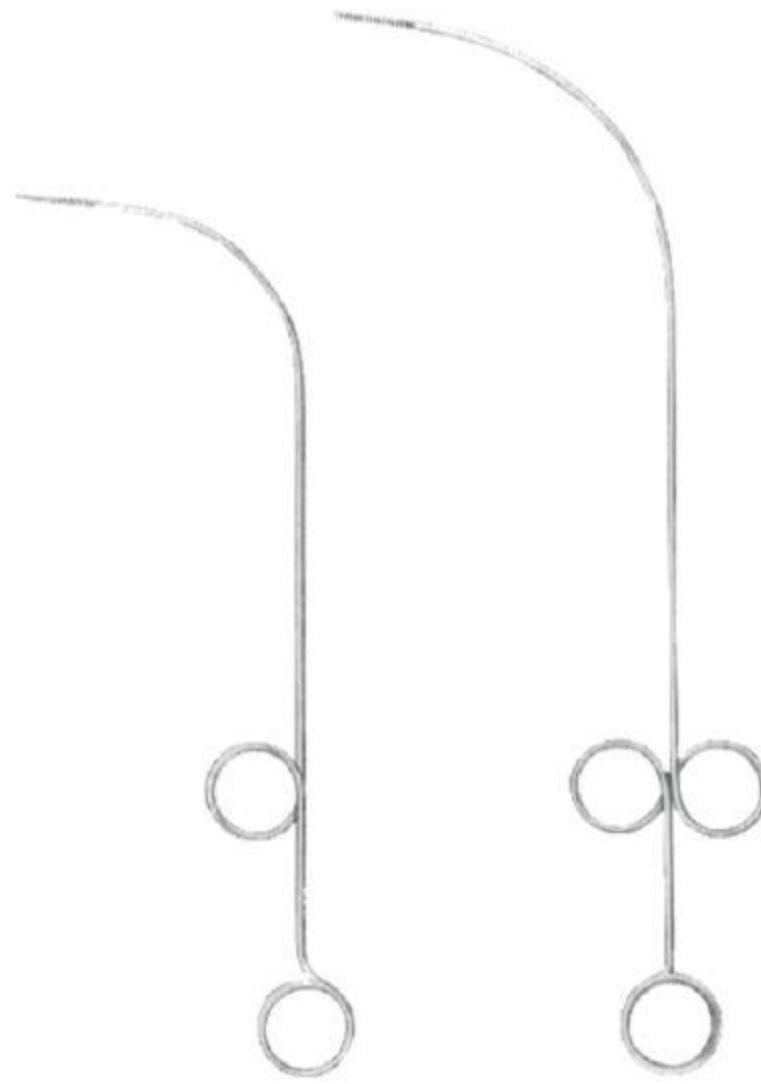

- Pelteson**
- 10-2867-23 23 cm/9"

- Fein**
- 10-2868-28 28 cm/11"



- Buie**
- 10-2869-16 16 cm/6¼"

Fistula probes



Lockhart-Mummary
16.5 cm/6½"

Fig. 1
10-2870-01



Fig. 2
10-2870-02



Fig. 3
10-2870-03



Fig. 4
10-2870-04



Pratt
21 cm/8¼"



10-2871-01

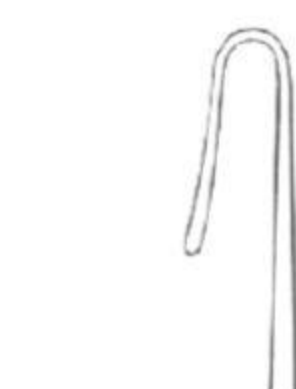

10-2871-02



10-2871-03



Universal

cm	in	1.2 mm Ø	1.5 mm Ø	1.7 mm Ø
12.5	5"	10-2872-12		
16	6¼"	10-2872-16		
18	7"	10-2872-18	10-2873-18	10-2874-18



Uckermann
 10-2875-16
 16 cm/6¼"



Jobson-Horne
 10-2876-13 13 cm/5"
 10-2876-18 18 cm/7"



Round Triangular

Farrell (Farrell-Lathbury)

cm	in		●	▲
12	4¾"			
14	5½"	0.9 mm Ø	10-2877-14	10-2878-14
16	6¼"	1.1 mm Ø	10-2877-16	10-2878-16
18	7"			



Round Triangular

●	●	▲
1.2 mm Ø	1.5 mm Ø	1.5 mm Ø
10-2879-12	10-2880-12	10-2881-12
10-2879-14	10-2880-14	10-2881-14
10-2879-16	10-2880-16	10-2881-16
10-2879-18	10-2880-18	10-2881-18

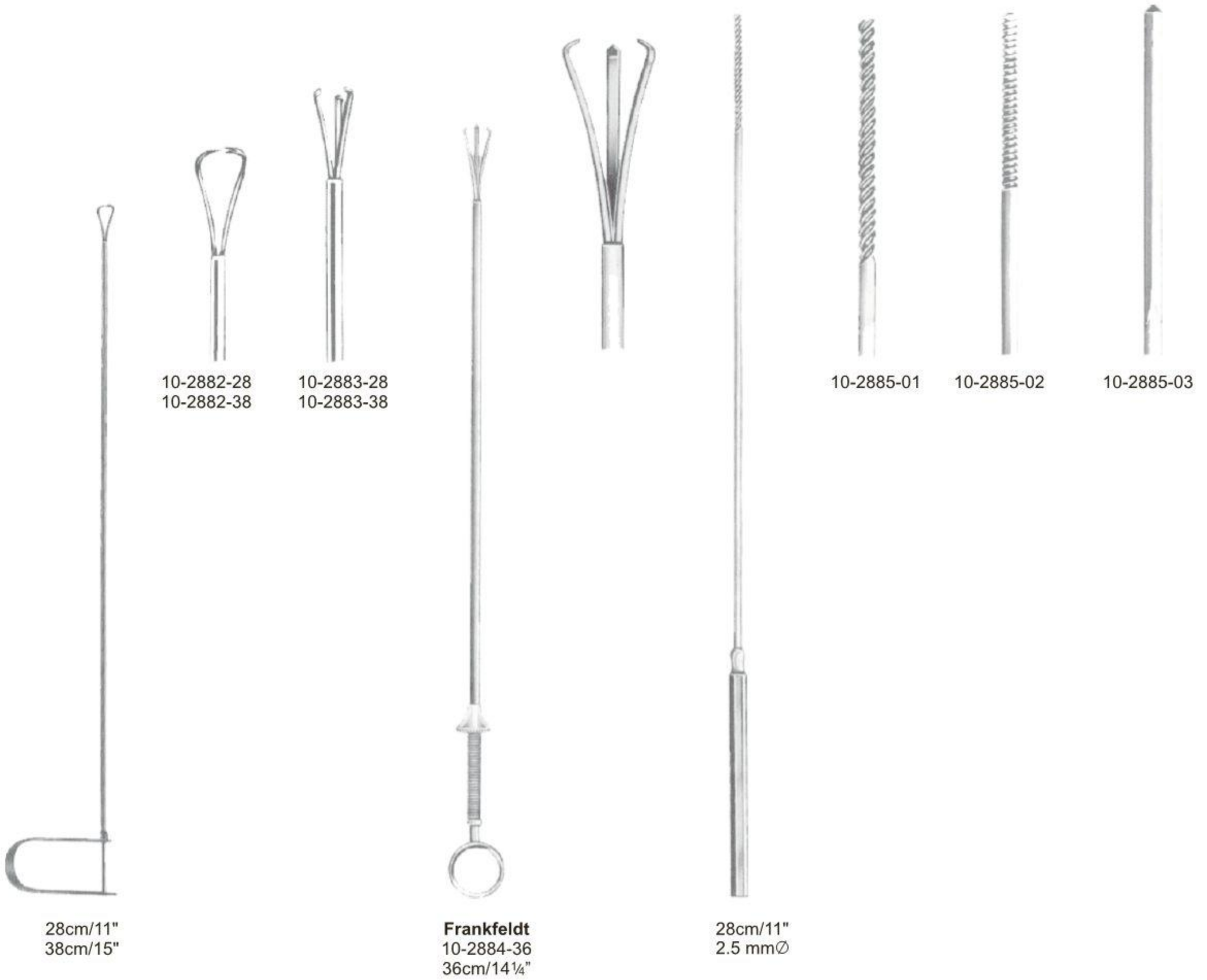

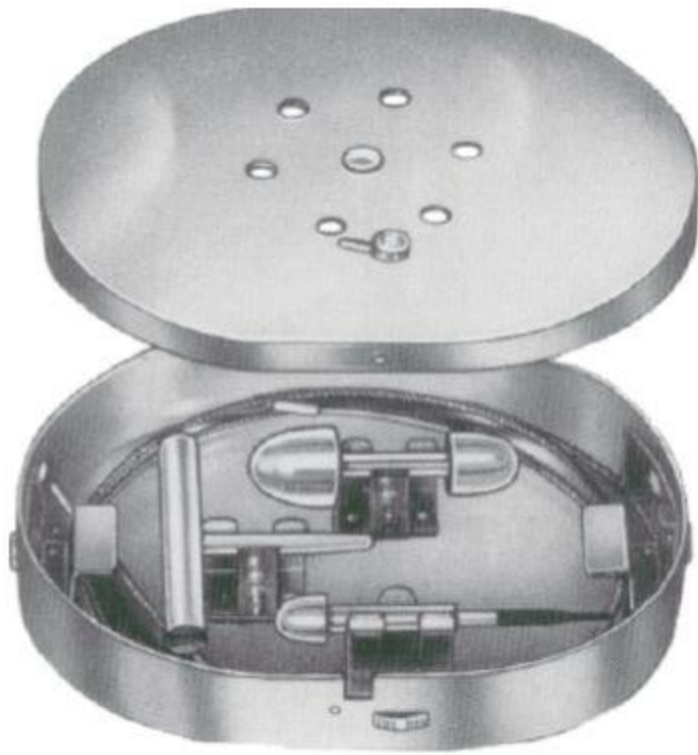

Nabatoff
10-2886-00
135x100x25 mm

Sterilizable

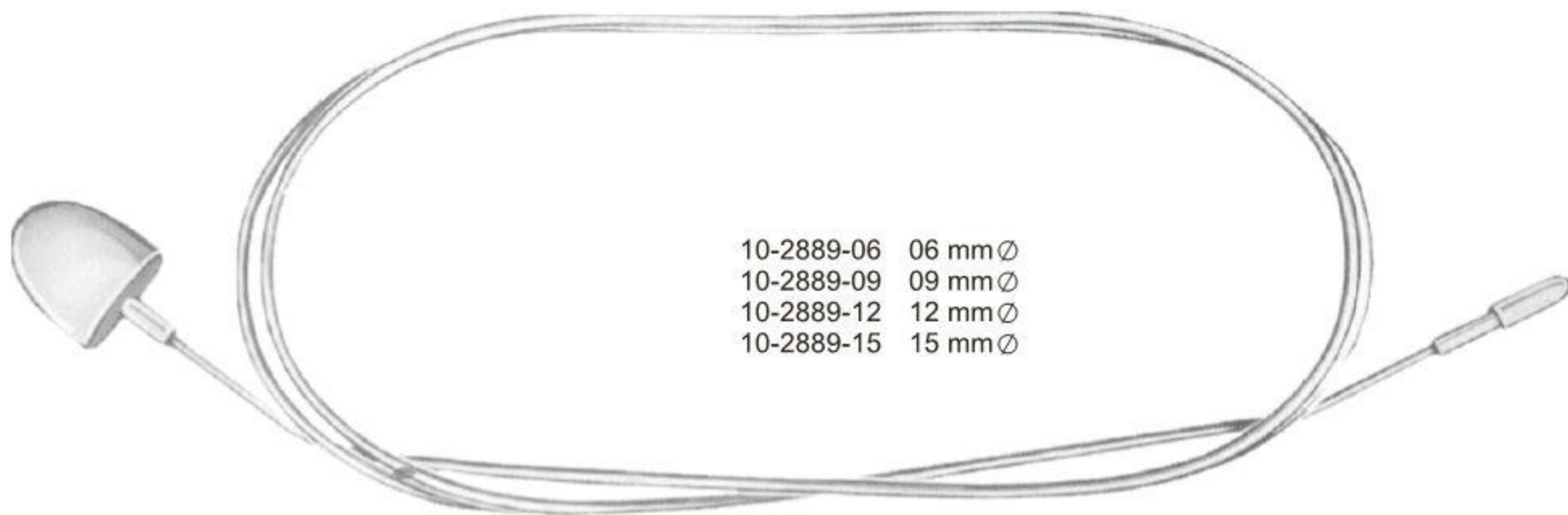
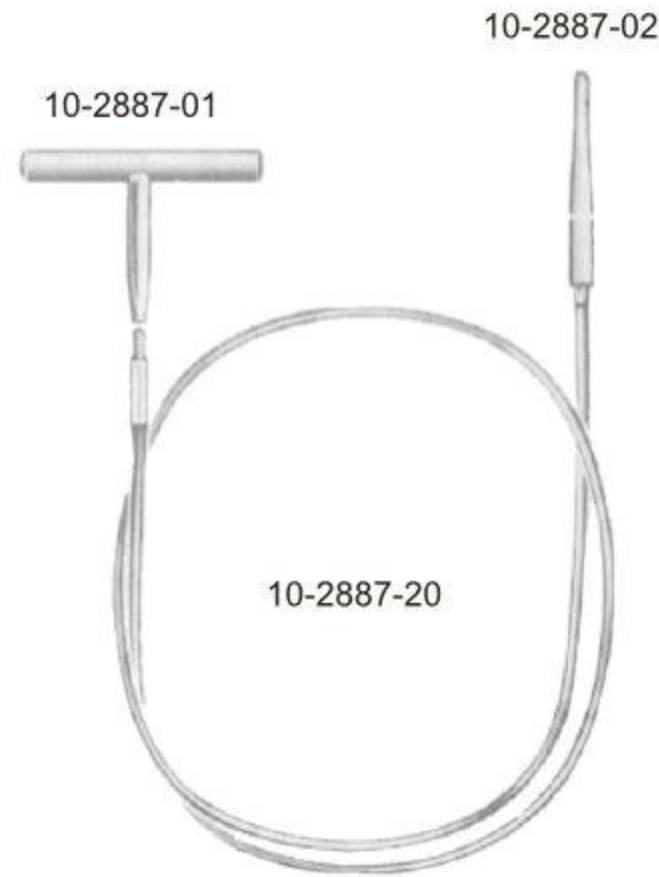

Myers

Strippers



55cm/21½"

	mm Ø
10-2890-02	2.0
10-2890-03	3.0
10-2890-04	4.0
10-2890-06	6.0
10-2890-07	7.0
10-2890-08	8.5
10-2890-10	10.0
10-2890-12	12.0
10-2890-14	14.0



Handle for 10-2890-00

Probes for Varicose Veins



Babcock

Malleable

cm	in	
40	13½"	10-2891-40
50	20"	10-2891-50
65	26"	10-2891-65
80	32"	10-2891-80

Vessel Irrigating Cannulas



Schimd



10-2892-03
3 mm Ø



10-2892-04
4 mm Ø



10-2892-05
5 mm Ø



10-2892-06
6 mm Ø

Spatulas

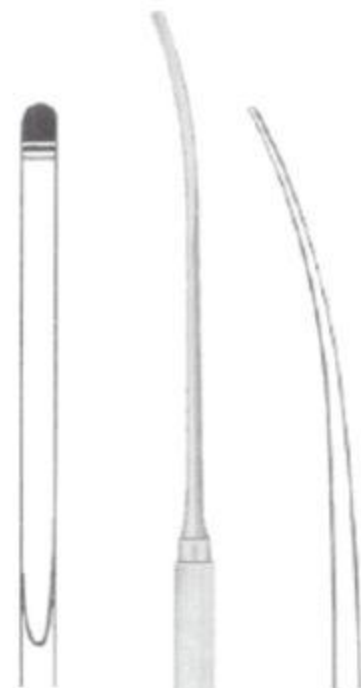

3 mm
Blunt

10-2893-18 18.0 cm/7"
10-2893-21 21.5 cm/8½"



Schmid



10-2894-14
14 cm/5½"
5 mm



10-2894-24
24 cm/9¼"
7 mm

- EN** Retractors
- DE** Wundhaken und -sperrer
- ES** Separadores

Page 182 to 241







11-3011-16
 16cm/6¼"



11-3012-08
 8 mm



11-3012-10
 10 mm

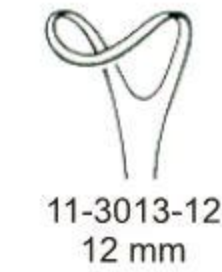

11-3013-12
 12 mm



11-3013-14
 14 mm

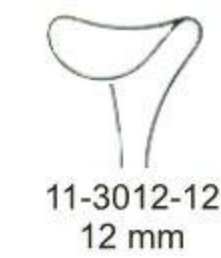

11-3012-12
 12 mm



11-3012-14
 14 mm



11-3013-16
 16 mm



11-3013-18
 18 mm



11-3012-16
 16 mm



11-3012-18
 18 mm



11-3014-16
Graefe
 16cm/6¼"

Sharp



11-3015-16

Blunt



11-3016-16
 16cm/6¼"



11-3017-16
 16cm/6¼"



O, Connor
 11-3018-16
 16cm/6¼"



11-3019-16
Guthrie
 16cm/6¼"



11-3020-16



11-3021-16
 16cm/6¼"



11-3022-16
 16cm/6¼"

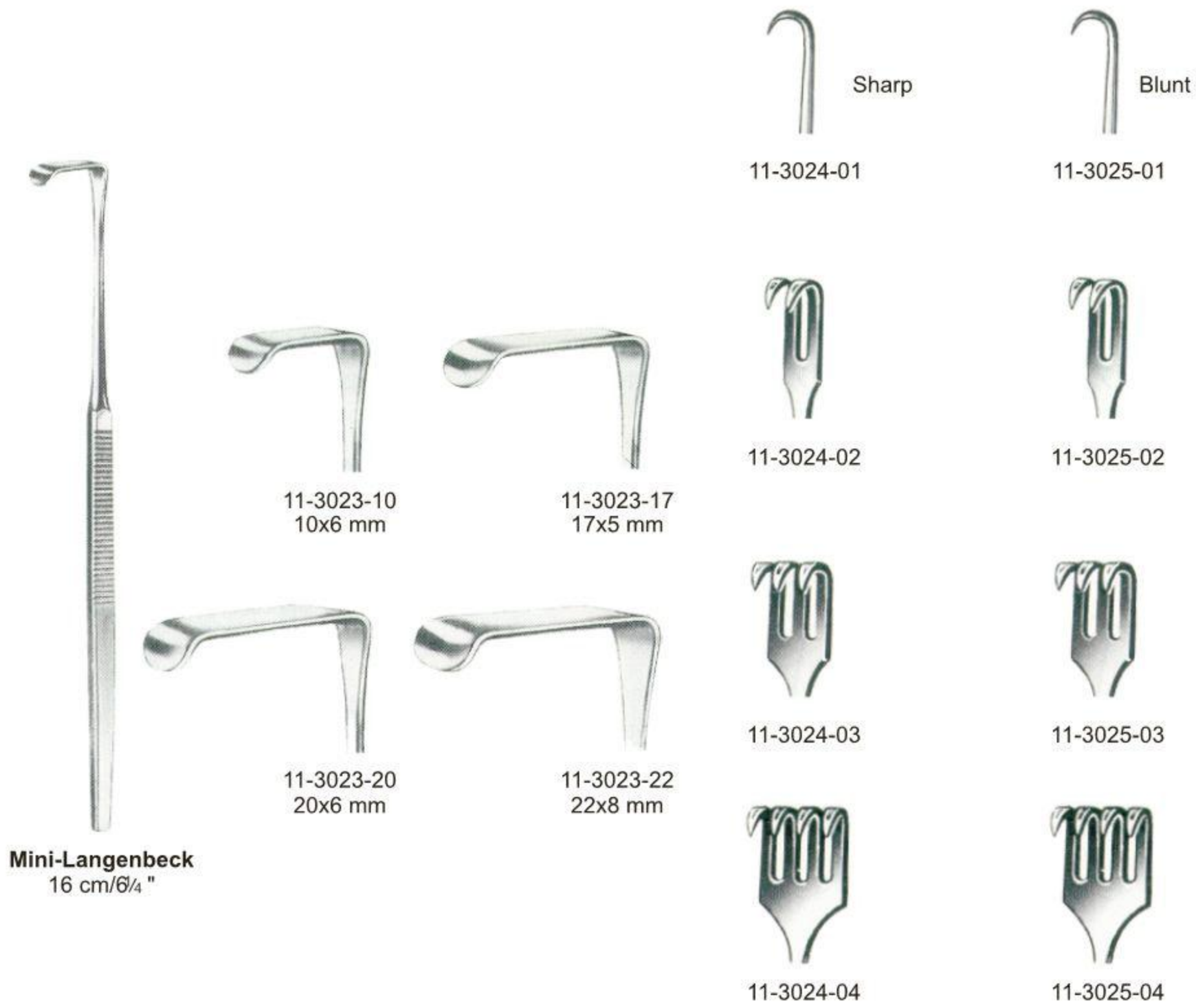

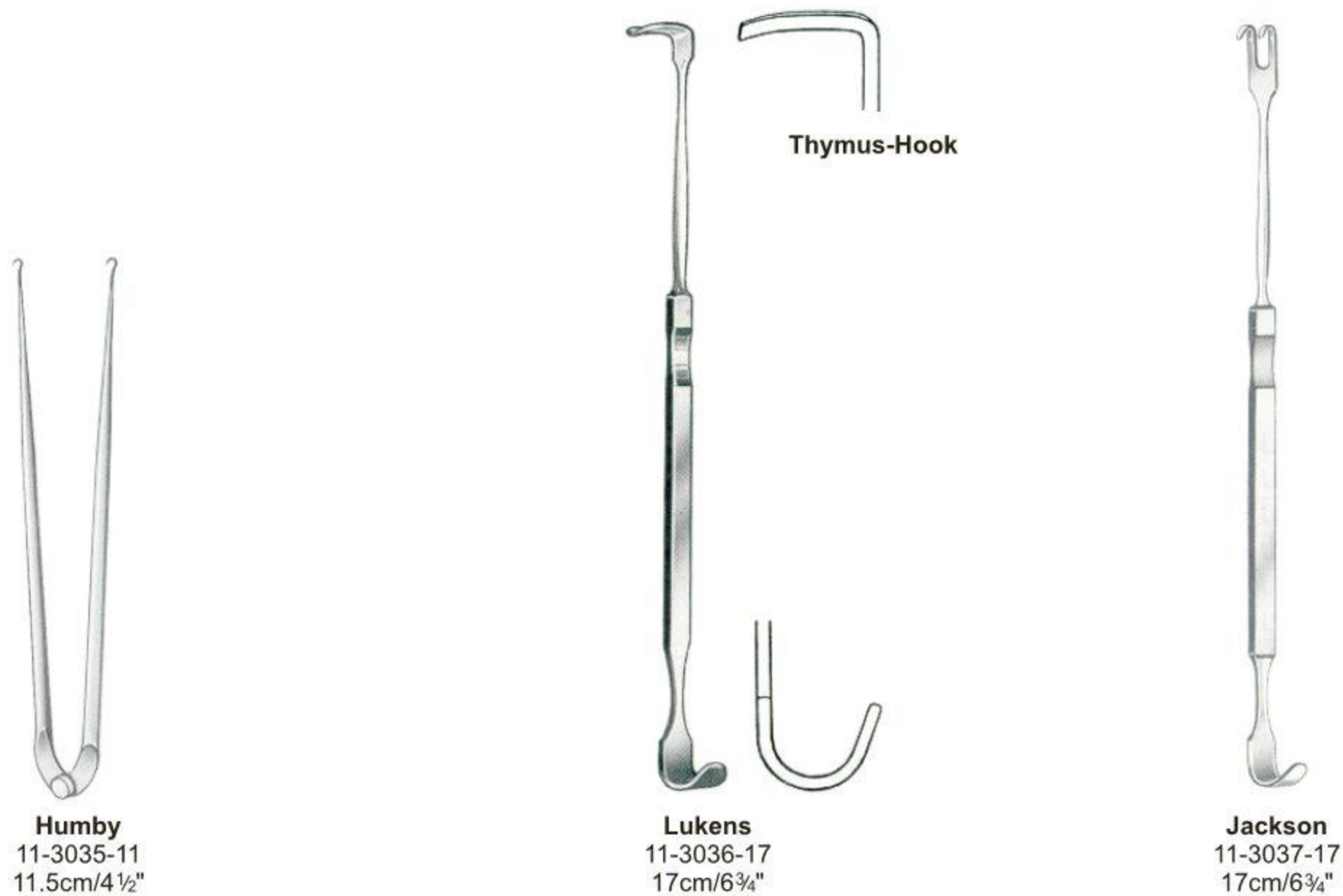

Malleable



Gil-Vernet
24cm/9½"

08 mm 11-3038-08	11-3039-08
11 mm 11-3038-11	11-3039-11
15 mm 11-3038-15	11-3039-15
17 mm 11-3038-17	11-3039-17
20 mm 11-3038-20	11-3039-20
23 mm 11-3038-23	11-3039-23

Malleable



24cm/9½"

12x14 mm



Little
11-3040-20
20cm/8"



Love-(Morse)
25cm/10"

10 mm 11-3041-10
15 mm 11-3041-15
20 mm 11-3041-20
30 mm 11-3041-30
40 mm 11-3041-40
50 mm 11-3041-50

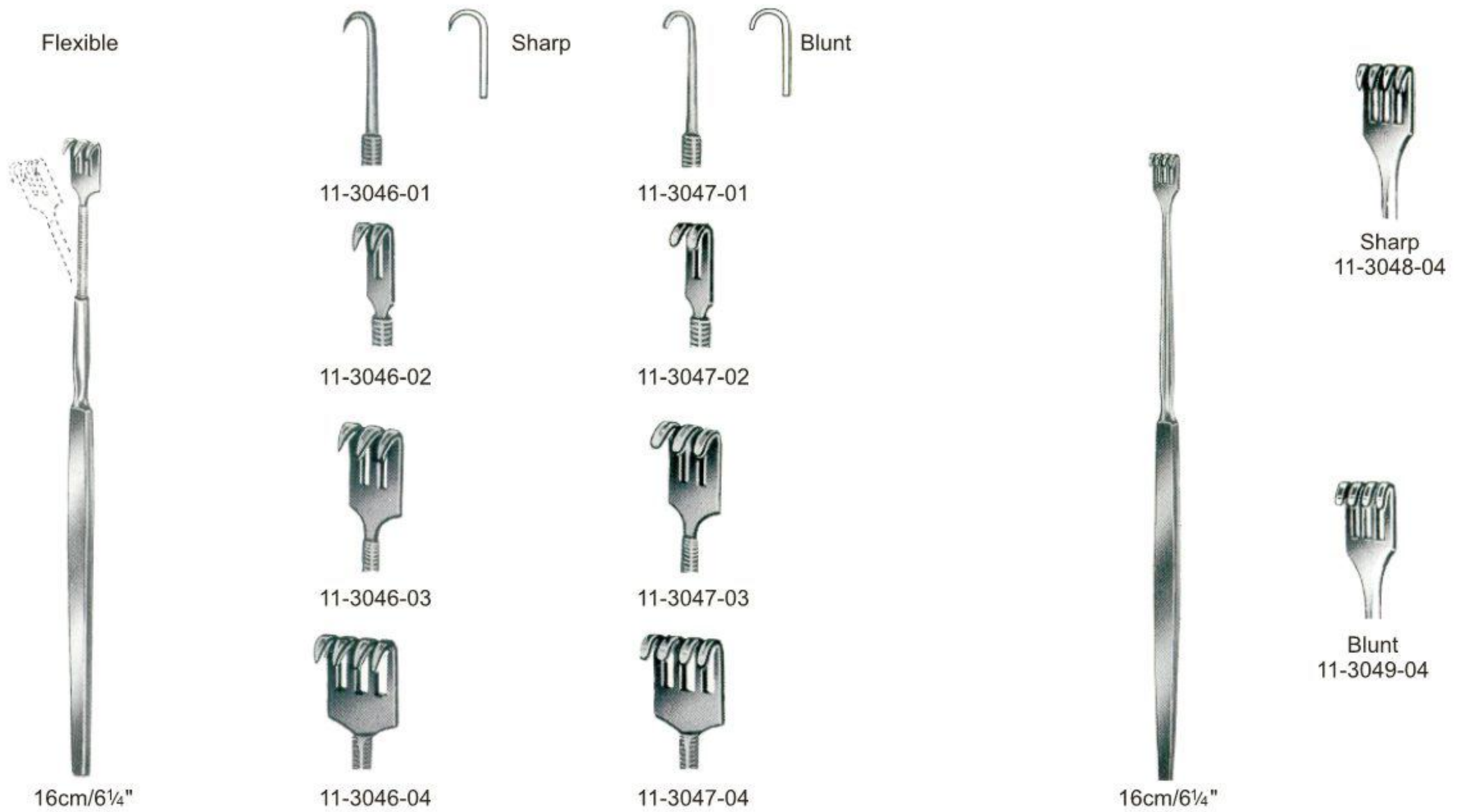
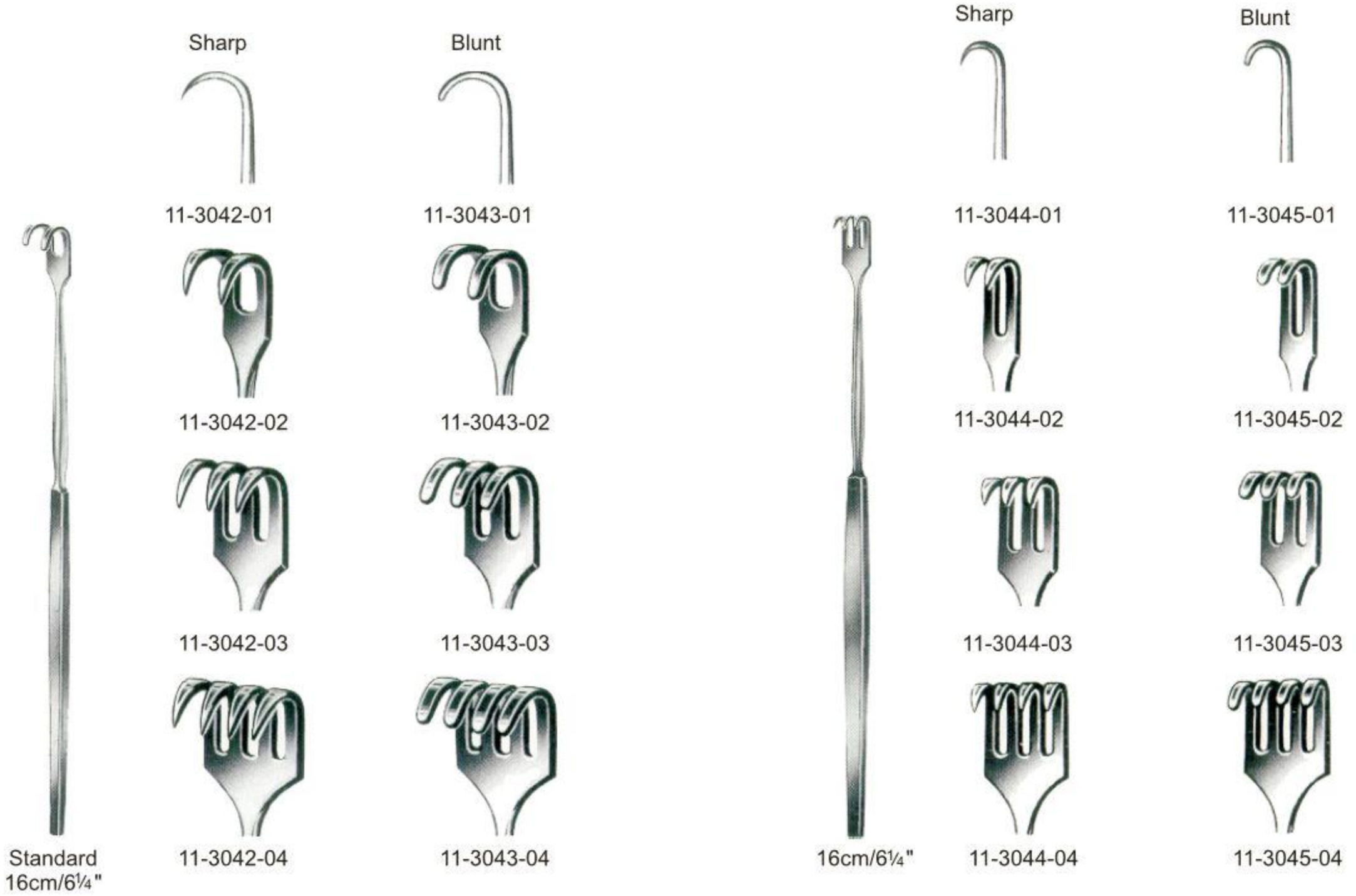



11-3050-02
13.5cm/5¼"



Jackson
11-3051-13
13cm/5"



Bergmann
11-3052-14
14cm/5½"



Iterson
16cm/6¼"



11-3053-16



11-3054-16



Meyerding
18cm/7"



11-3055-18
18x7 mm



11-3056-18
16x5 mm



11-3055-18
7x4 mm



11-3056-18
10x3 mm



11-3055-18
7x4 mm



11-3056-18



Volkmann
11.5cm/4½"



Sharp
11-3057-02



Blunt
11-3058-02



11-3057-03



11-3058-03



11-3057-04



11-3058-04



11-3057-06



11-3058-06

Retractors ●— EN
 Wundhaken ●— DE
 Separadores ●— ES

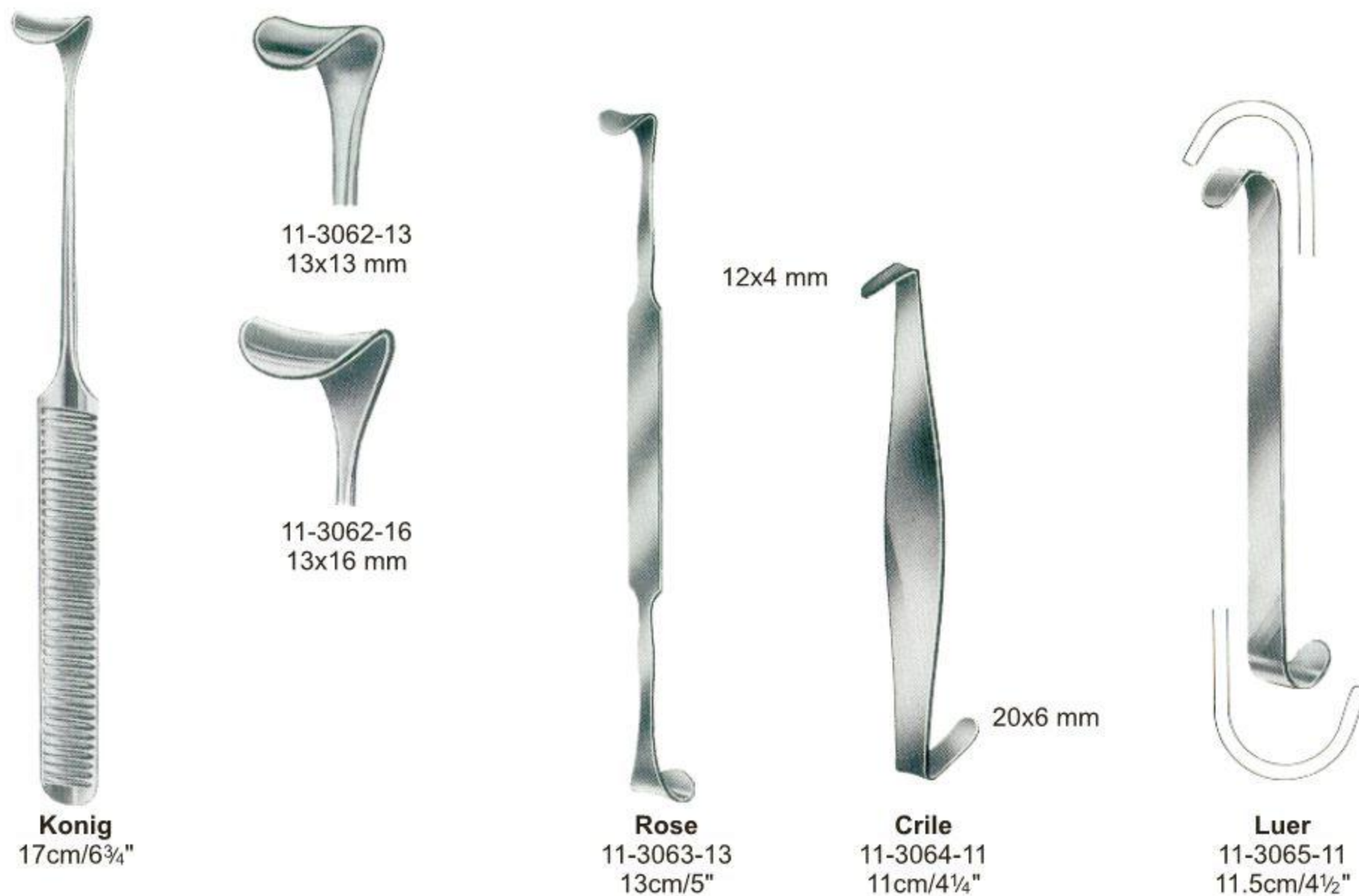
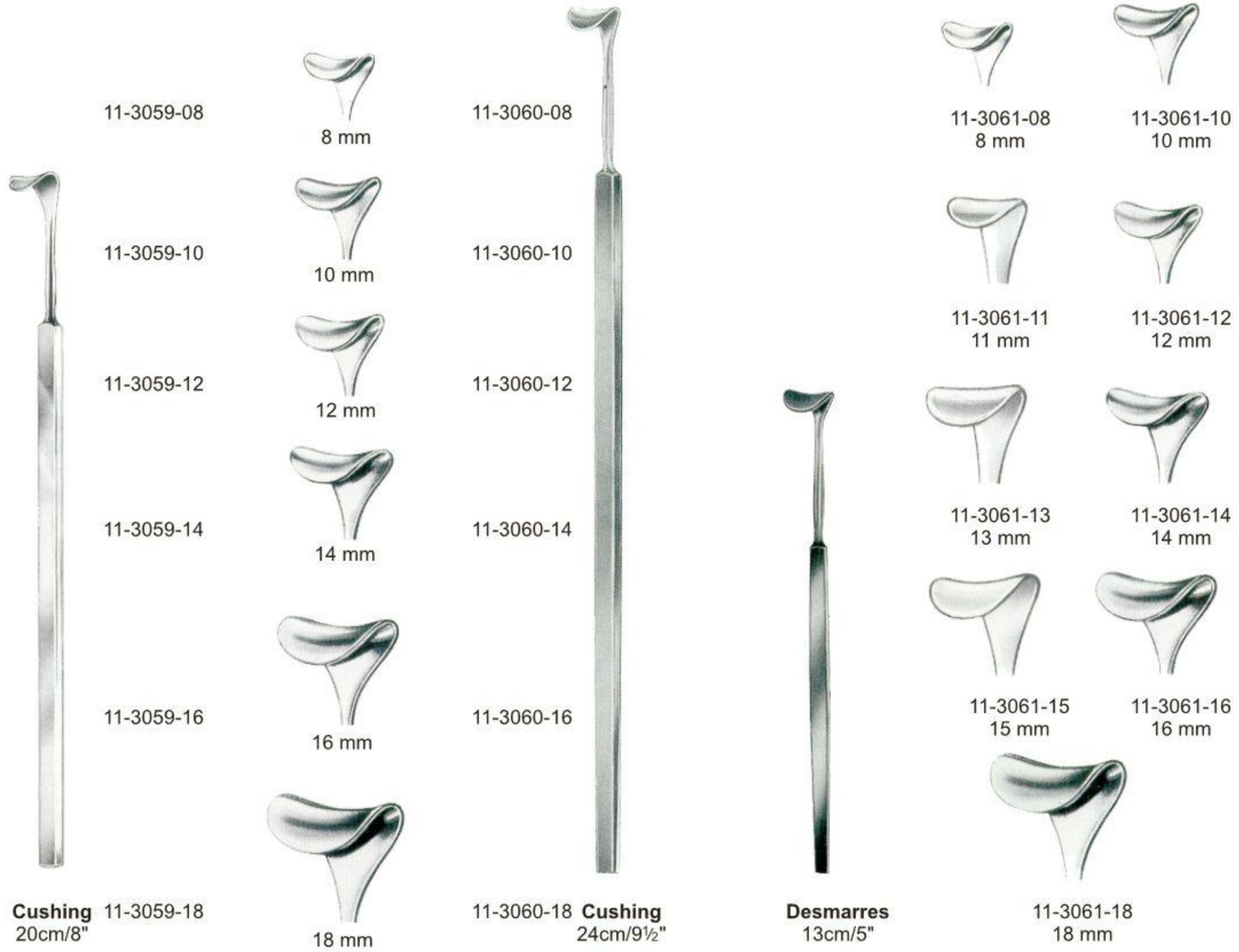

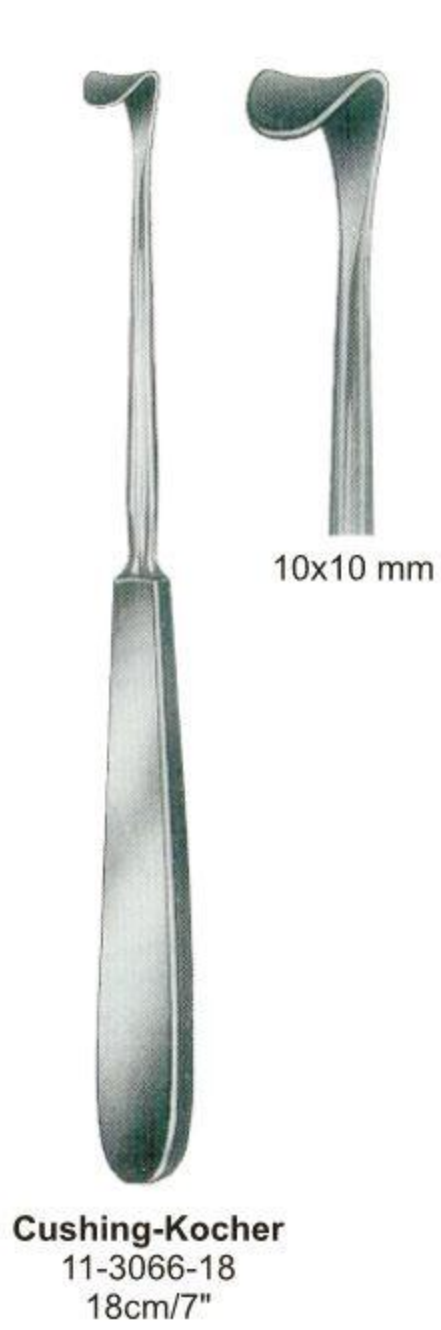

Tendon Sheath Hook



Decompression Hook





Senn-Miller
 16cm/6¼"

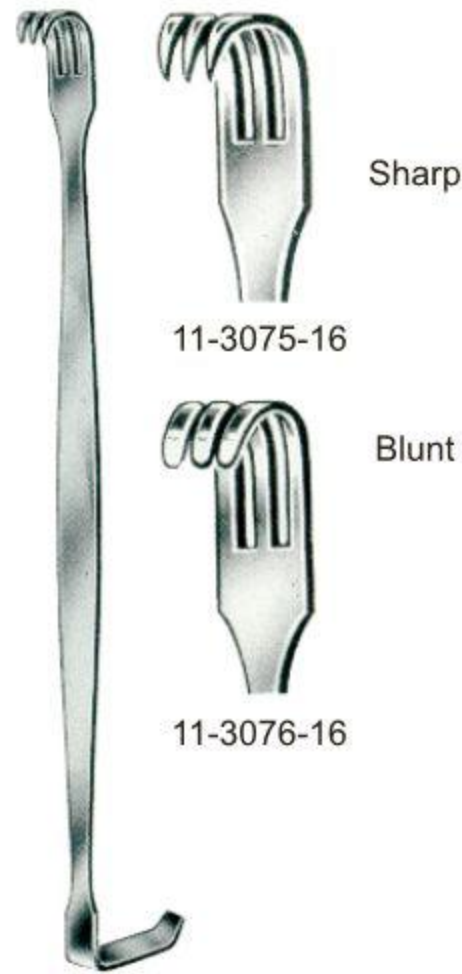

Baby-Senn-Miller
 16cm/6¼"



Rangell-Davis
 11-3077-14
 14cm/5½"



Senn-Green
 15cm/6"



Langenbeck-Green
 16cm/6¼"



Collin-Hartmann

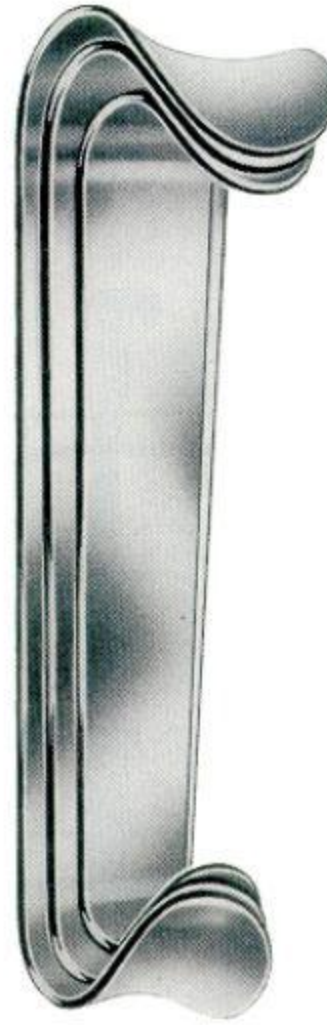

Roux



Baby-Roux
13 cm/5"



Mini-Roux
14 cm/5½"

Set	11-3084-00	Set	11-3085-00	11-3086-13	11-3087-14
14 cm/5½"	11-3084-01	14 cm/5½" Fig. 1	11-3085-01		
16 cm/6"	11-3084-02	15 cm/6" Fig. 2	11-3085-02		
		17 cm/6¾" Fig. 3	11-3085-03		

37x40 mm

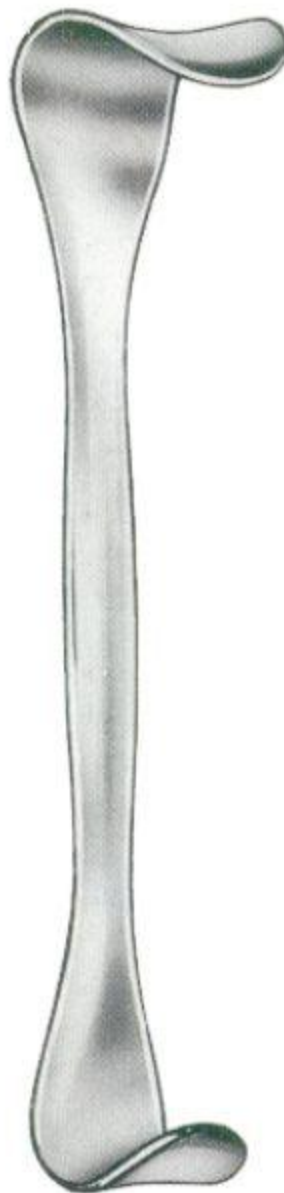

37x31 mm

Goelet
11-3088-19
19 cm/7½"



Parker-Langenbeck (US-Army)
11-3089-21
21cm/8¼"

Set



Parker
11-3090-13
13.5 cm/5¼"

Set



Parker
11-3091-18
18 cm/7"

Set

Retractors ● EN
 Wundhaken ● DE
 Separadores ● ES



Set

Parker-Mott
 11-3092-16
 16 cm/6¼"



Set

Farabeuf
 11-3093-12
 12 cm/4¾"



Set

Farabeuf
 11-3094-15
 15 cm/6"

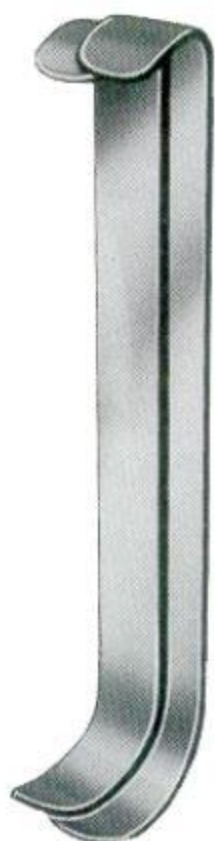

Set

Collin
 11-3095-16
 16.5 cm/6½"



Set

Mayo-Collin
 11-3096-15
 15 cm/6"



Set

Mathieu
 11-3097-19
 19 cm/7½"

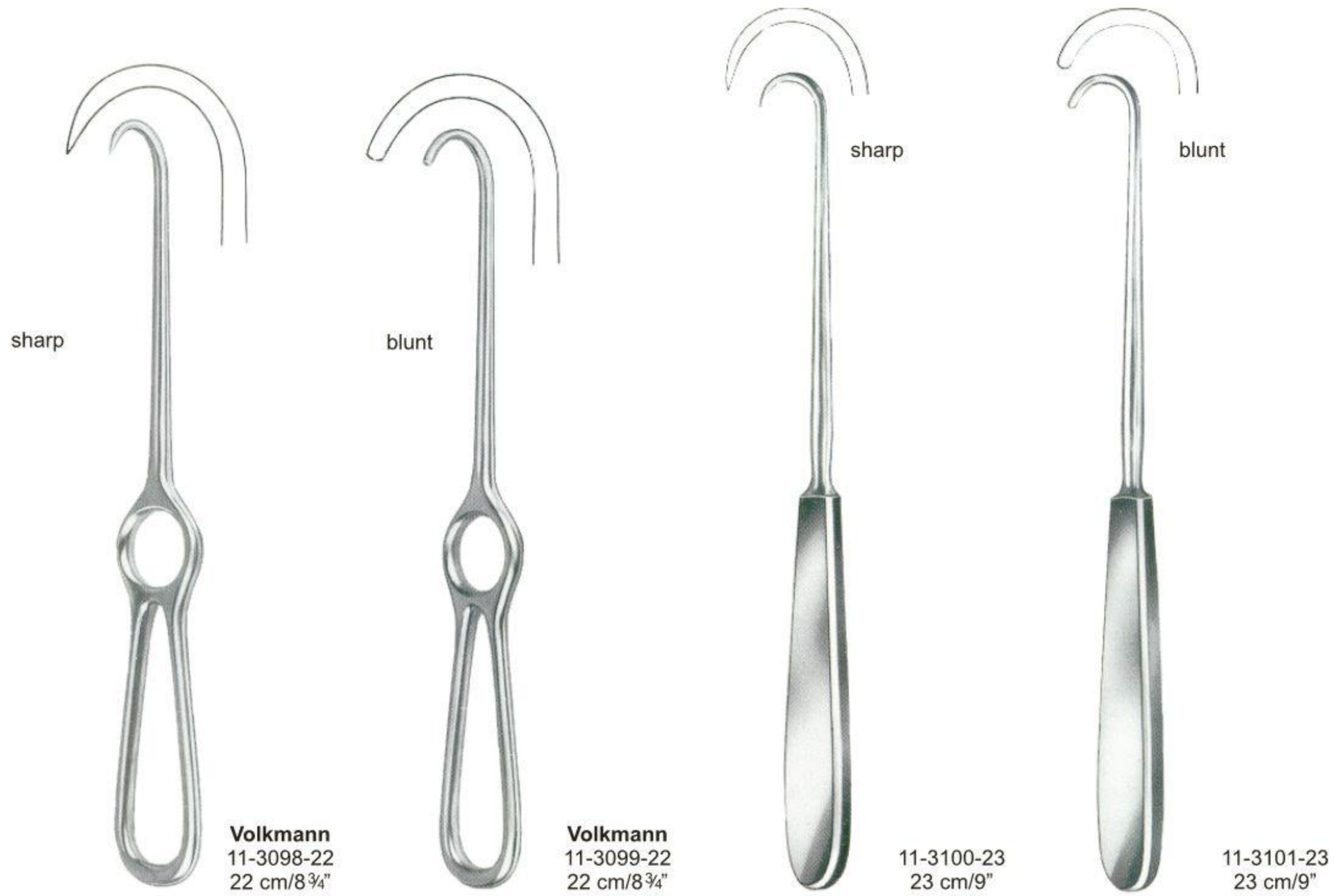

Retractors ●— EN
 Wundhaken ●— DE
 Separadores ●— ES



Volkmann
 23 cm/9"

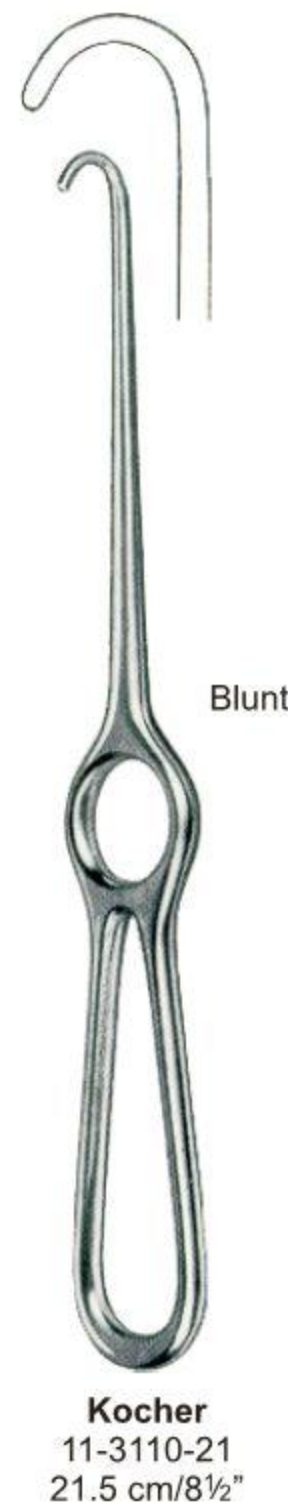
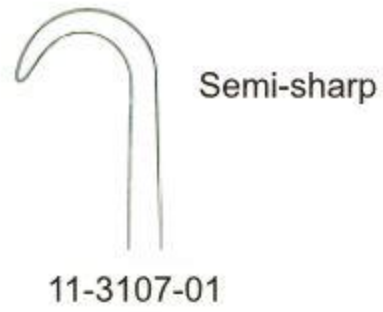



Kocher
21.5cm/8½"



sharp
11-3116-20
20 cm/8"



blunt
11-3117-20
20 cm/8"

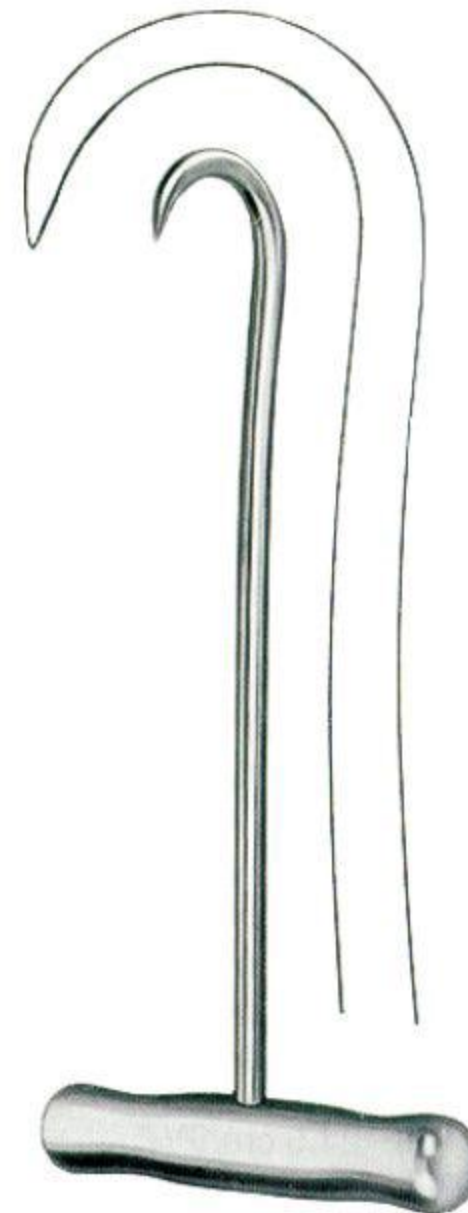

sharp
11-3118-14
14 cm/5½"



11-3119-03
 36x30 mm



11-3120-04
 36x60 mm

Ollier
 22.5 cm/9"



Murphy
 19.5 cm/7 3/4"

Sharp



11-31121-02



11-3121-03



11-3121-04



11-3121-06

blunt



11-3122-02



11-3122-03



11-3122-04



11-3122-06



Wassmund
11-3123-20
20cm/8"



11-3124-02
40x50 mm

Israel
25cm/10"



11-3124-01
40x40 mm



11-3124-03
50x60 mm



11-3124-04
70x70 mm

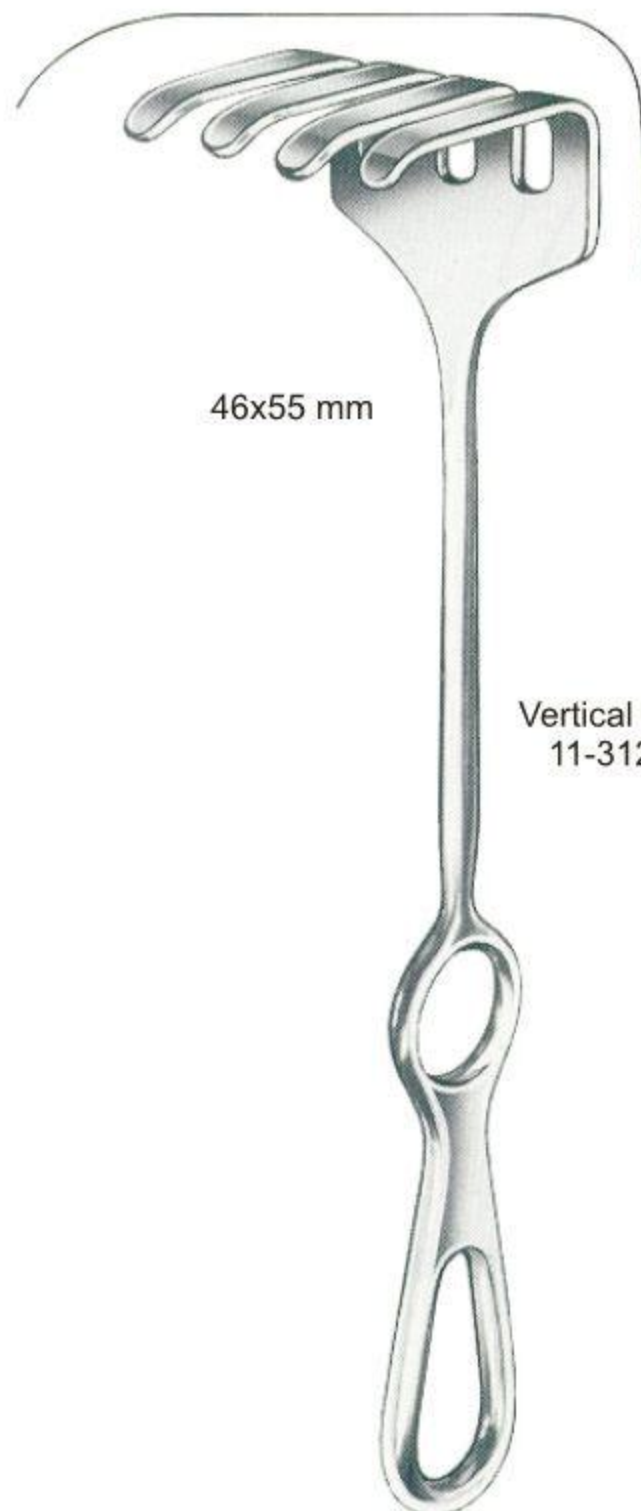

46x55 mm

Vertical Handle
11-3125-23

Koerte
23cm/9"

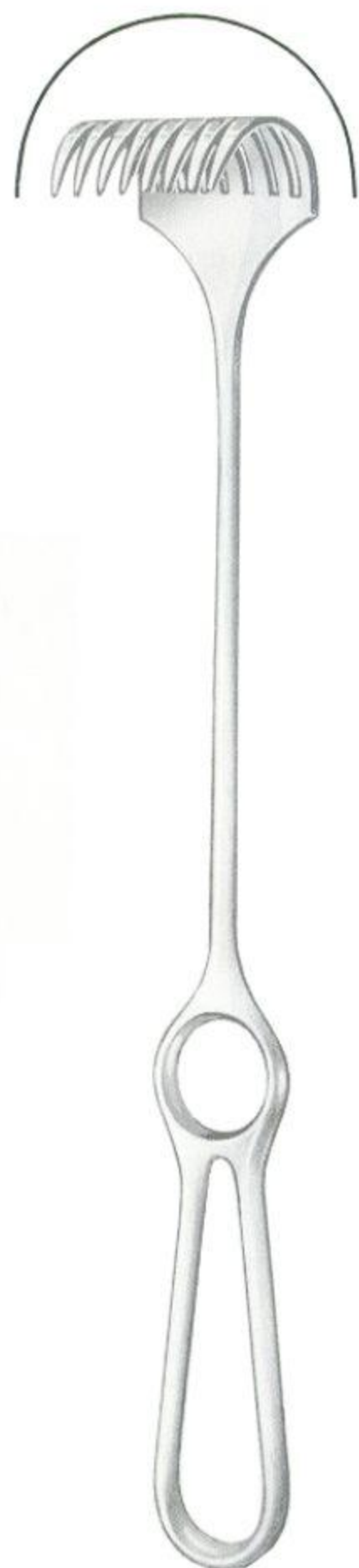

Koerte-Wagner
 11-3126-28
 28cm/11"



Koerte
 24cm/9½"

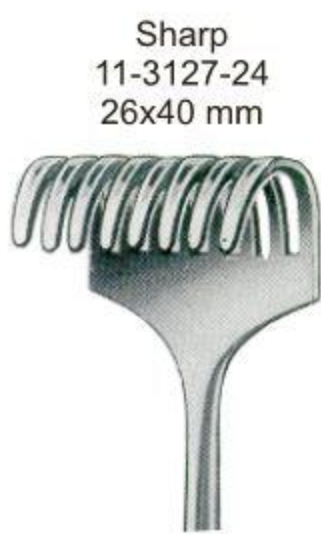

Blunt
 11-3128-24
 26x40 mm



11-3129-24
 24cm/9½"



11-3130-25
 25cm/10"





38x20 mm

Kocher
 11-3138-22
 22cm/8¾"

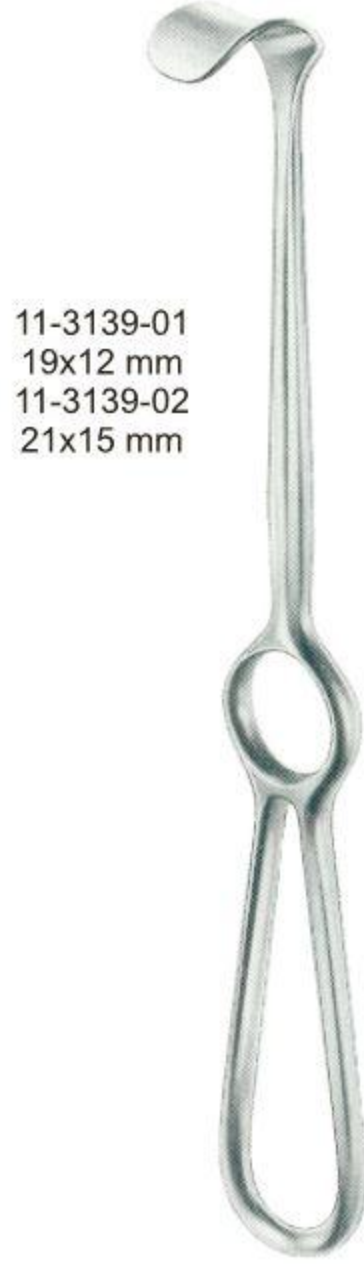

11-3139-01
 19x12 mm
 11-3139-02
 21x15 mm

Kocher
 19cm/7½"

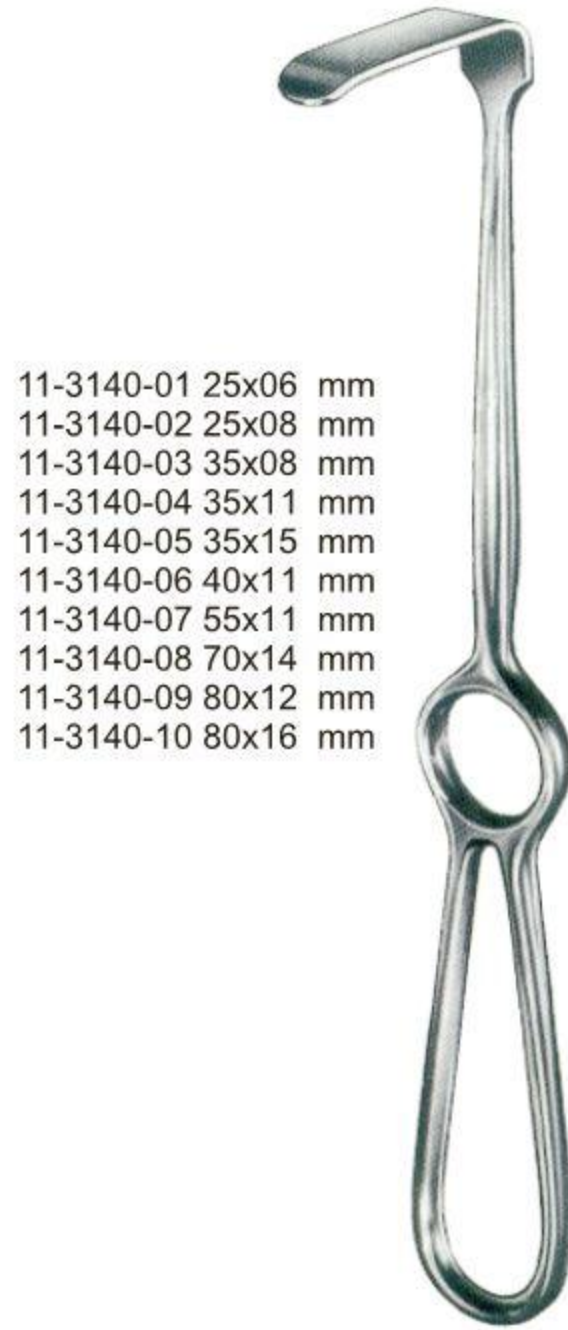

11-3140-01 25x06 mm
 11-3140-02 25x08 mm
 11-3140-03 35x08 mm
 11-3140-04 35x11 mm
 11-3140-05 35x15 mm
 11-3140-06 40x11 mm
 11-3140-07 55x11 mm
 11-3140-08 70x14 mm
 11-3140-09 80x12 mm
 11-3140-10 80x16 mm

Kocher-Langenbeck
 21.5cm/8½"



67x17cm

Casper
 11-3141-21
 21.5cm/8½"

11-3143-01
22x15 mm

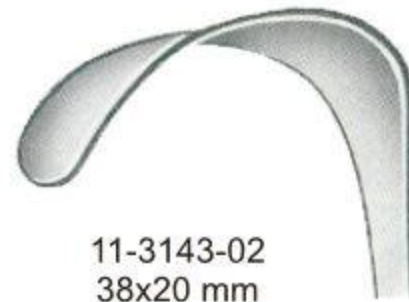

11-3143-02
38x20 mm

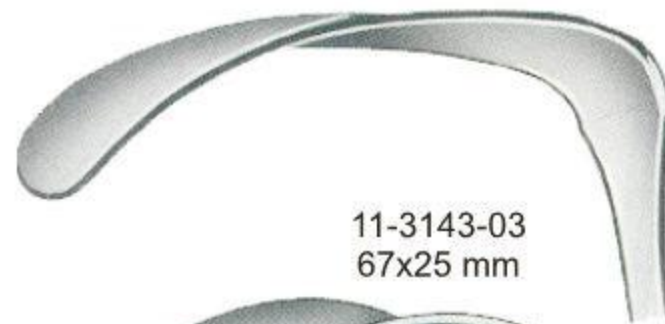

11-3143-03
67x25 mm



11-3143-04
100x35 mm



11-3142-01
40x18 mm
11-3142-02
60x20 mm
11-3142-03
60x25 mm
11-3142-04
75x30 mm
11-3142-05
75x40 mm

Kocher
23cm/9"



Kocher-Wagner
28cm/11"



11-3144-01
60x20 mm
11-3144-02
80x30 mm
11-3144-03
100x30 mm
11-3144-04
120x30 mm
11-3144-05
140x30 mm
11-3144-06
140x40 mm

Heosel
25cm/10"



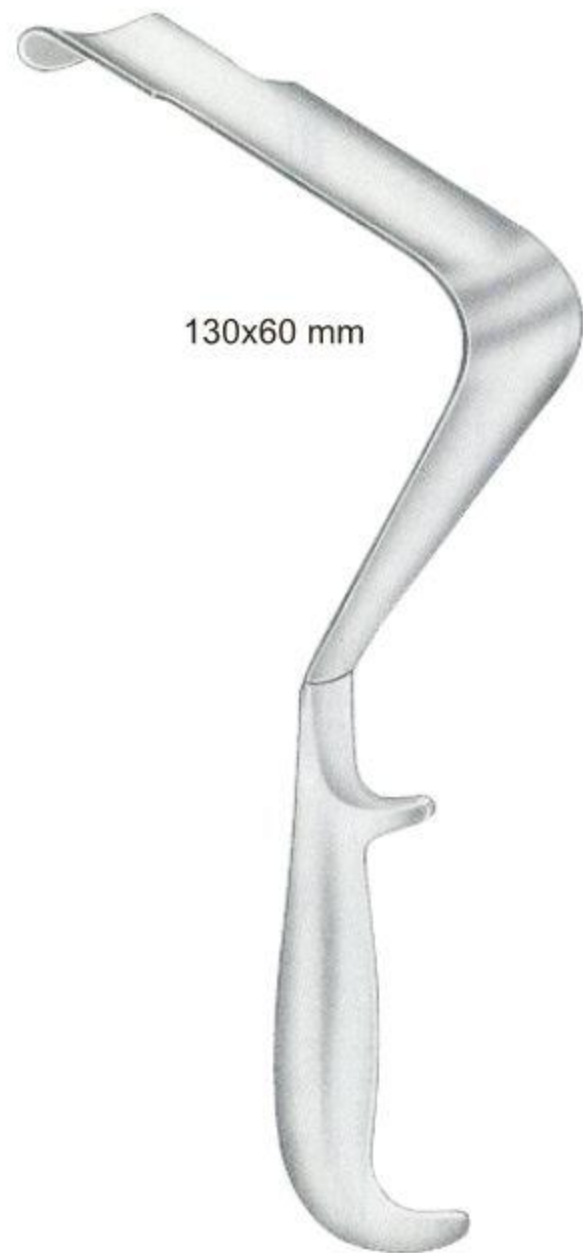

130x60 mm

St. Marks
 11-3145-29
 29cm/11½"

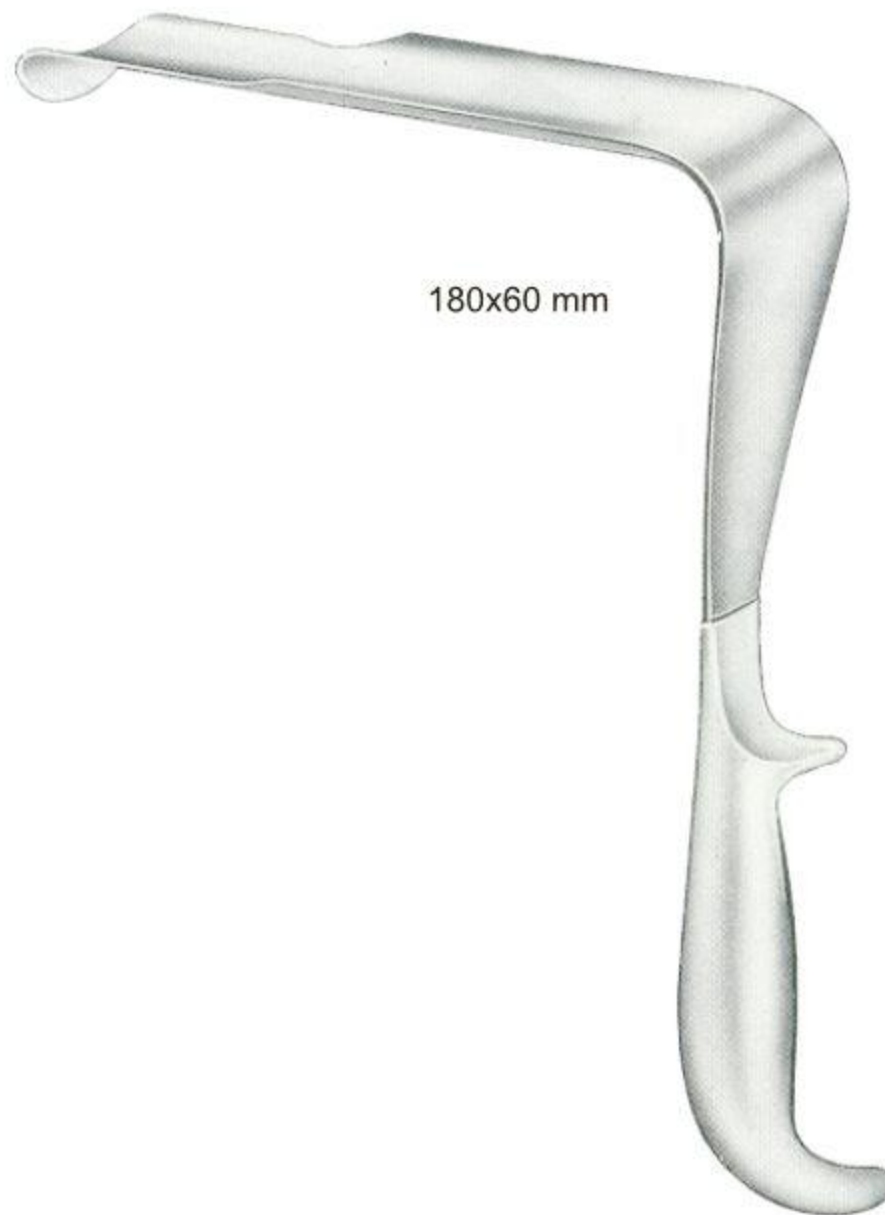

180x60 mm

St. Marks
 11-3146-32
 32.5cm/12¾"

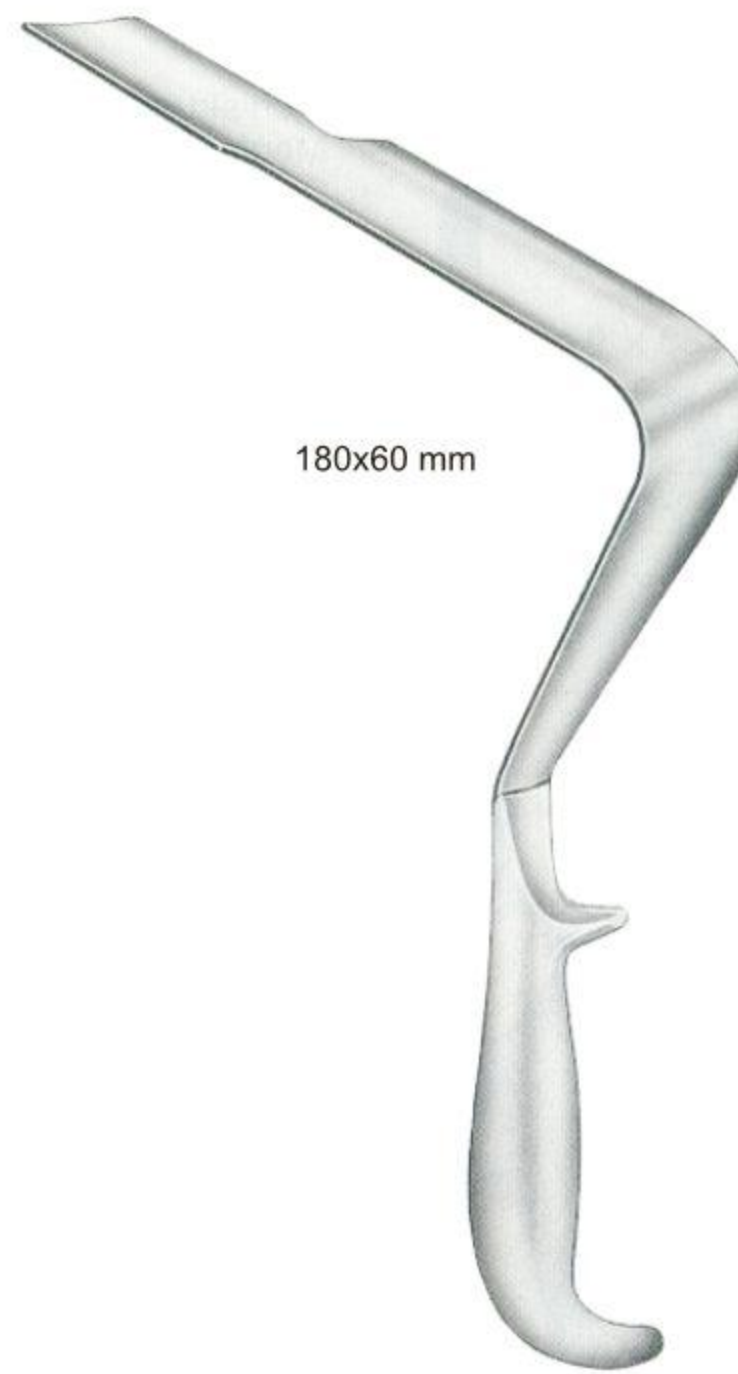

180x60 mm

St. Marks
 11-3147-33
 33cm/13"



- 11-3148-01
70x40 mm
- 11-3148-02
70x50 mm
- 11-3148-03
70x65 mm

Morris
 21cm/8¼"



- 11-3149-01
32x50 mm/38x50mm
- 11-3149-02
45x50 mm/50x50mm
- 11-3149-03
65x50 mm/38x50mm

Morris
 24cm/9½"

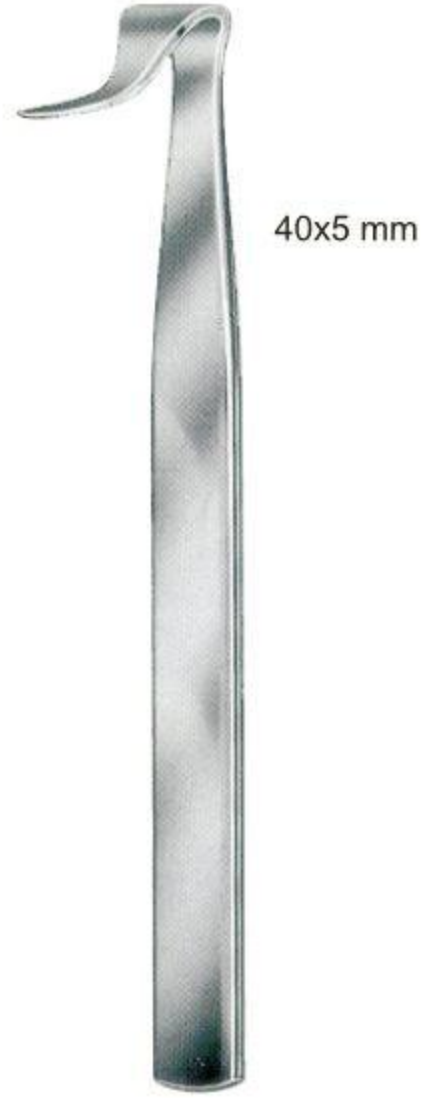

11-3153-01



11-3153-02



11-3153-03



11-3154-01



11-3154-02



11-3154-03



Middeldorpf



11-3155-01
 45x45 mm

Middeldorpf
 25.5cm/10"

- 11-3155-01
 45x45 mm
- 11-3155-02
 45x50 mm
- 11-3155-03
 55x70 mm



Richardson
 26cm/10¼"



11-3156-01
 28x20 mm

11-3156-02
 30x28 mm

11-3156-03
 38x37 mm

11-3156-04
 52x22 mm

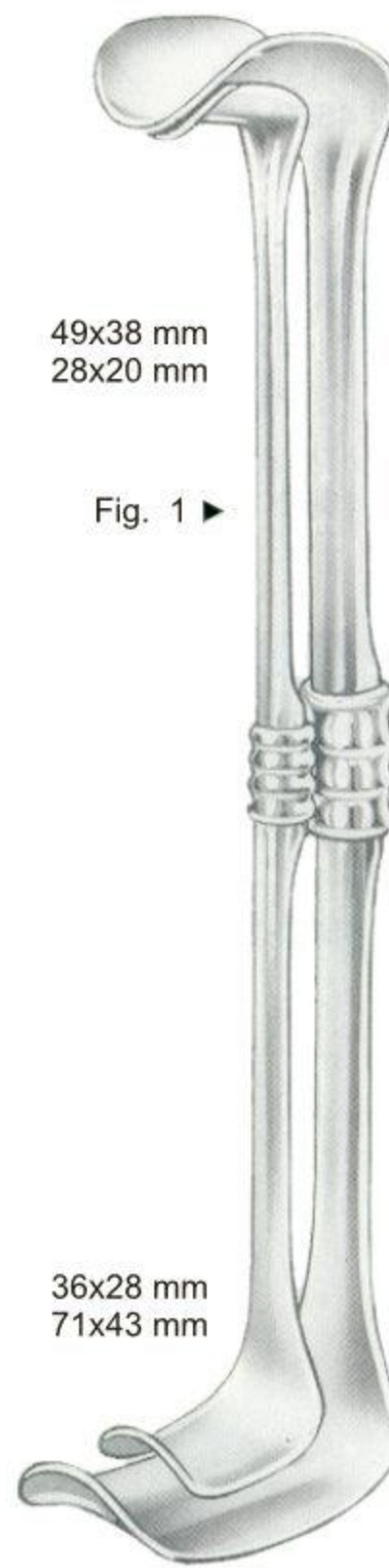

49x38 mm
 28x20 mm

Fig. 1 ▶

◀ Fig. 2

36x28 mm
 71x43 mm

Richardson-Eastman

Set 11-3157-00

Fig. 1
 26cm/10¼" 11-3157-01

Fig. 2
 28cm/11" 11-3157-02



Kelly
 26cm/10¼"

- 11-3158-01
 40x50 mm
- 11-3158-02
 50x65 mm
- 11-3158-03
 65x75 mm
- 11-3158-04
 75x90 mm

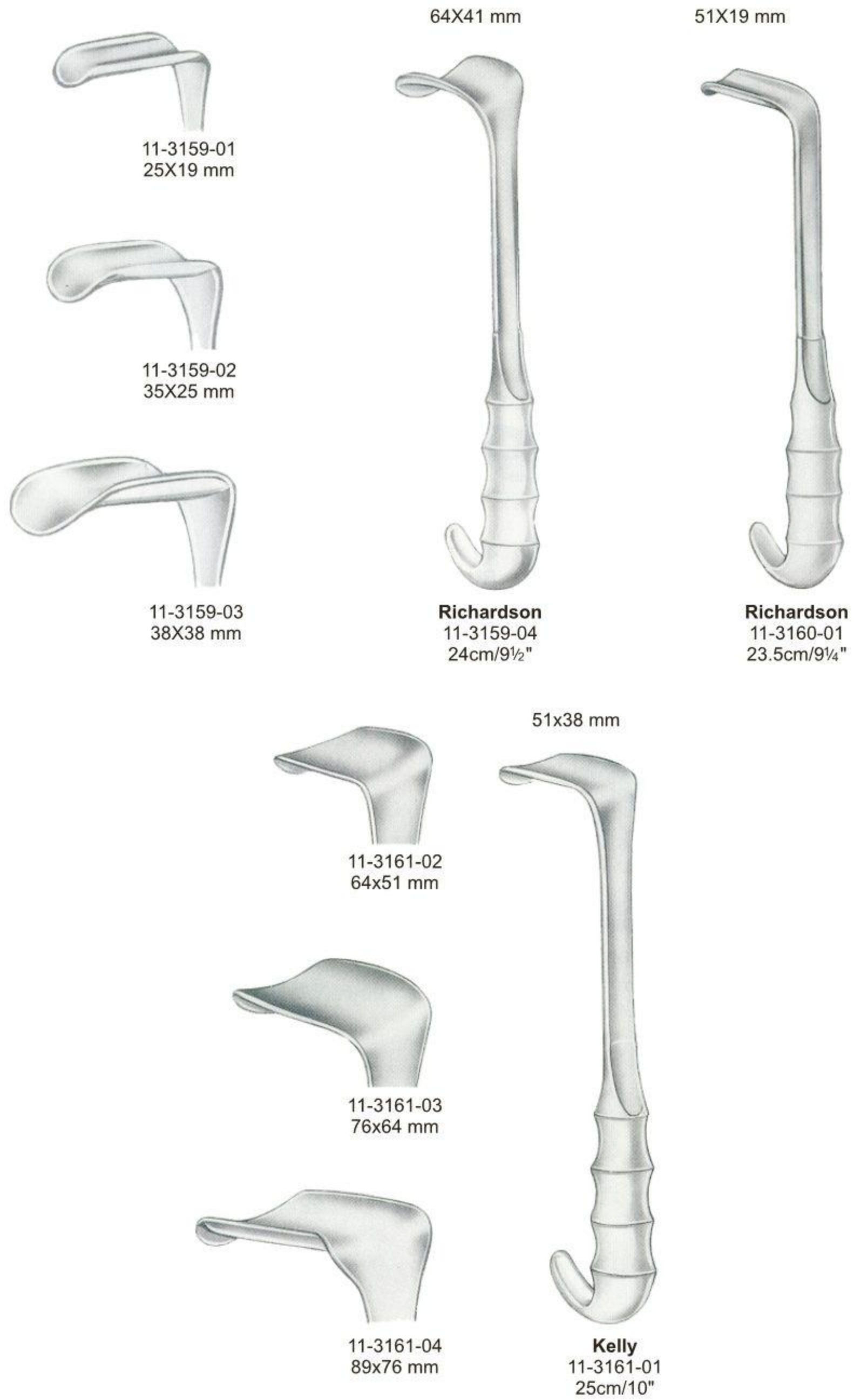

11-3162-01
 45x40 mm
 11-3162-02
 45x50 mm
 11-3162-03
 45x60 mm
 11-3162-04
 45x75 mm
 11-3162-05
 65x85 mm

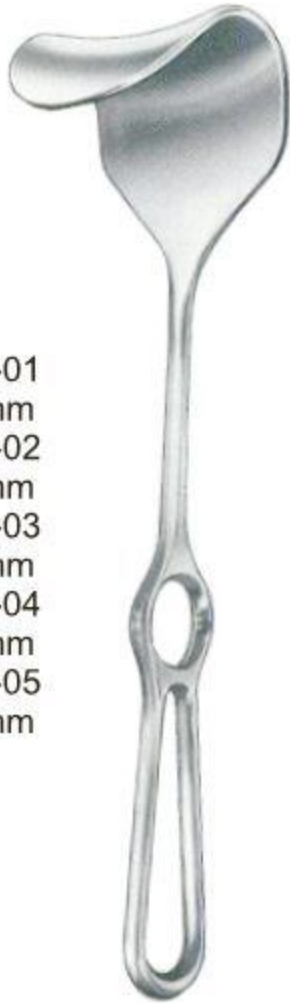

Fritsch
 24cm/9½"

50x85 mm

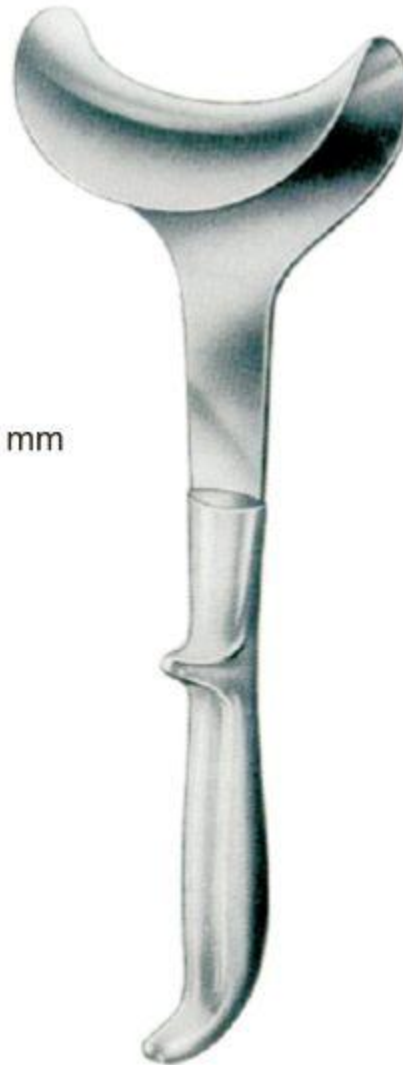

Doyen
 11-3163-25
 25cm/10"

11-3164-01
 15x90 mm
 11-3164-02
 20x90 mm
 11-3164-03
 30x90 mm
 11-3164-04
 35x110 mm
 11-3164-05
 40x110 mm
 11-3164-06
 55x120 mm

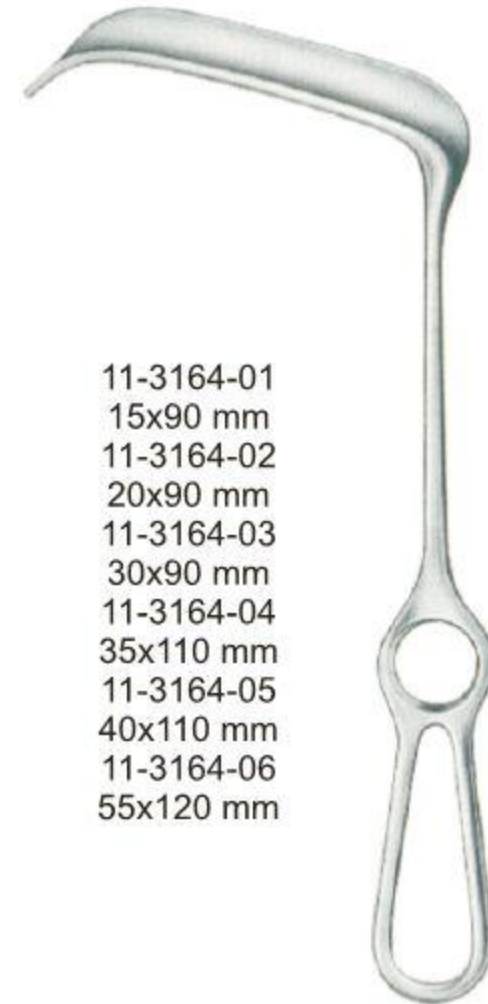

Doyen-Stille
 24cm/9½"

70x25 mm



Kocher
 11-3165-22
 22.5cm/9"

11-3166-01
 80x42 mm
 11-3166-02
 80x50 mm
 11-3166-03
 80x60 mm



Kocher
 25cm/10"

60x60 mm



Tuffier
 11-3167-23
 23cm/9"

11-3168-01
 115x22 mm



Simon
 28cm/11"

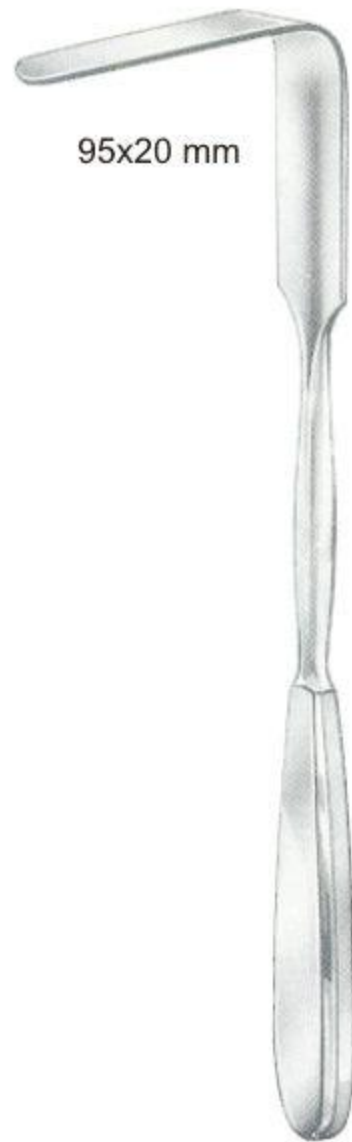

95x20 mm

Tuebingen
11-3169-28
28cm/11"



105x27 mm

Martin
11-3170-26
26cm/10¼"

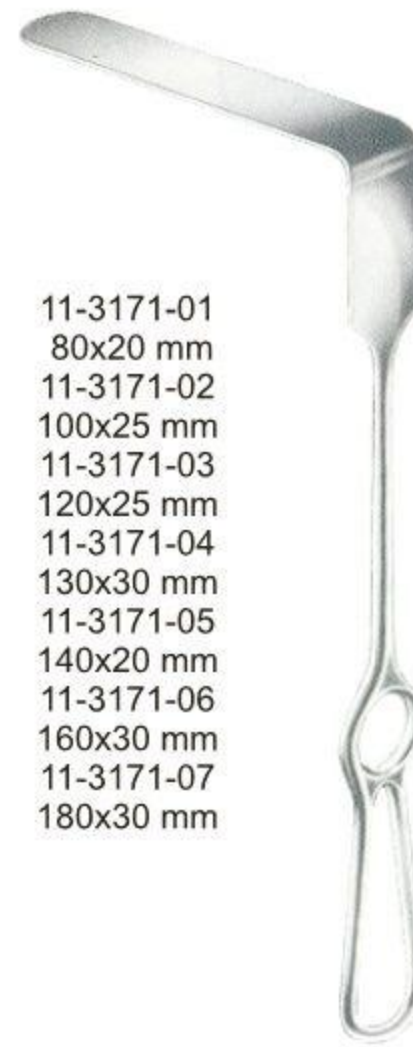

- 11-3171-01
80x20 mm
- 11-3171-02
100x25 mm
- 11-3171-03
120x25 mm
- 11-3171-04
130x30 mm
- 11-3171-05
140x20 mm
- 11-3171-06
160x30 mm
- 11-3171-07
180x30 mm

Brunner
25cm/10"

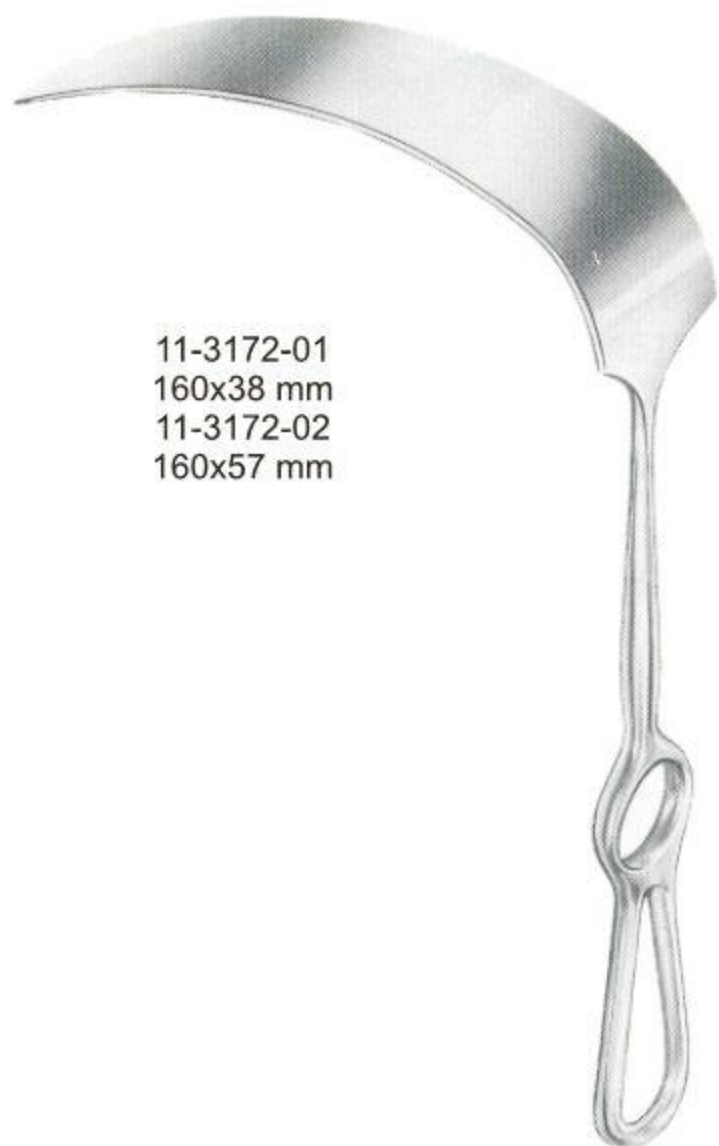

11-3172-01
 160x38 mm
 11-3172-02
 160x57 mm

Kelly
 27cm/10½"



Polloson
 11-3173-27
 27cm/10½"



Polloson
 11-3174-27
 27cm/10½"



11-3175-03
 115x65 mm

11-3175-02
 115x38 mm

11-3175-01
 82x20 mm

Coryllos
 23.0cm/9"



11-3175-25
 130x38 mm

Sauerbruch
 25cm/10"





11-3185-01
 50x16 mm
 11-3185-02
 75x25 mm
 11-3185-03
 90x50 mm

Meyerding
 22.5cm/9"



Zenker

11-3186-01 25cm/10" 35x08 mm
 11-3186-02 26cm10¼" 60x12 mm
 11-3186-03 27.5cm/10¾" 75x12 mm

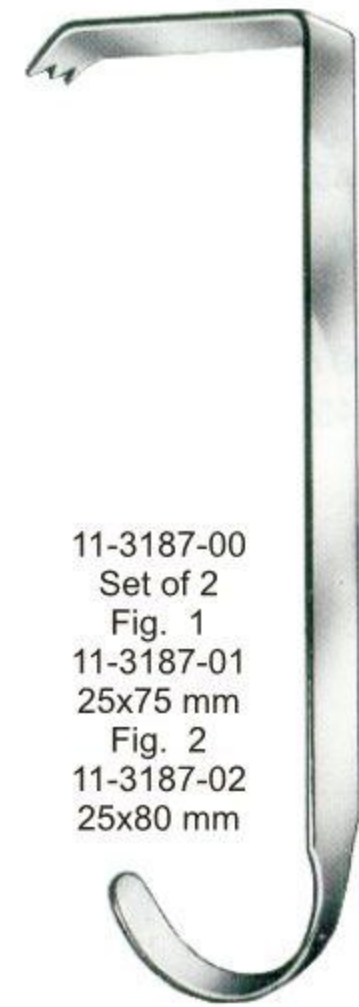

11-3187-00
 Set of 2
 Fig. 1
 11-3187-01
 25x75 mm
 Fig. 2
 11-3187-02
 25x80 mm

Hibbs
 24cm/9½"

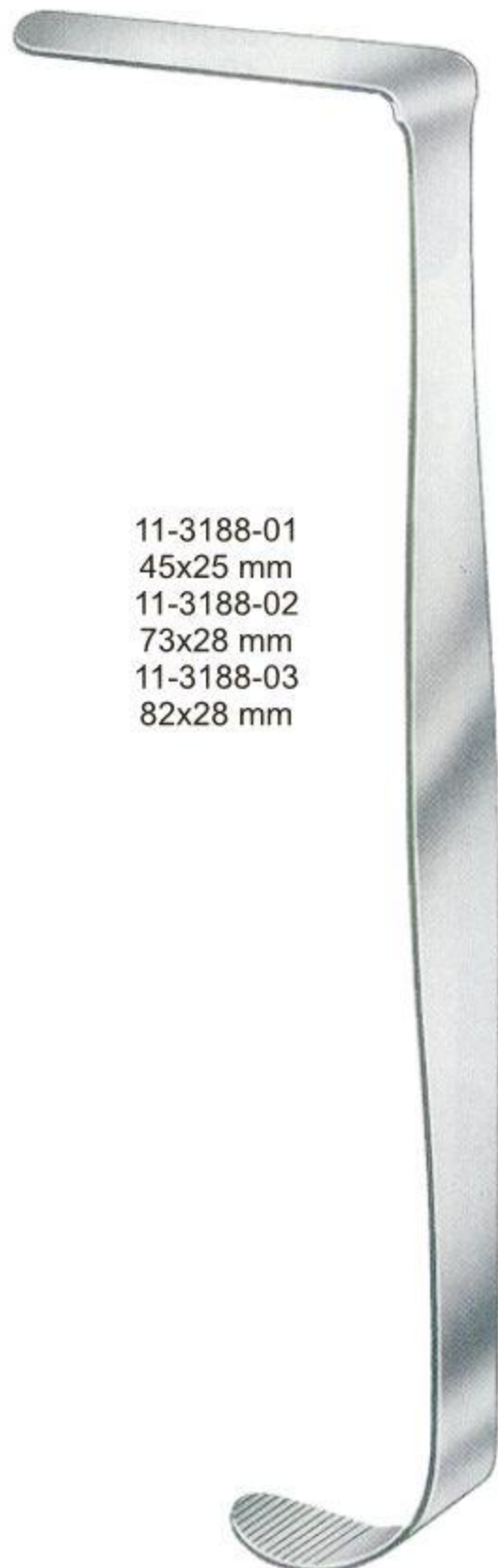

11-3188-01
 45x25 mm
 11-3188-02
 73x28 mm
 11-3188-03
 82x28 mm

Heaney
 27cm/10½"

46 mm



Kuemmel
 11-3189-33
 33cm/13"

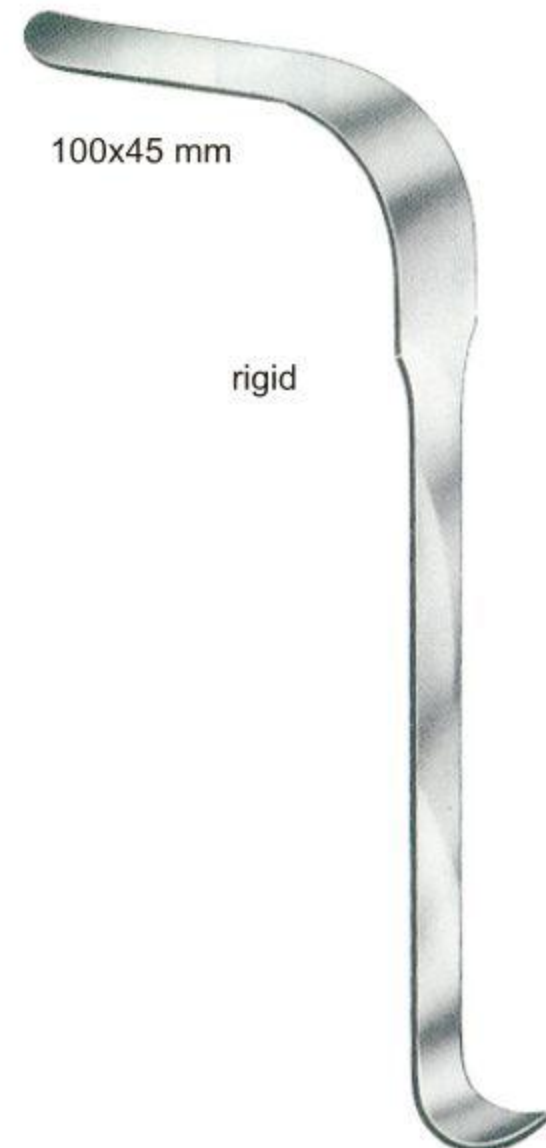

100x45 mm

rigid

Koerte
 11-3190-28
 28cm/11"

11-3191-20
20 mm
11-3191-30
30mm
11-3191-40
40 mm

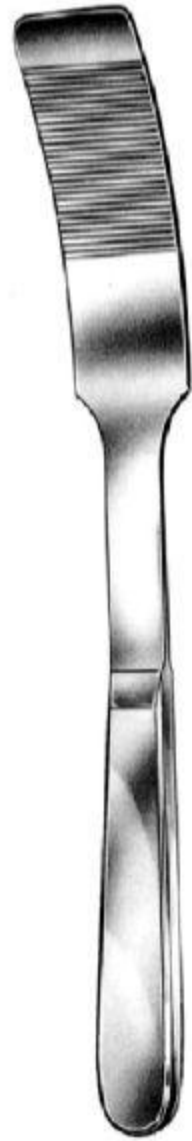

Kader
27cm/10½"



11-3192-01
25.5cm/10"
45 mm
11-3192-02
27.5cm/10¾"
60 mm

Leriche



Malleable
11-3193-01 20 mm
11-3193-02 25 mm
11-3193-03 30 mm
11-3193-04 35 mm
11-3193-05 40 mm
11-3193-06 45 mm
11-3193-07 50 mm
11-3193-08 64 mm
11-3193-09 76 mm
11-3193-10 102 mm
33cm/13"

Malleable



Tuffier
11-3194-20
20 cm/8"
17x25 mm

Malleable

11-3195-01
200x6 mm
11-3195-02
200x8 mm
11-3195-03
200x10 mm
11-3195-04
200x12 mm
11-3195-05
200x17 mm
11-3195-06
200x20 mm
11-3195-07
200x25 mm
11-3195-08
250x25 mm



20cm/8"

Malleable

11-3196-01
280x25/30 mm
11-3196-02
300x37/45 mm
11-3196-03
300x40/50 mm



Haberer
21cm/8¼"



Reverdin
11-3197-28
28 cm/11"



Davidson
 16cm/6¼"

75x50 mm
 75x90 mm

11-3198-01
 11-3198-02



Cooley
 11-3199-01
 21.5cm/8½"



Cooley
 11-3199-02
 21.5cm/8½"



Cooley
 11-3199-03
 23cm/9"



Ross
 27cm/10½"

- Fig. 1 11-3200-01 13x13 mm
- Fig. 2 11-3200-02 14x12 mm
- Fig. 3 11-3200-03 18x18 mm
- Fig. 4 11-3200-04 20x20 mm
- Fig. 5 11-3200-05 22x18 mm
- Fig. 6 11-3200-06 26x24 mm

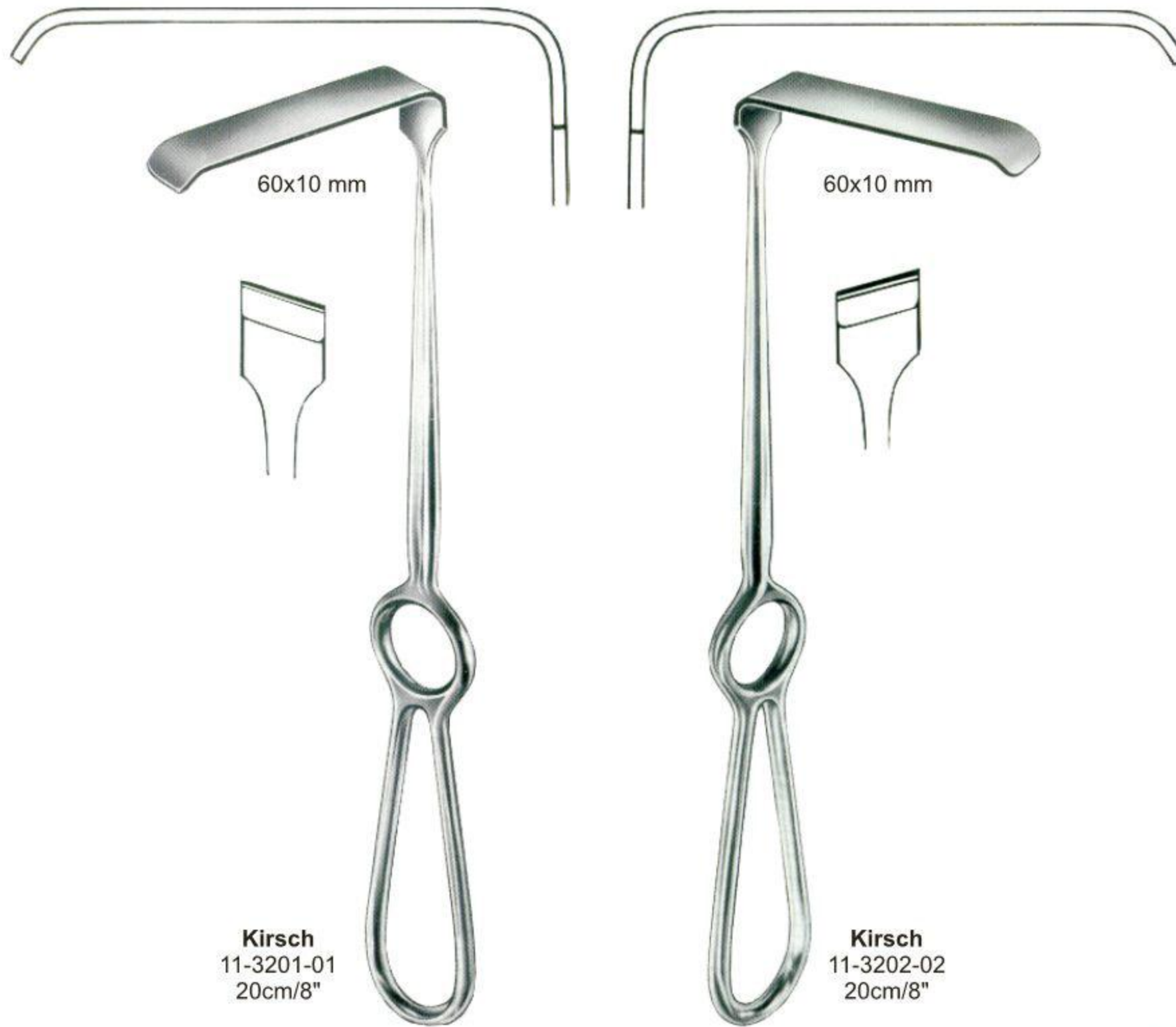

Retractors ● EN
 Wundhaken ● DE
 Separadores ● ES



22cm/8 $\frac{3}{4}$ "

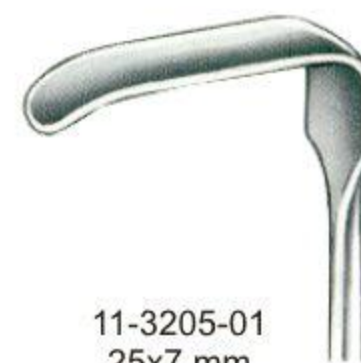

11-3205-01
25x7 mm

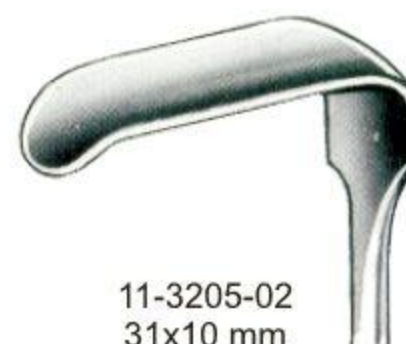

11-3205-02
31x10 mm



11-3205-03
42x11 mm



11-3205-04
55x12 mm



11-3205-05
70x14 mm



11-3205-06
80x18 mm



22cm/8¾"



11-3206-01
42x13 mm



11-3206-02
60x12 mm



11-3206-03
80x16 mm

Retractors ● EN
 Wundhaken ● DE
 Separadores ● ES



Spina-Nasalis
 11-3207-01
 22 cm/8³/₄"

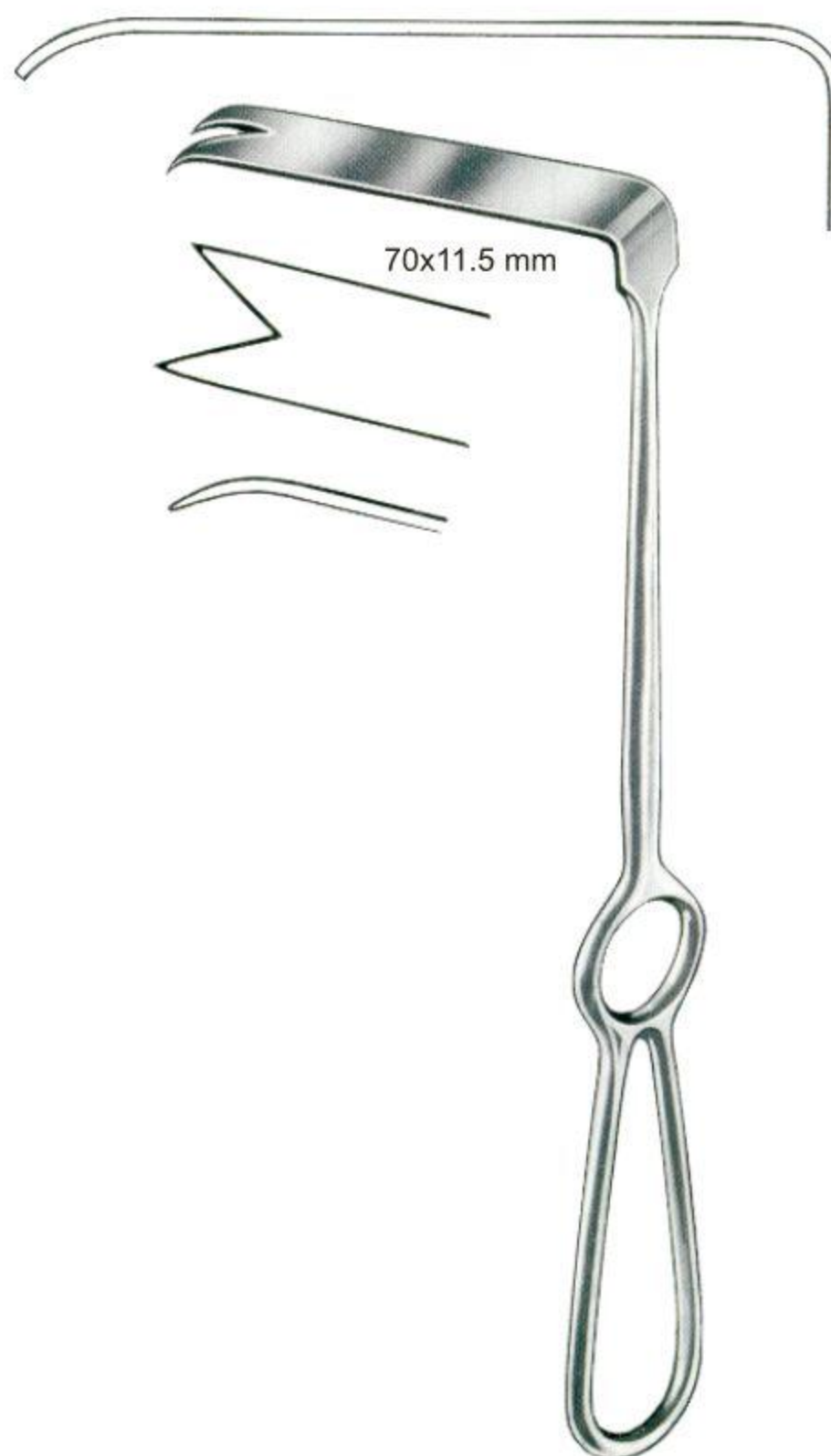

Ramus
 11-3208-02
 22 cm/8³/₄"



11-3209-15
 15.5 cm/6"



11-3210-16
 16 cm/6¹/₄"

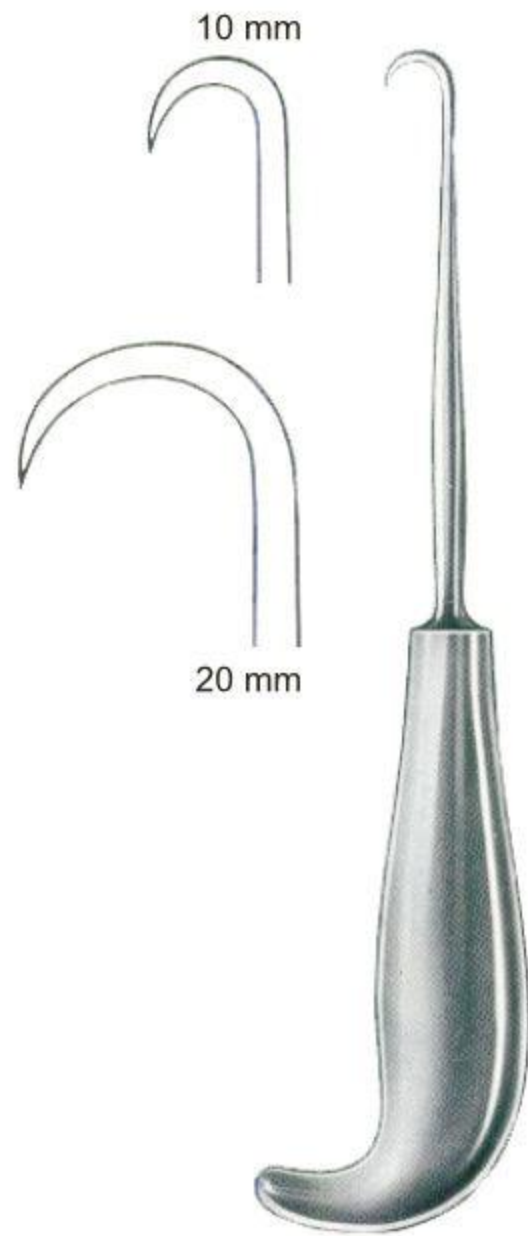

11-3211-10 10 mm
11-3211-20 20 mm
19cm/7½"



Dingman
11-3212-17
17.5cm/7"



Soeresen-Hein
11-3213-17
17.5cm/7"



Dingman
11-3214-21
21cm/8¼"



11-3215-18
18.5cm/7¼"

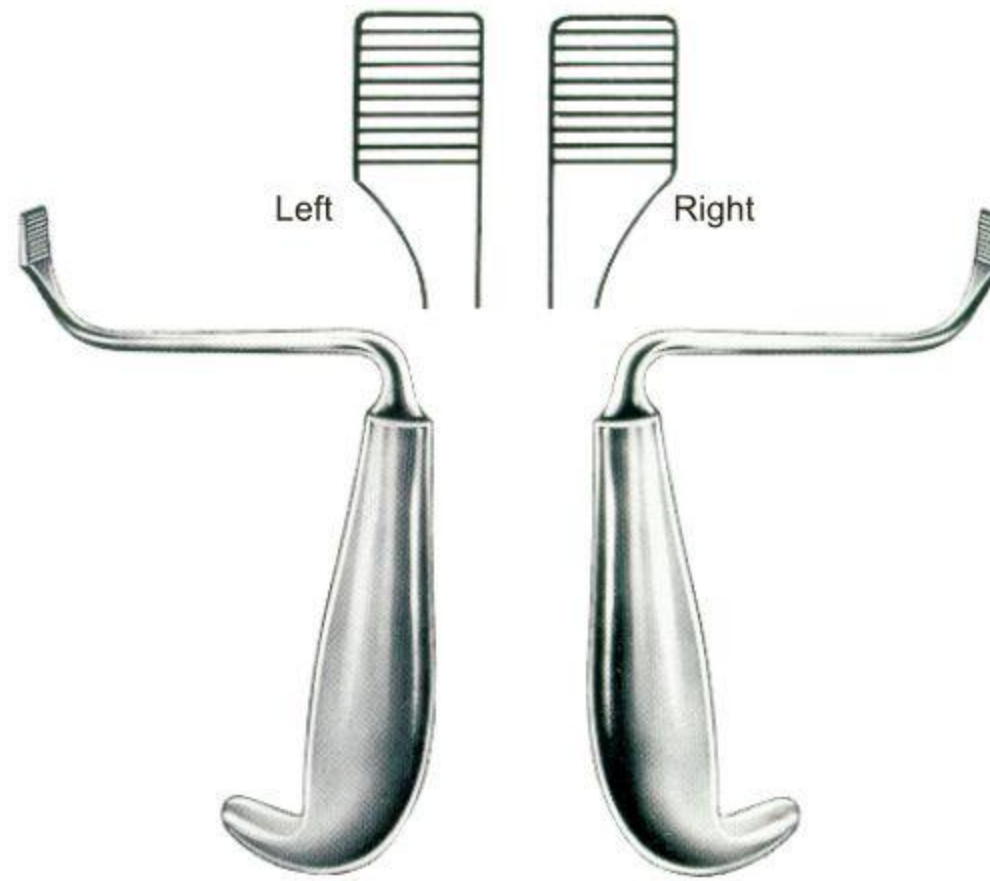

Tessier
11-3216-01
15cm/6"

Tessier
11-3217-02
15cm/6"



Dingman
11-3218-00



11-3219-21
 21cm/8¼"



11-3220-20
 20.5cm/8"



11-3221-17
 17.5cm/7"

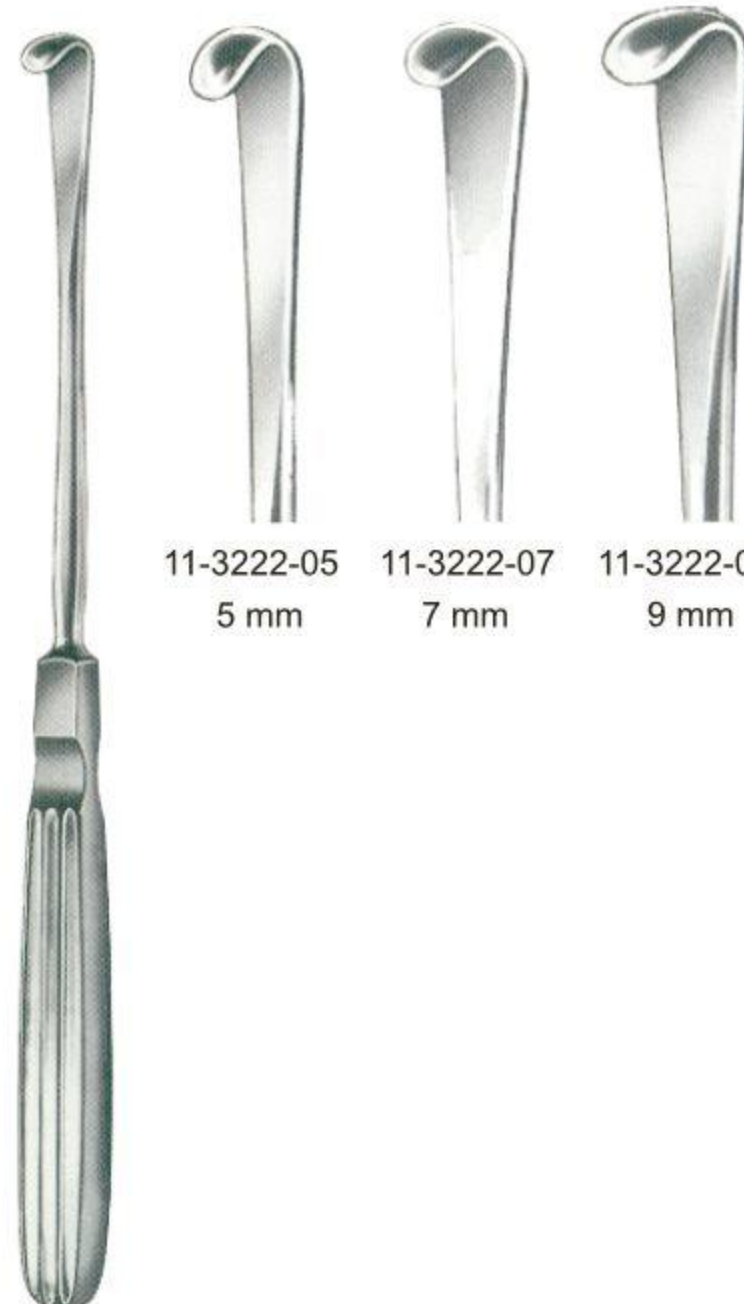

11-3222-05
 5 mm

11-3222-07
 7 mm

11-3222-09
 9 mm

20cm/8"



17.5cm/7"



11-3223-06
 6 mm



11-3223-07
 7 mm



11-3223-09
 9 mm



11-3223-11
 11 mm

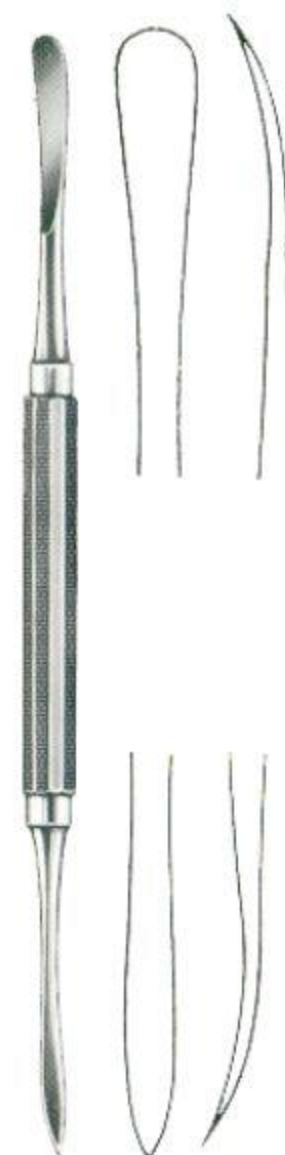

Dingman
 11-3224-18
 18cm/7"



11-3225-23
 23.5cm/9¼"
 10 mm



Tessier
20.5cm/8"



11-3226-10
10 mm



11-3227-10
10 mm



11-3228-01
18.5cm/7¼"

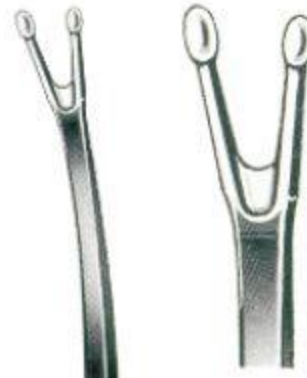

11-3229-02
18.5cm/7¼"



11-3230-07
7 mm
21.5cm/8½"



11-3231-10
10 mm
21.5cm/8½"



15cm/6"



11-3232-02
2.5 mm



11-3232-04
4 mm



Bowdler-Henry's
11-3233-16
16.5cm/6½"



Gillies
11-3234-21
21cm/8¼"



Gillies
11-3235-21
21cm/8¼"

Retractors ●— EN
 Wundhaken ●— DE
 Separadores ●— ES



Sanders-Brown
 11-3236-30
 30cm/12"



Sanders-Brown
 11-3237-29
 29cm/11½"



11-3238-14
 14cm/5½"



11-3239-23
 23cm/9"



11-3240-18
 18cm/7"



Kelsey-Fry
 11-3241-15
 15cm/6"



Kelsey-Fry
 11-3242-18
 18cm/7"



Mershon
 11-3243-14
 14.5cm/5½"



Bose



Finsen



Finsen

cm	in		Sharp	Blunt	Sharp
5	2		11-3245-05	11-3246-05	
7	2¾"	11-3244-07	11-3245-07	11-3246-07	11-3247-07



Allport
11-3248-09
9.5cm/3¾"



Alm

cm	in		Sharp	Blunt
8.5	3½"	11-3248-08	11-3249-07	11-3250-07
11.5	4½"	11-3248-11	11-3249-10	11-3250-10



Holzheimer
 Sharp 11-3251-10 10 cm/4"
 blunt 11-3252-10



Jansen
 Sharp 11-3253-10 10.5 cm/4¼"
 blunt 11-3254-10



Jansen-Deep
 Sharp 11-3255-10 10.5 cm/4¼"
 blunt 11-3256-10



Plester
 11-3257-11
 11.5 cm/4½"



Plester
 11-3258-11
 11.5 cm/4½"



Plester
 Sharp 11-3259-13 13 cm/5"
 blunt 11-3260-13

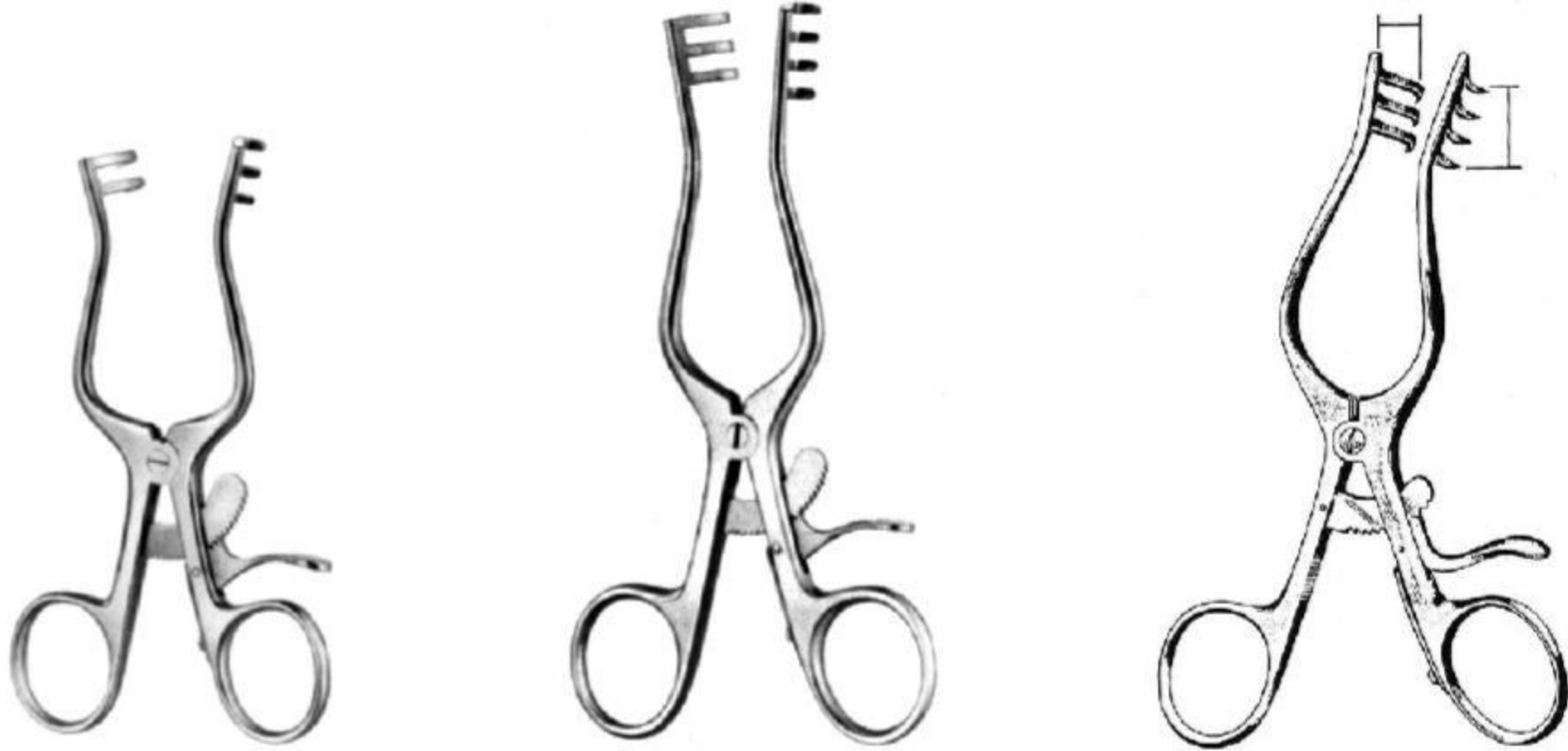

	Weitlaner		Weitlaner		Weitlaner-Wullstein	
	Sharp	Blunt	Sharp	Blunt	Sharp	Blunt
10.5 cm/4¼"	11-3261-10	11-3262-10				
13.0 cm/5"	11-3261-13	11-3262-13	11-3263-13	11-3264-13	11-3265-13	11-3266-13
14.0 cm/5½"	11-3261-14	11-3262-14	11-3263-14	11-3264-14	11-3265-14	11-3266-14
16.5 cm/6½"	11-3261-16	11-3262-16	11-3263-16	11-3264-16	11-3265-16	11-3266-16



Mollison
11-3267-15
15 cm/6"



Tuebinger-Modell
11-3268-16
16 cm/6¼"



Henner(Lempert)
11-3269-12
12 cm/4½"

Complete with 2 pairs of blades and centre blade

Complete with 3 Central blades



Henley

Sharp 11-3270-16 16.5 cm/6½"
 Blunt 11-3271-16

Central blades, only



11-3272-19 11-3272-25 11-3272-32
 16x19 mm 16x25 mm 16x32 mm

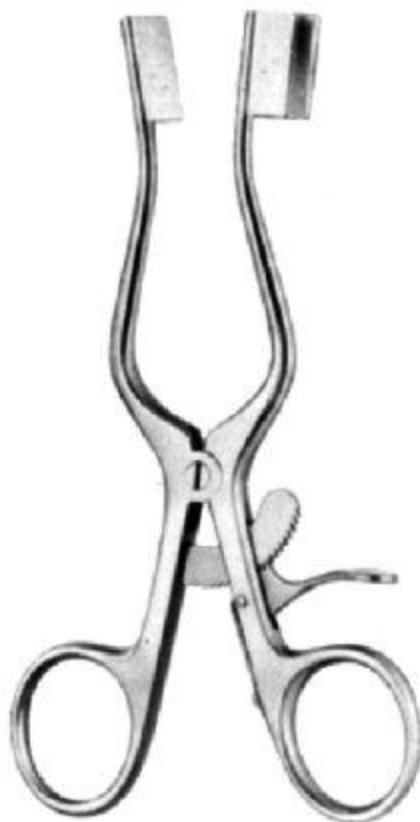

Weitlaner-Baby

13 cm/5"
 16 cm/6¼" 11-3273-13



Milligan

Sharp 11-3274-13 Blunt 11-3275-13



Cone (Adson-Baby)

Sharp 11-3276-13 Blunt 11-3277-13
 11-3276-16 11-3277-16



Weitlaner

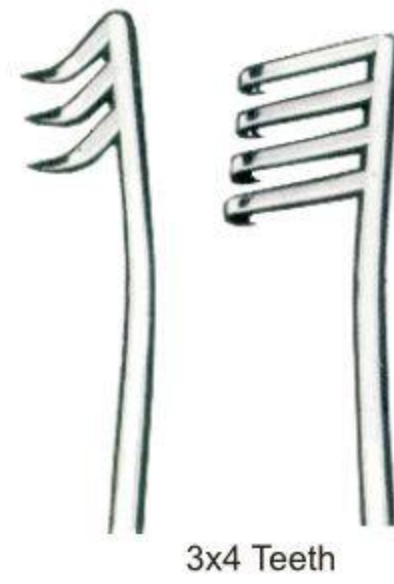

3x4 Teeth

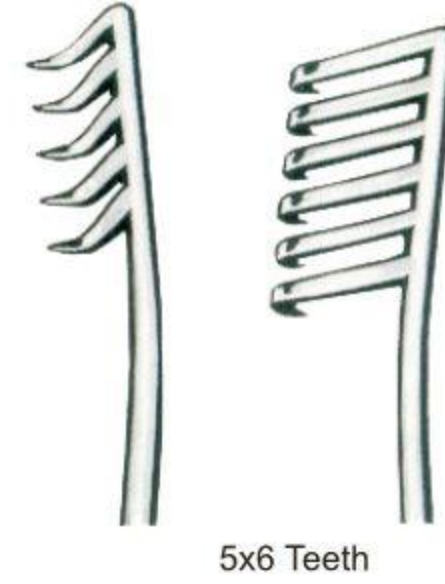

5x6 Teeth

	Sharp	Blunt	Sharp	Blunt
20 cm/8"	11-3278-20	11-3279-20		
25 cm/10"	11-3278-25	11-3279-25	11-3280-25	11-3281-25



Adson

	Sharp	Blunt
20 cm/8"	11-3282-20	11-3283-20
26 cm/10¼"	11-3282-26	11-3283-26



Anderson-Adson

	Sharp	Blunt
	11-3284-20	11-3285-20



Cone

	Sharp	Blunt
	11-3286-20	11-3287-20
	11-3286-26	11-3287-26



Travers
 11-3288-21
 21 cm/8¼"

Jaws Depth

	Beckmann-Adson 31 cm/12¼"		Adson 27 cm/10½"	
	Sharp	Blunt	Sharp	Blunt
25 mm	11-3289-01	11-3290-01	11-3291-27	11-3292-27
44 mm	11-3289-02	11-3290-02		

5x6 Teeth



Adson
Sharp 11-3293-27 27cm/10½"
Blunt 11-3294-27



Beckmann-Adson (Standard)
Sharp 11-3295-31 31cm/12¼"
Blunt 11-3296-31



Adson
11-3297-33 33cm/13"

Hemilaminectomy Retractor



11-3298-27
 27cm/10½"



Beckmann-Eaton
 11-3299-33
 33 cm/13"

Retractor Only 11-3300-01 Lateral Blades 11-3300-02

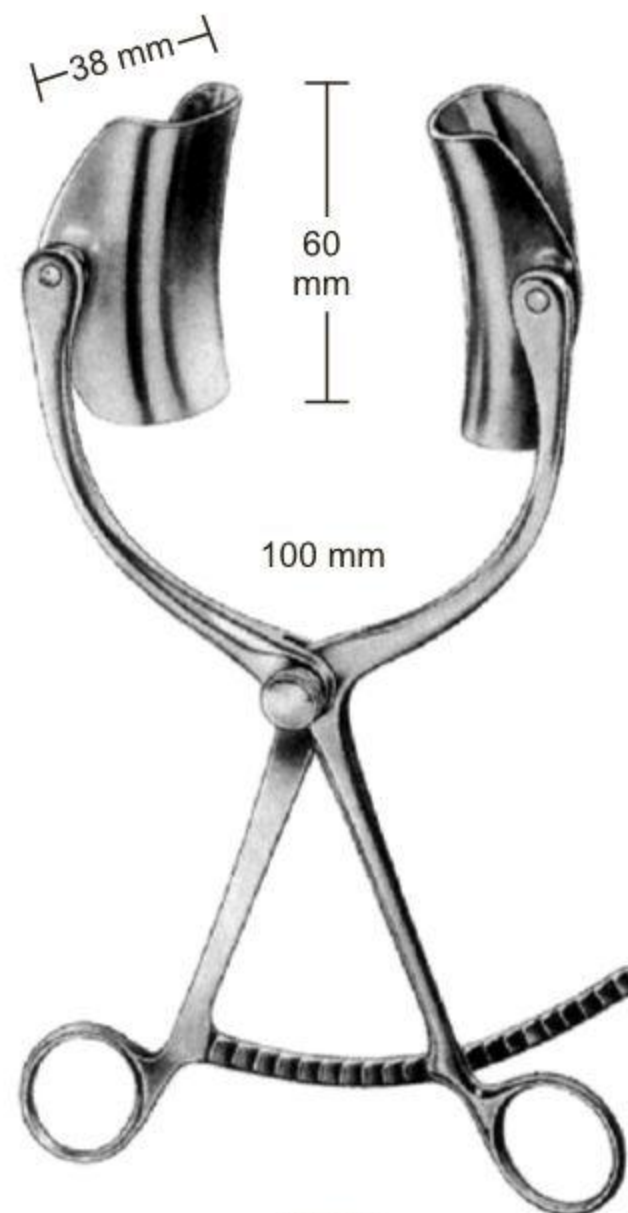

Collin
 11-3300-00
 20cm/8"

EN —● Ophthalmologie. Ophthamology, Oftalmoloia
 DE —● Keratoplastikmesser, Stanzen Meibel
 ES —● Keratoplastikmesser, Stanzen Meibel

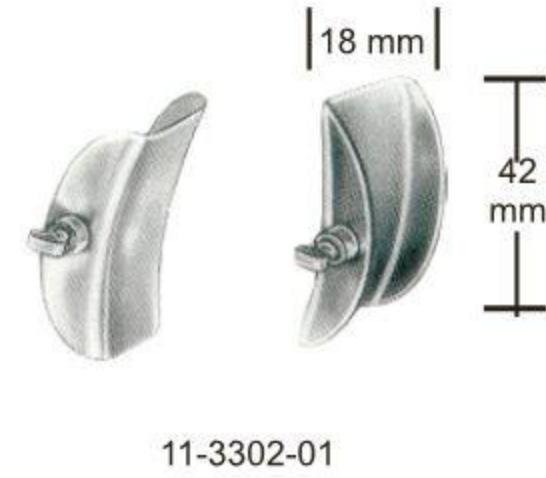
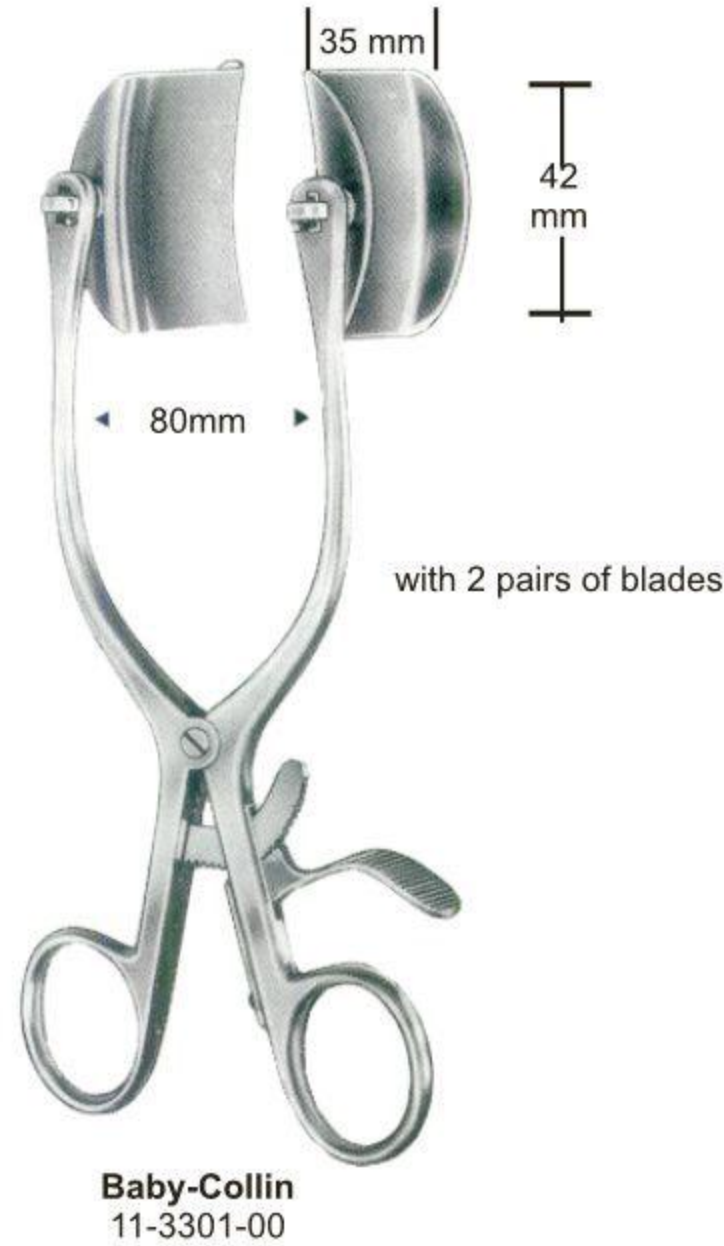
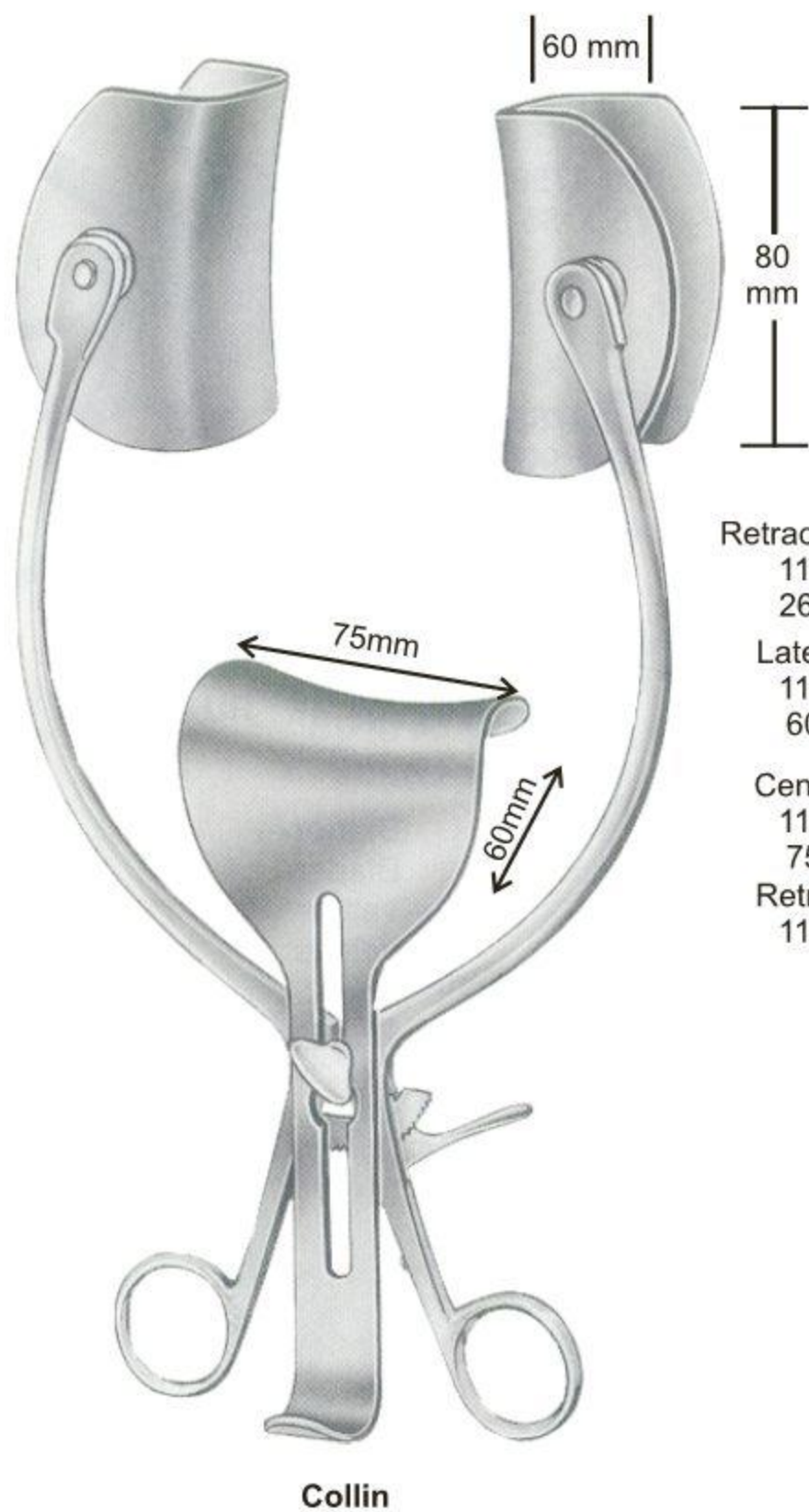

	Fig. 1 11-3303-00	Fig. 2 11-3304-00	Fig. 3 11-3305-00
Retractors Complete	11-3303-00	11-3304-00	11-3305-00
Retractors Only	11-3303-01	11-3304-01	11-3305-01
Lateral Blades	11-3303-02 38x62 mm	11-3304-02 38x80 mm	11-3305-02 38x100 mm
Central Blades	11-3303-03 55x55 mm		11-3305-03 55x75 mm

Ophthalmologie. Ophthalmology, Oftalmoloia ●— EN
 Keratoplastikmesser, Stanzen Meibel ●— DE
 Keratoplastikmesser, Stanzen Meibel ●— ES



Retractor Complete
 11-3306-00
 26cm/10½"
 Lateral Blades
 11-3306-01
 60X80mm
 Central Blades
 11-3306-02
 75X60mm
 Retractor Only
 11-3306-03



Mayo-Adams
 11-3307-01
 17cm/6¾"



Mayo-Adams
 11-3307-02
 17cm/6¾"

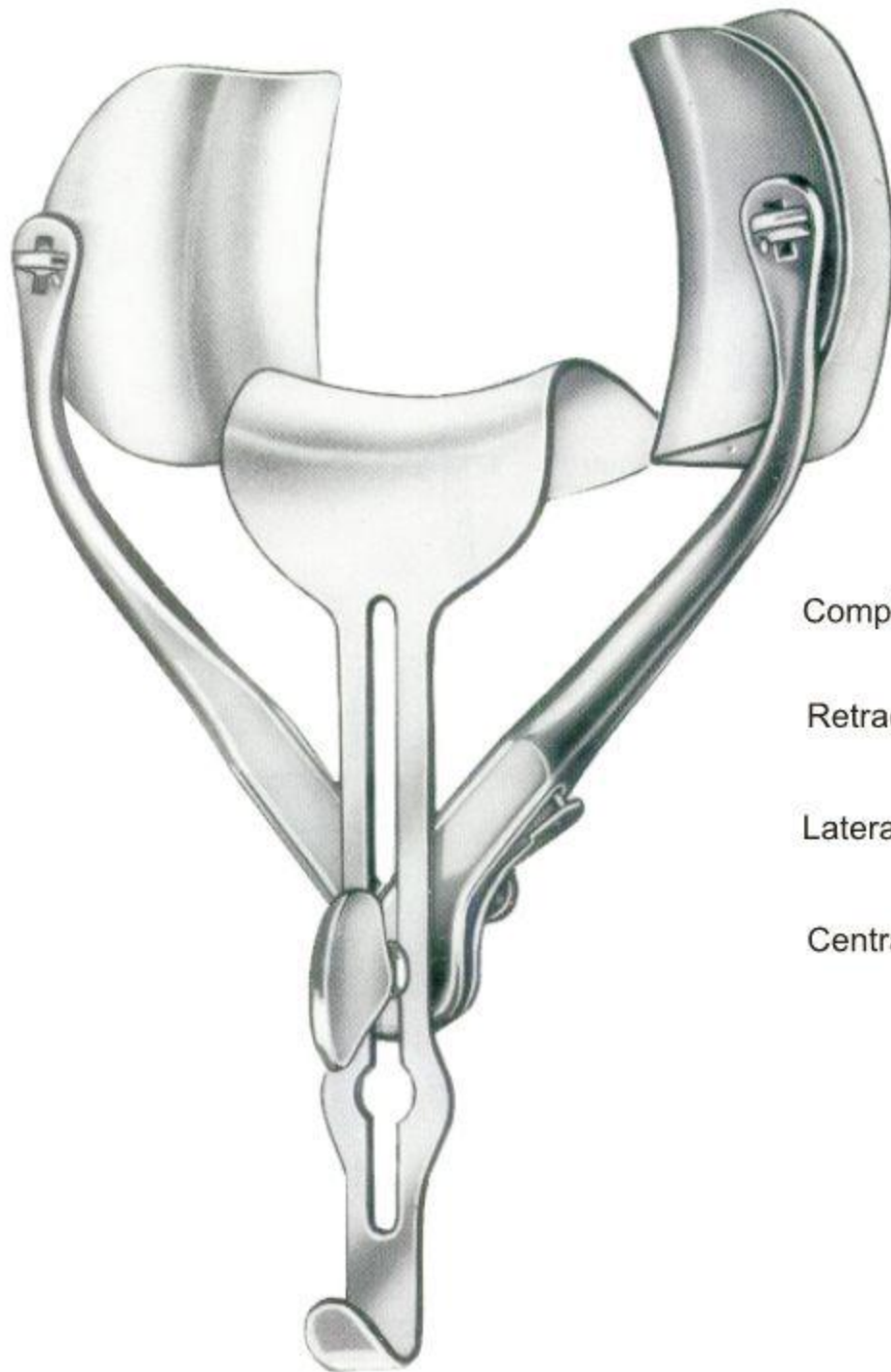

Ricard
11-3308-00 28cm/11"
11-3308-00 30cm/12"

	Fig. 1 11-3309-00	Fig. 2 11-3310-00
Complete		
Retractors Only	11-3309-01	11-3310-01
Lateral Blades	11-3309-02 60x80 mm	11-3310-02 75x85 mm
Central Only	11-3309-03 53x70 mm	11-3310-03 80x90 mm

Vulval Retractor



Richter
11-3310-16
16.5 cm/6½"



Gelpi
11-3311-09 9 cm/3½"
11-3311-11 11 cm/4½"
11-3311-13 13 cm/5"
11-3311-19 19 cm/7½"



Gelpi
11-3312-19
19 cm/7½"



Meyerding
Fig. 1 11-3313-01
Fig. 2 11-3313-02
Fig. 3 11-3313-03
Fig. 4 11-3313-04
18 cm/7"

Blades

- Fig. 1 1¾"x1"
- Fig. 2 2⅛"x1"
- Fig. 3 2⅜"x1¾"
- Fig. 4 2⅜"x1"



Markham-Meyerding
 11-3314-18 18cm/7" 11-3315-18

Rigby
 11-3316-19 19cm/7½"

De Bakey
 11-3317-12 12cm/4 ¾"
 11-3317-17 17cm/6 ¾"

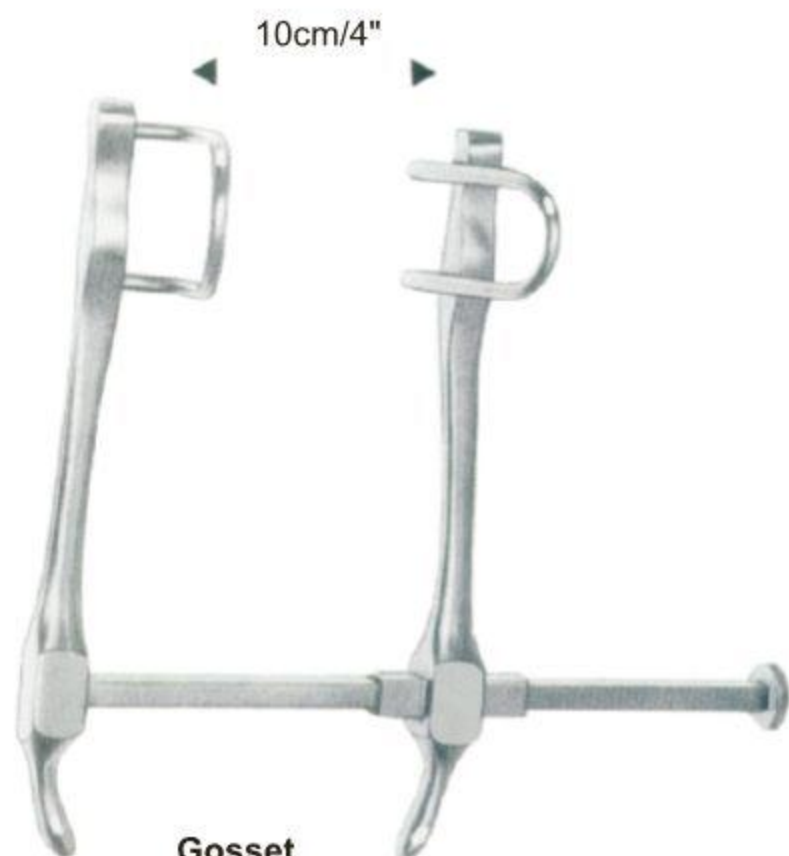

Gosset
 11-3318-00

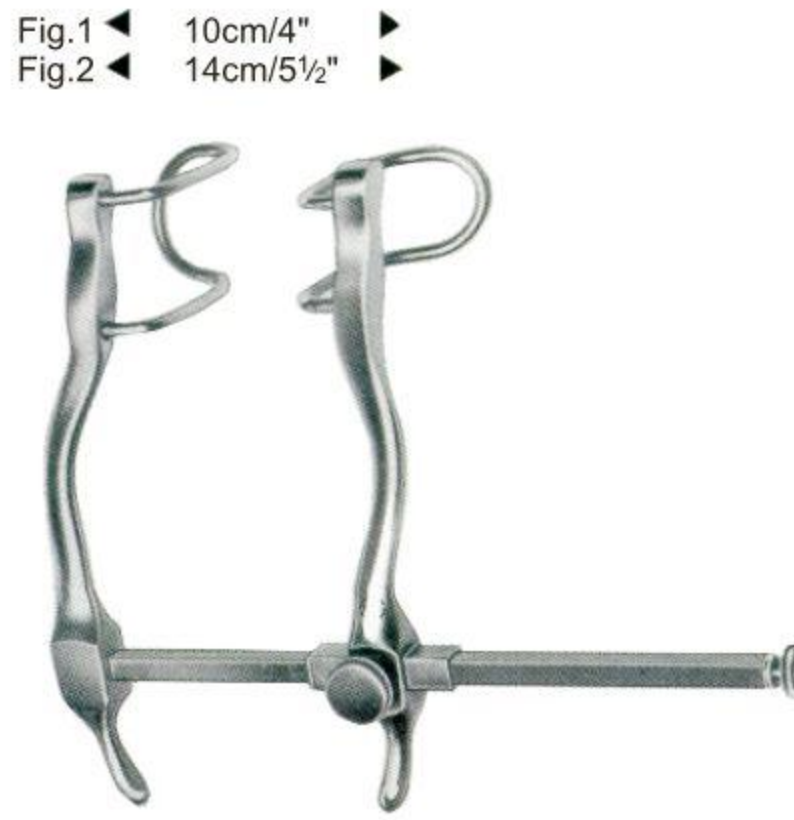

Fig.1 ◀ 10cm/4" ▶
 Fig.2 ◀ 14cm/5½" ▶

Gosset
 Fig.1 11-3319-01
 Fig.2 11-3319-02



Gosset
11-3320-00

Retractors Only
11-3320-01

Central Blade
11-3320-02
56X60mm



Hertzler
11-3321-00

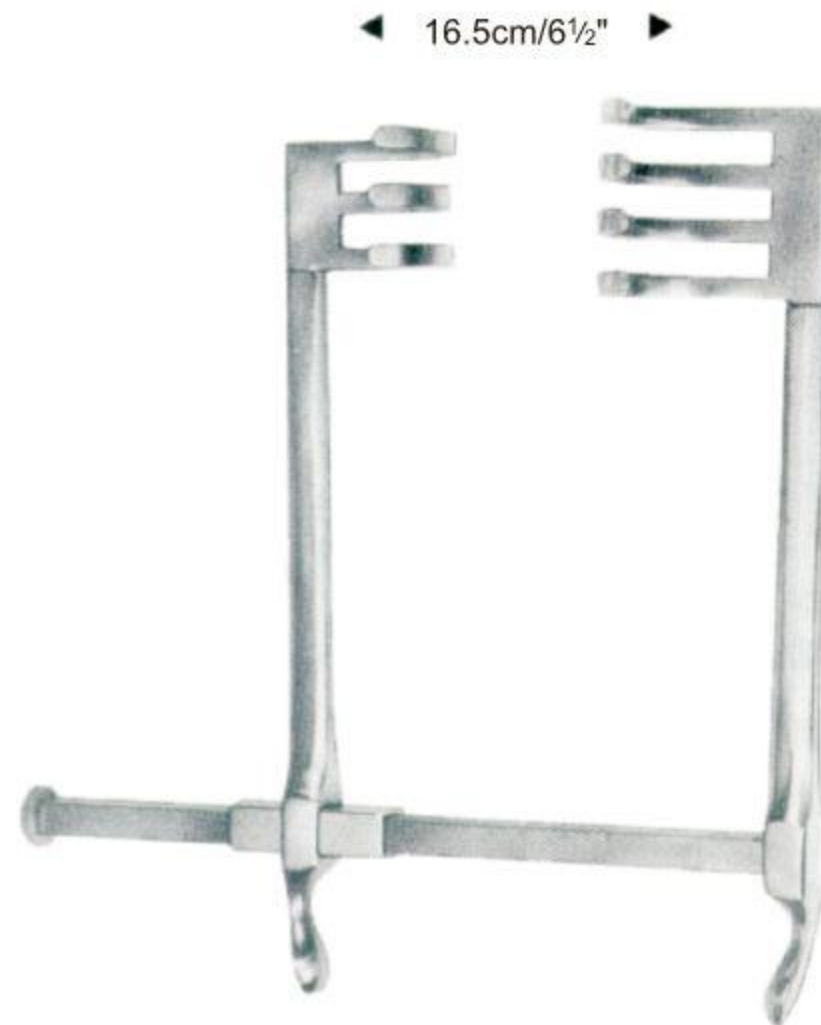

Frazier
11-3322-00

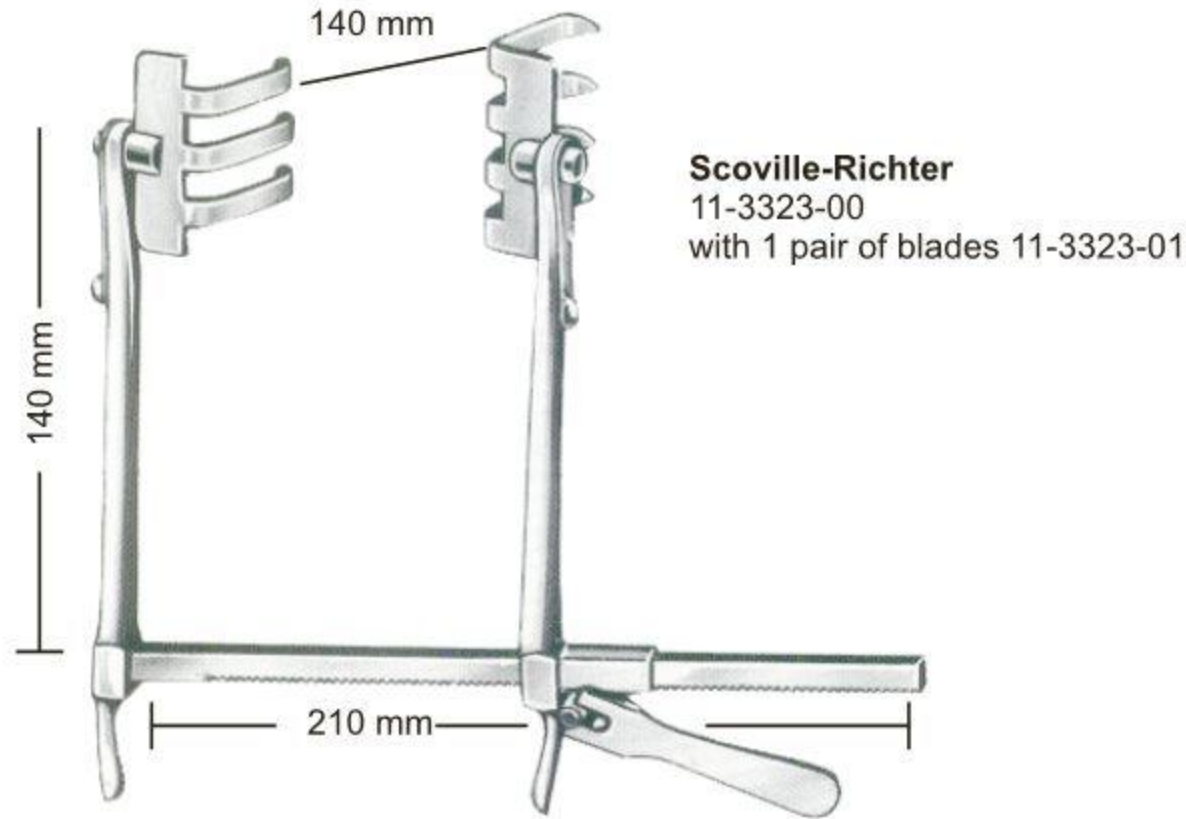

the blades are available by pairs

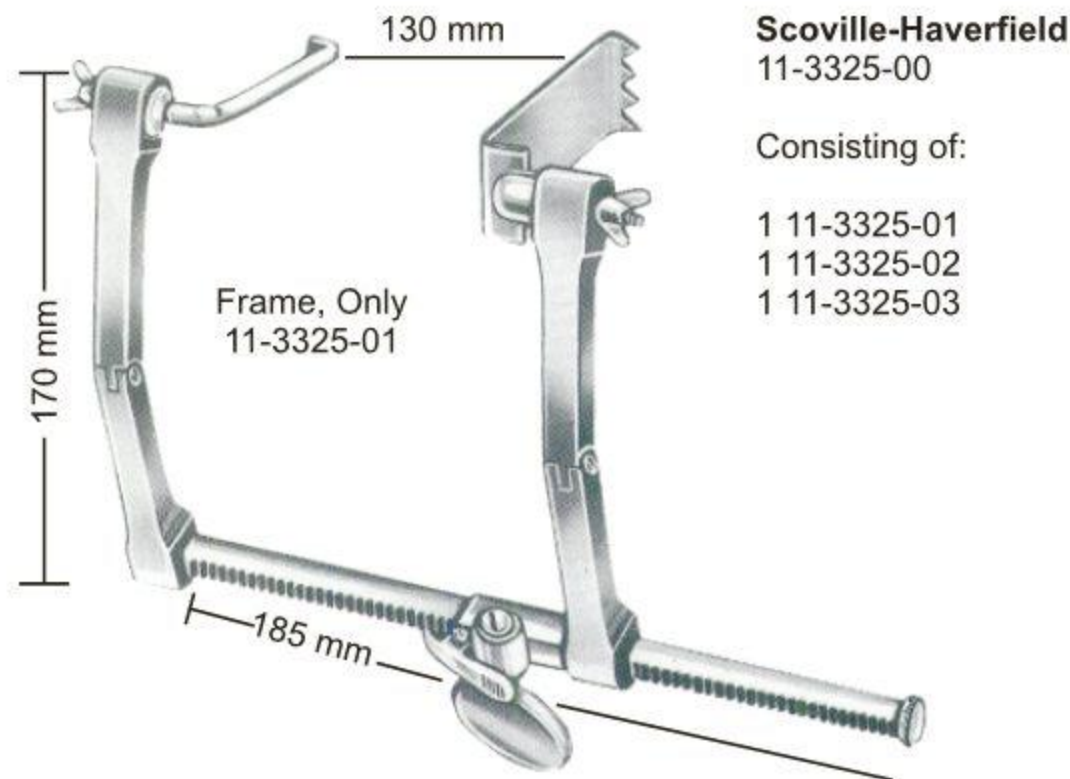
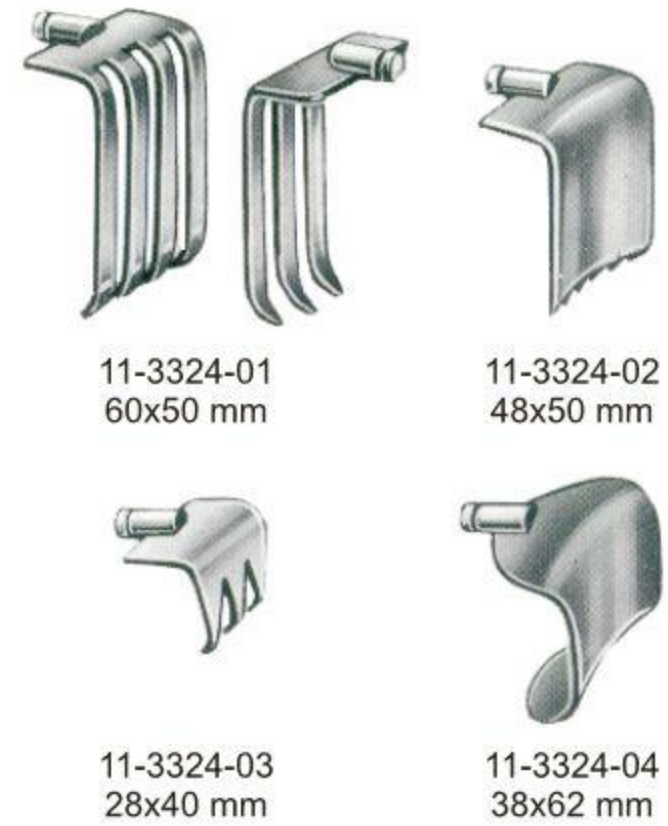

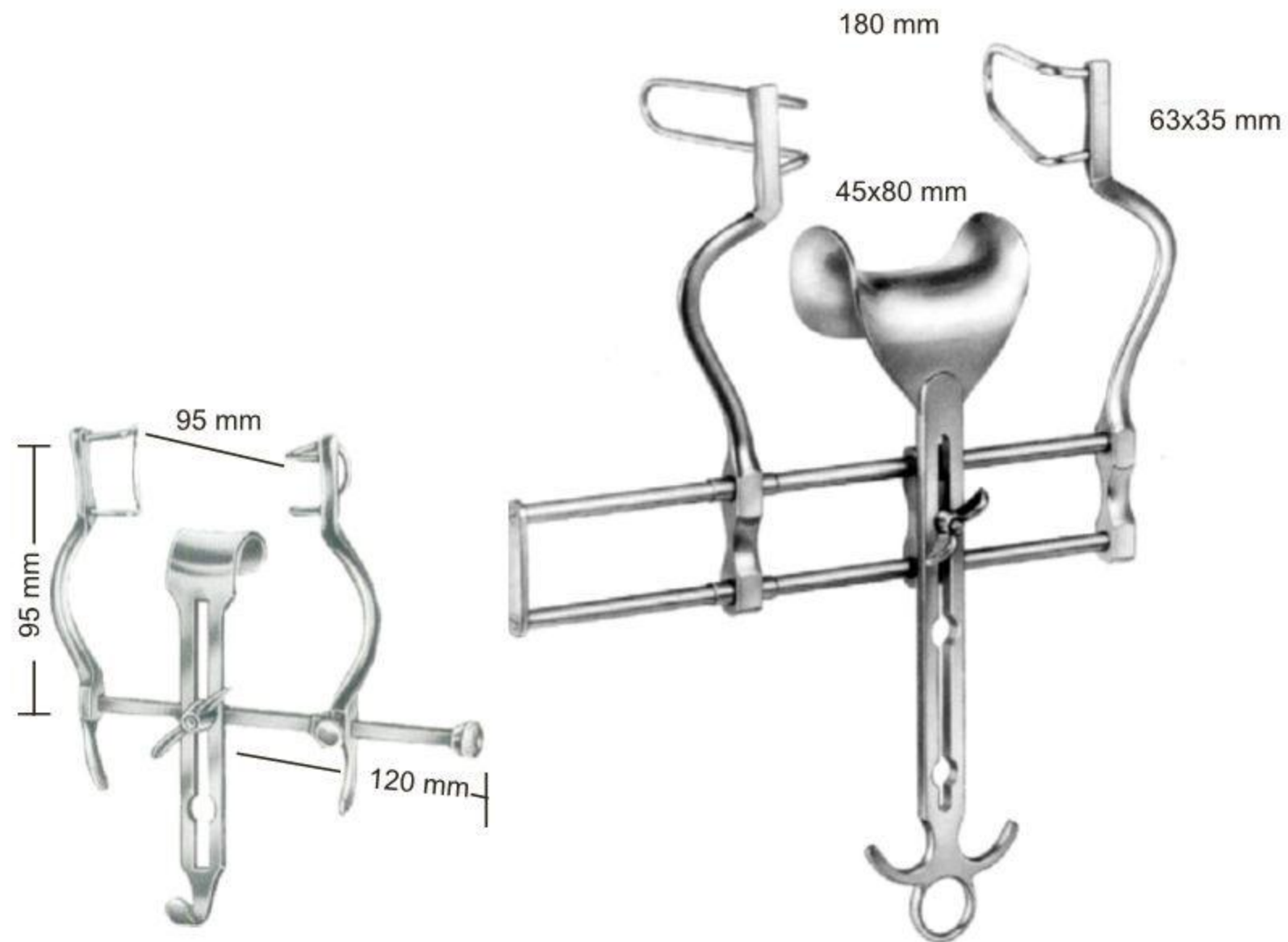

	Baby-Balfour 11-3327-00	Balfour 11-3328-00
Retractor Complete		
Retractor Only	11-3327-01	11-3328-01
Central Blade Only	11-3327-02	11-3328-02

Abdominal Retractors ● EN
 Bauchdeckenhalter ● DE
 Separadores abdominales ● ES



Retractor Complete
11-3329-00

Retractor Only
11-3329-01

Central Blade Only
11-3329-02

Balfour

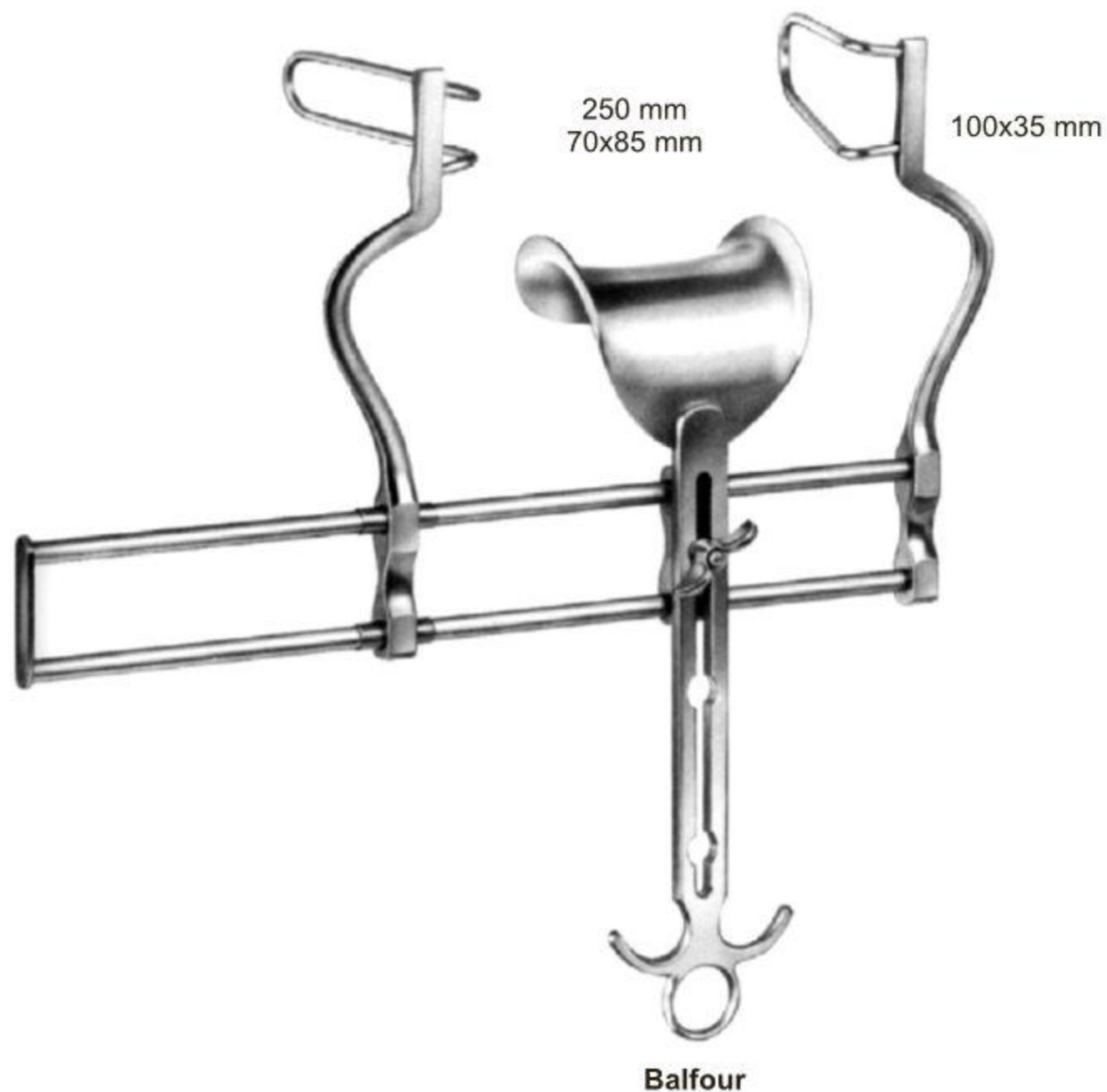

Retractor, Complete
11-3330-00

Retractor Only
11-3330-01

Central Blade Only
11-3330-02

Balfour

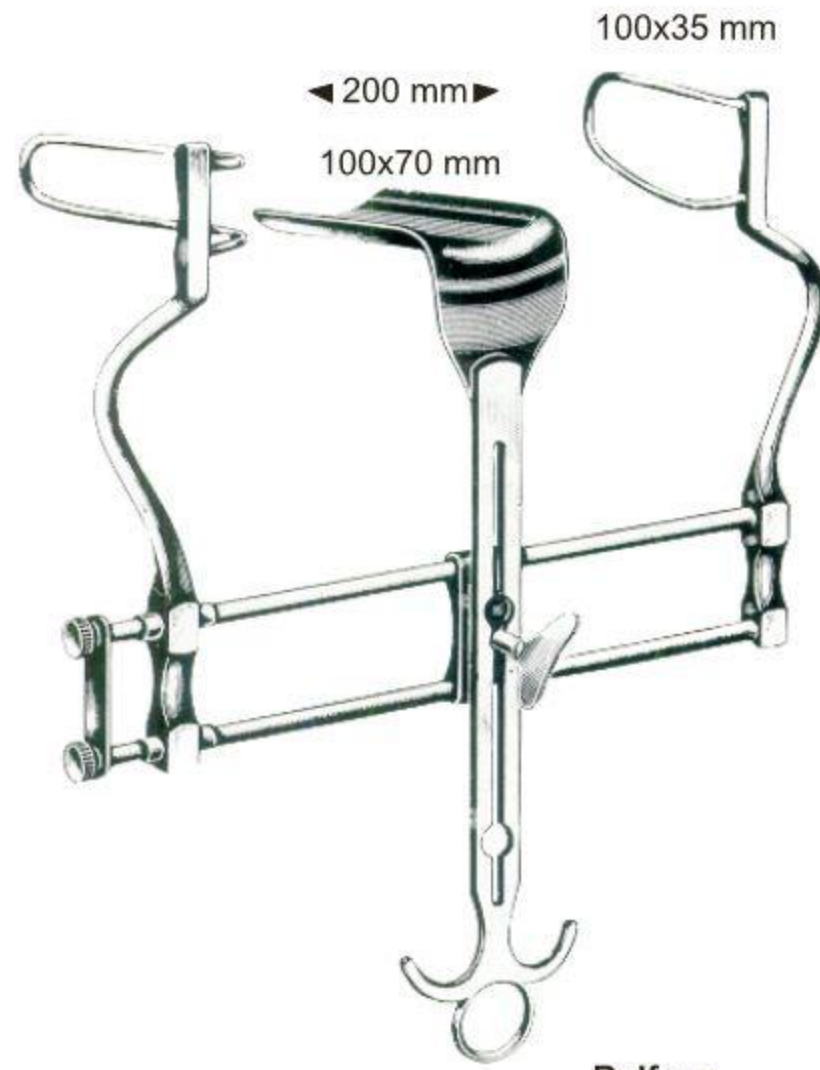

Balfour

Retractor, complete
11-3331-00
Retractor, only
11-3331-01
Central blade, only
11-3331-02

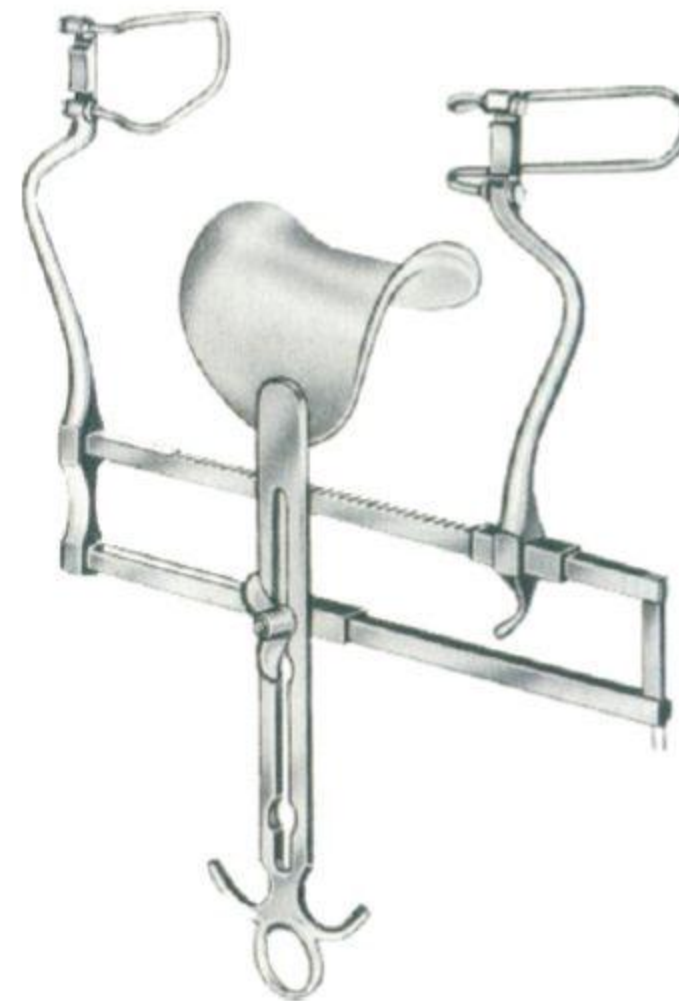

Balfour USA-Modell

Retractor, complete	11-3332-00
Retractor, only	11-3332-01
Central blade, only	11-3332-02
45x68 mm	11-3332-03
Lateral blades, only	11-3332-04
60 mm	11-3332-05
	80 mm

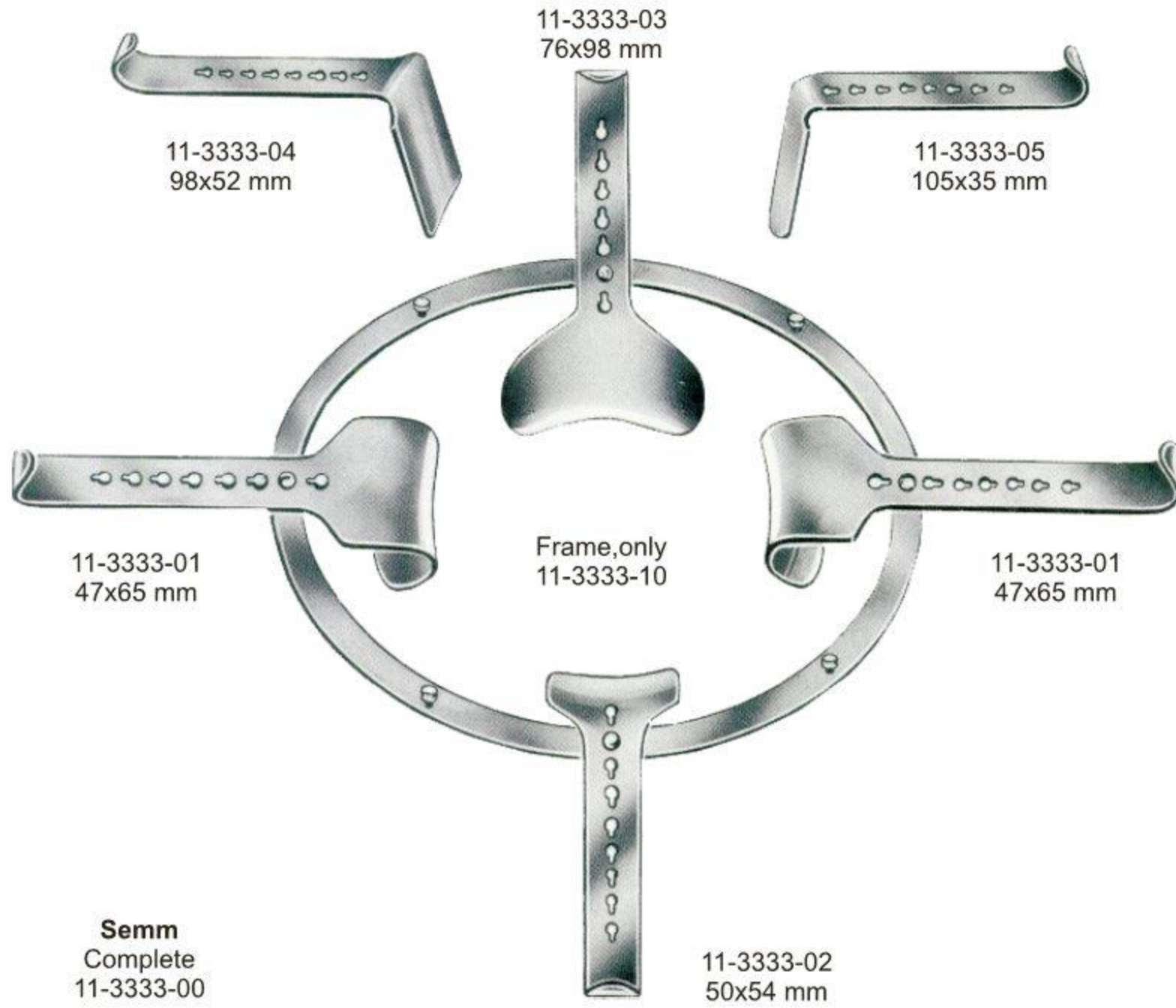

Kirschner
 Complete
 11-3334-00
 1x 11-3334-10
 2x 11-3334-01
 2x 11-3334-02



Kirschner
 Complete
 11-3336-00
 1x 11-3336-10
 2x 11-3336-01
 2x 11-3336-02

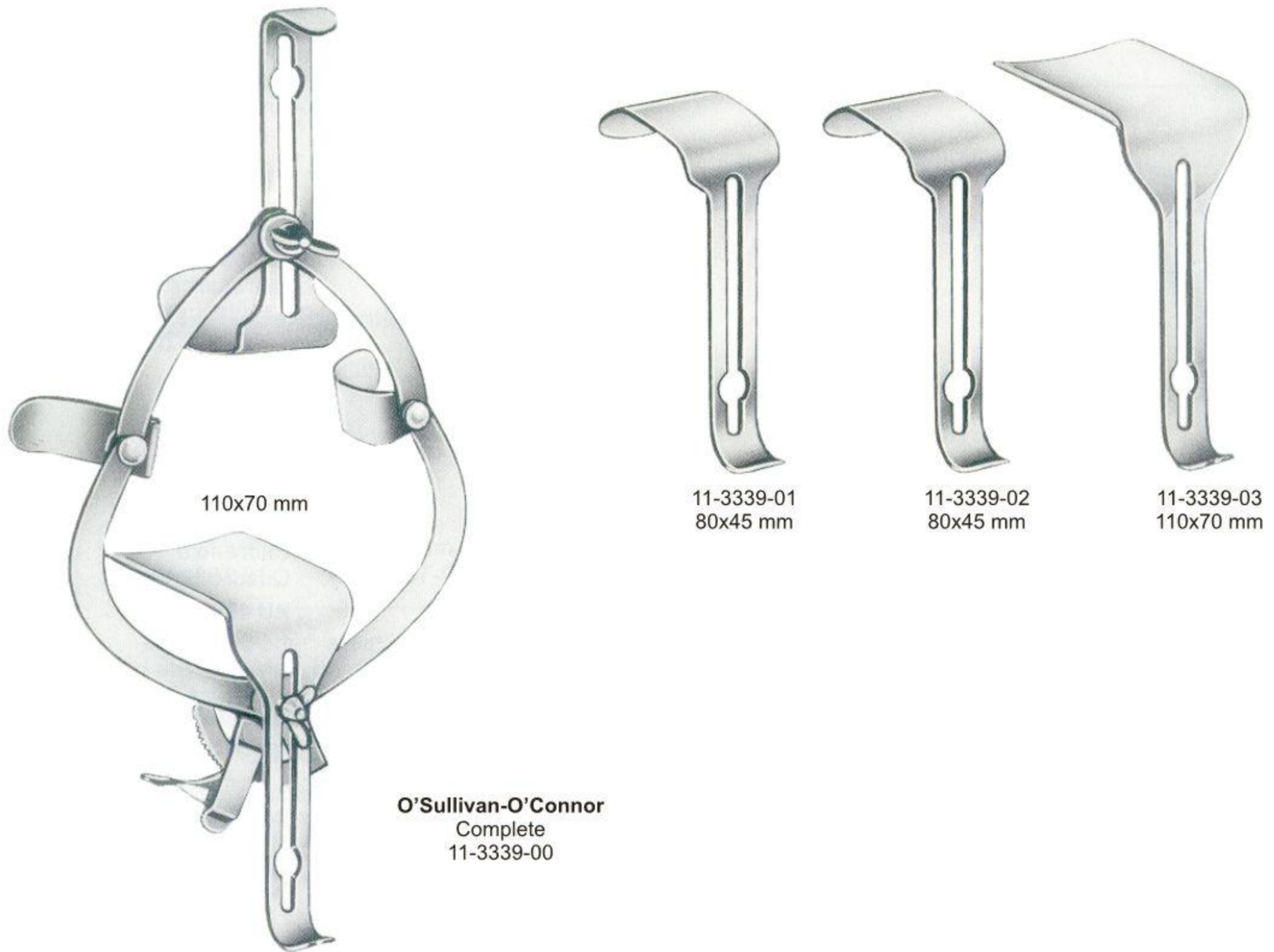
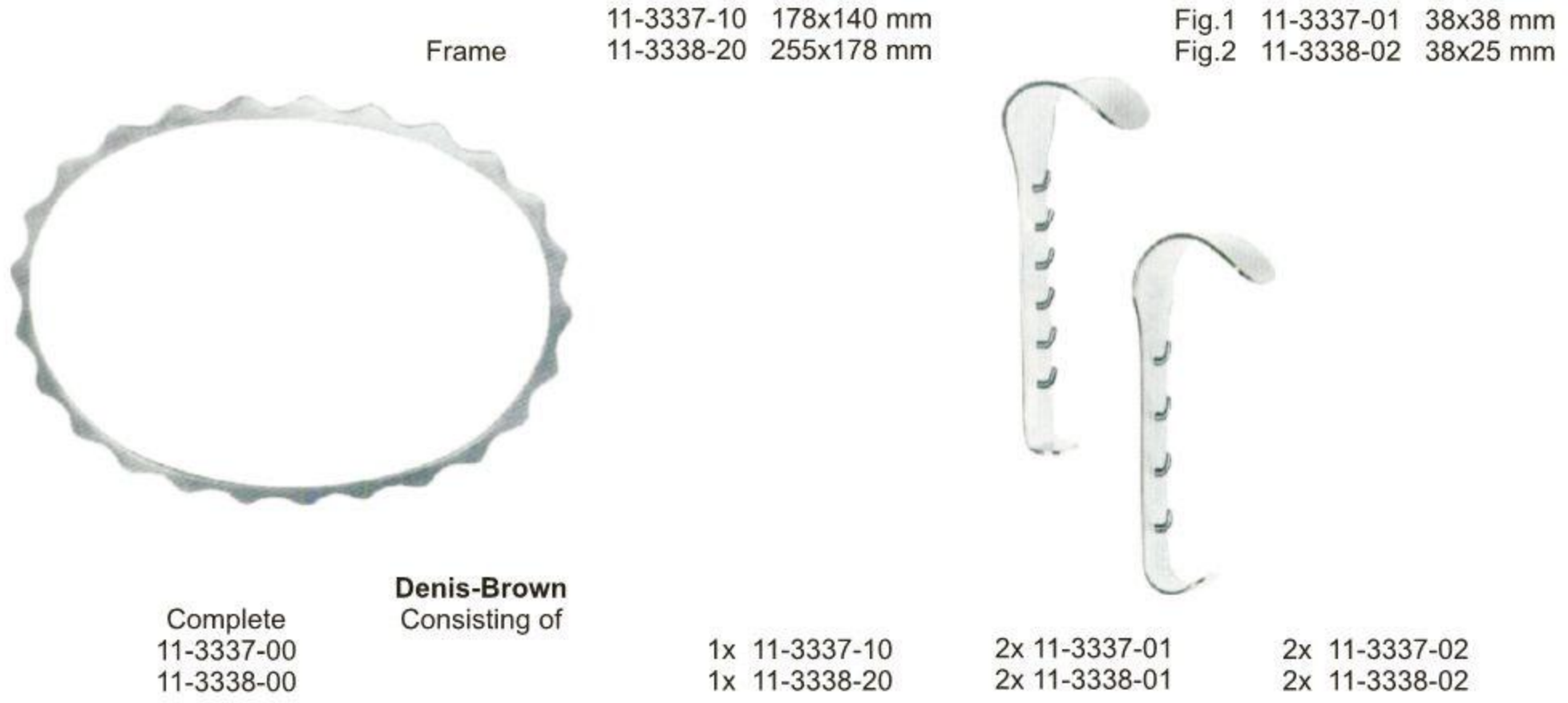

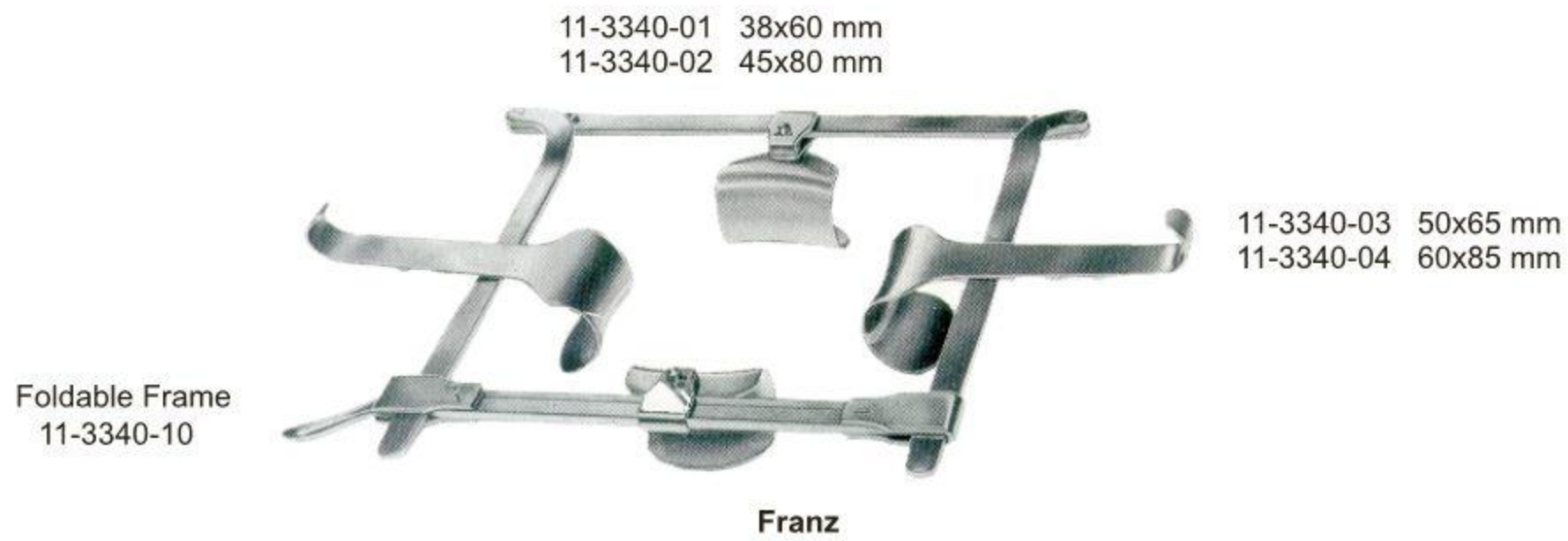

Complete with 4 valves 11-3340-00	With con	11-3340-10 1x 11-3340-01 2x 11-3340-03 2x
Complete with 8 valves 11-3341-00	With con	11-3340-10 1x 11-3340-01 2x 11-3340-02 2x 11-3340-03 2x 11-3340-04 2x



- EN** Bone Surgery
- DE** Knochenchirurgie
- ES** Cirugía ósea

Page 243 to 314





Mead
12-3501-17 17.0cm
26mm Ø, 320 g (11¼ oz)



Partsch
12-3502-18 18.0cm
22mm Ø, 200 g (7 oz)



12-3503-30
30mm Ø, 510 g

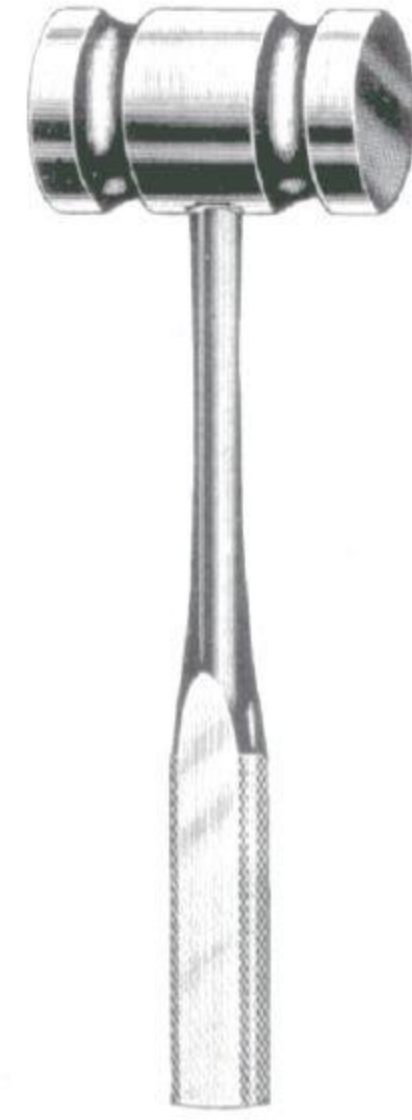

12-3504-25 250 g
12-3505-45 450 g
12-3506-90 900 g
26.5cm



12-3507-18 18.5cm
25mm Ø 135 g



lead filled

12-3508-19 19.0cm
22mm Ø 155 g



Hajek
12-3509-22 22.0cm
27mm Ø 130 g

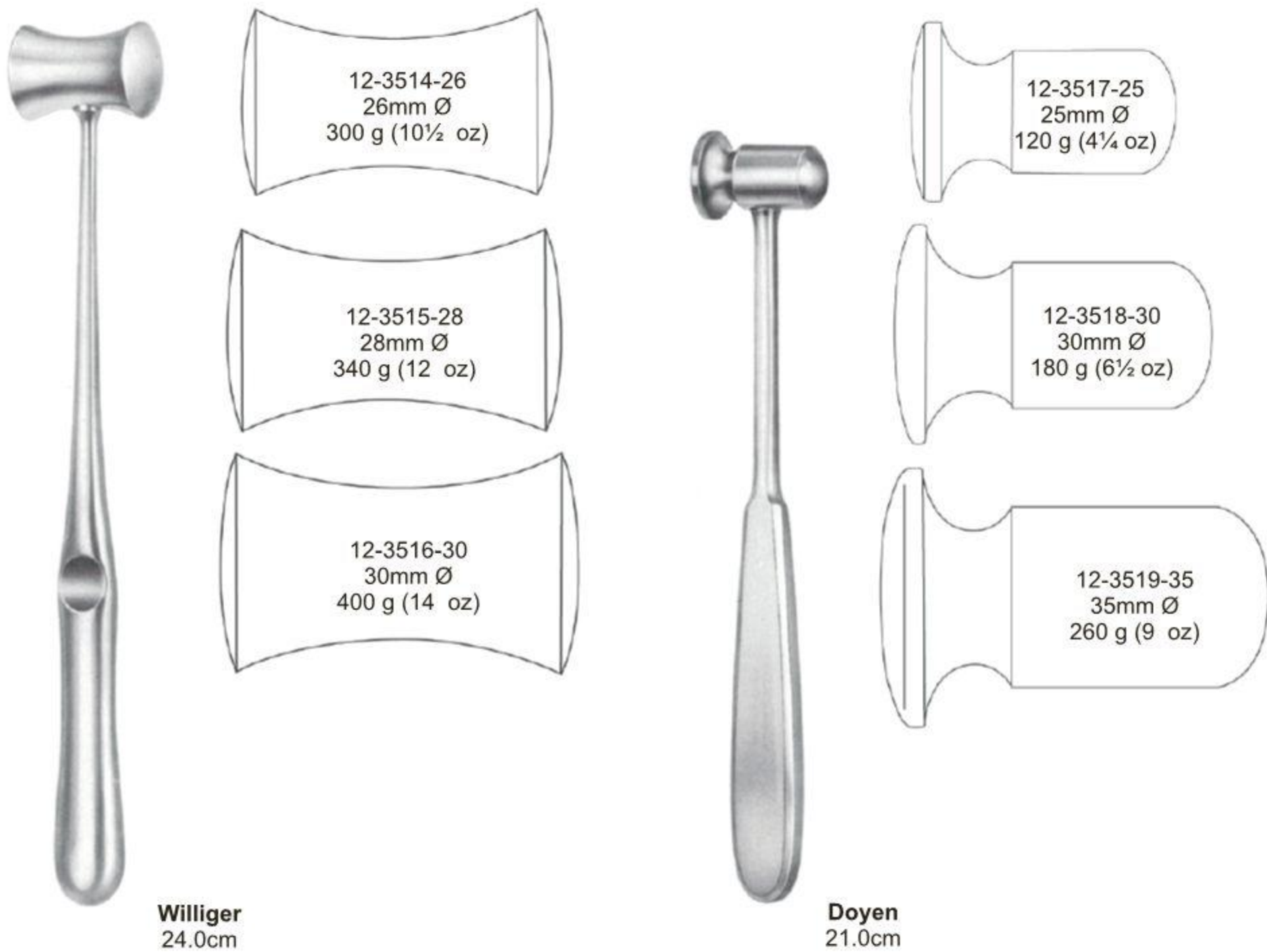



Gerzog
12-3520-18 18.0cm
250 g

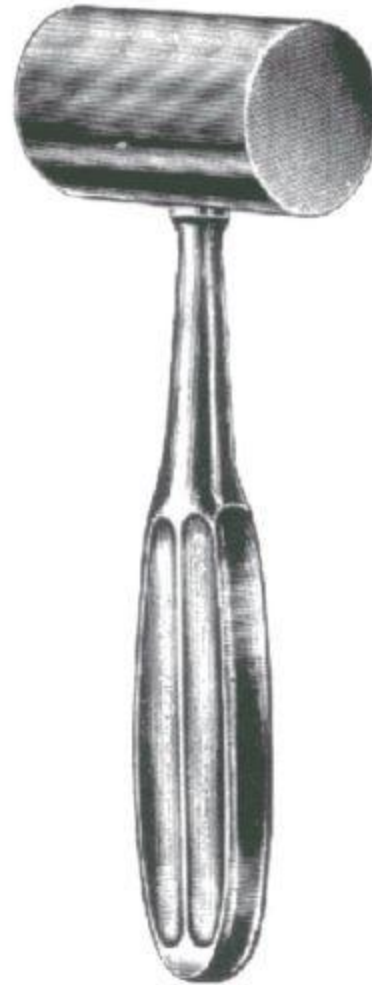

Kirk
12-3521-19 19.0cm
750 g

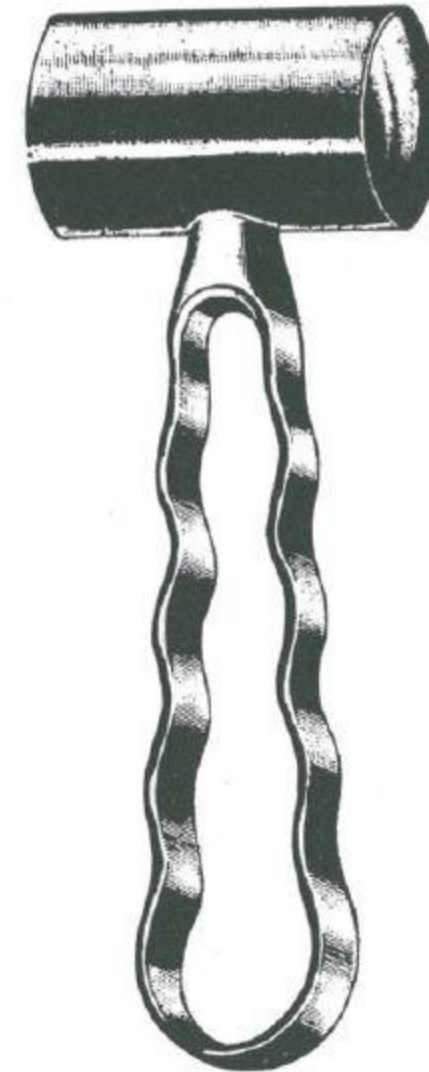

Heath
18.0cm
12-3522-35 35mm Ø (28 oz)
12-3522-40 40mm Ø (36 oz)



12-3523-26
26.5cm 530 g (19 oz)



12-3524-24
24.0cm (30mm Ø 480 g)



12-3525-22
22.5cm (37mm Ø 370 g)



12-3526-24 24.0cm

Mallets ● EN
 Hämmer ● DE
 Martillos y Mazos ● ES



12-3527-26 26.5cm
 30mm Ø, 510 g (18 oz)



12-3528-26 26.5cm



12-3529-25 26.5cm 250 g (0.55 lbs)
 12-3529-45 26.5cm 450 g (1 lbs)
 12-3529-90 26.5cm 900 g (2 lbs)



mm
02 12-3530-02
03 12-3530-03
04 12-3530-04
05 12-3530-05
06 12-3530-06
07 12-3530-07
08 12-3530-08
13.5 cm/5¼"



mm
02 12-3531-02
03 12-3531-03
04 12-3531-04
05 12-3531-05
06 12-3531-06
07 12-3531-07
08 12-3531-08
17 cm/6¾"

mm
04 12-3533-04
06 12-3533-06
08 12-3533-08
10 12-3533-10
12 12-3533-12
14 12-3533-14
16 12-3533-16
13.5 cm/5¼"



Width

mm
04 12-3534-04
06 12-3534-06
08 12-3534-08
10 12-3534-10
12 12-3534-12
14 12-3534-14
16 12-3534-16
13.5 cm/5¼"



mm
06 12-3537-06
12 12-3537-12
18 12-3537-18



mm
06 12-3538-06
12 12-3538-12
18 12-3538-18
16 cm/6¼"



mm
06 12-3539-06
12 12-3539-12
18 12-3539-18



16 cm/6¼"



12-3540-03 3mm
12-3540-05 5mm
12-3540-07 7mm
212-3540-09 9mm



mm
02 12-3541-02
03 12-3541-03
12 cm/4¾"

12-3541-02 2.5mm
12-3541-03 3.5mm



Lexer
 27.5 cm/10¾"

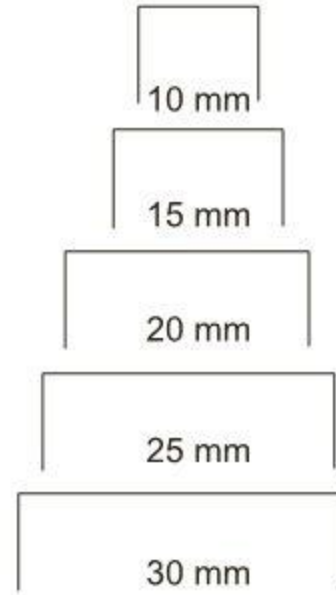

- 12-3542-10
- 12-3542-15
- 12-3542-20
- 12-3542-25
- 12-3542-30

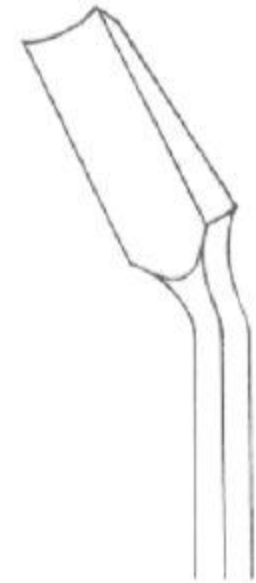

- 12-3543-10
- 12-3543-15
- 12-3543-20
- 12-3543-25
- 12-3543-30



Cloward
 24 cm/9½"

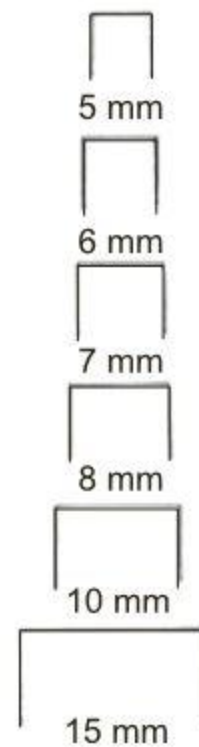

- 12-3544-05
- 12-3544-06
- 12-3544-07
- 12-3544-08
- 12-3544-10
- 12-3544-15



- 12-3545-05
- 12-3545-06
- 12-3545-07
- 12-3545-08
- 12-3545-10
- 12-3545-15



Alexander
18 cm/7"

	mm
12-3546-04	04
12-3546-06	06
12-3546-08	08
12-3546-10	10
12-3546-12	12
12-3546-14	14



12-3547-04
12-3547-06
12-3547-08
12-3547-10
12-3547-12
12-3547-14



Hoke

14 cm/5½"

	mm	
12-3548-02	2	12-3549-02
12-3548-03	3	12-3549-03
12-3548-04	4	12-3549-04
12-3548-05	5	12-3549-05
12-3548-06	6	12-3549-06
12-3548-07	7	12-3549-07
12-3548-08	8	12-3549-08



Smith-Petersen
20 cm/8"

mm				
06	12-3550-06	12-3551-06	12-3552-06	12-3553-06
09	12-3550-09	12-3551-09	12-3552-09	12-3553-09
13	12-3550-13	12-3551-13		
14			12-3552-14	12-3553-14
16	12-3550-16	12-3551-16	12-3552-16	12-3553-16
19	12-3550-19	12-3551-19	12-3552-19	12-3553-19
25	12-3550-25	12-3551-25	12-3552-25	12-3553-25
32	12-3550-32	12-3551-32	12-3552-32	12-3553-32



Lambotte

	mm	
12-3554-04	04	12-3555-04
12-3554-06	06	12-3555-06
12-3554-08	08	12-3555-08
12-3554-10	10	12-3555-10
12-3554-13	13	12-3555-13
12-3554-16	16	12-3555-16
12-3554-18	18	12-3555-18
12-3554-20	20	12-3555-20
12-3554-25	25	12-3555-25
12-3554-30	30	12-3555-30
12-3554-38	38	12-3555-38
12-3554-44	44	12-3555-44
12-3554-50	50	12-3555-50

24 cm/9½"

Curved

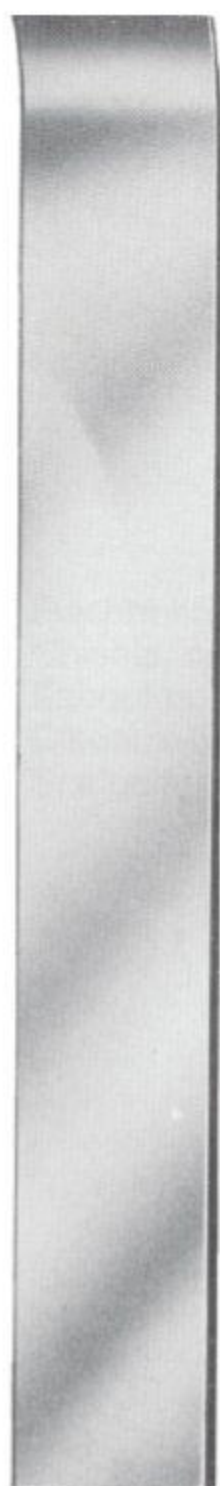

23 cm/9"



Mini-Lambotte

	mm	
12-3556-02	02	12-3557-02
12-3556-03	03	12-3557-03
12-3556-04	04	12-3557-04
12-3556-06	06	12-3557-06
12-3556-08	08	12-3557-08
12-3556-10	10	12-3557-10
12-3556-12	12	12-3557-12
12-3556-15	15	12-3557-15
12.5 cm/5"		17 cm/6¾"



Mini-Lexer

	mm	
12-3558-04	04	12-3559-04
12-3558-06	06	12-3559-06
12-3558-08	08	12-3559-08
12-3558-10	10	12-3559-10
12-3558-12	12	12-3559-12

18 cm/7"



Lexer

	mm	
12-3560-05	05	12-3561-05
12-3560-07	07	12-3561-07
12-3560-10	10	12-3561-10
12-3560-15	15	12-3561-15
12-3560-20	20	12-3561-20
12-3560-25	25	12-3561-25
12-3560-30	30	12-3561-30

22 cm/8¾"





Chisel
12-3562-20
24.5 cm/9 3/4"
20 mm



Chisel-Curved
12-3563-20
26.5 cm/10 1/2"
20 mm

Gouge for the
removing of
broken screws



12-3564-22
22 cm/8 3/4"



Zielke
 23 cm/9"
 5.5 mm
 9.0 mm

12-3565-05
 12-3565-09

Stille
 20 cm/8"

mm
 06
 08
 10
 12
 15
 20
 25
 30

Width



12-3566-06	12-3567-06	12-3568-06	12-3569-06	12-3570-06
12-3566-08	12-3567-08	12-3568-08	12-3569-08	12-3570-08
12-3566-10	12-3567-10	12-3568-10	12-3569-10	12-3570-10
12-3566-12	12-3567-12	12-3568-12	12-3569-12	12-3570-12
12-3566-15	12-3567-15	12-3568-15	12-3569-15	12-3570-15
12-3566-20	12-3567-20	12-3568-20	12-3569-20	12-3570-20
12-3566-25	12-3567-25	12-3568-25	12-3569-25	12-3570-25
12-3566-30	12-3567-30	12-3568-30	12-3569-30	12-3570-30



Hibbs
 24 cm/9½"

mm
 06
 09
 13
 16
 19
 25
 32

12-3571-06	12-3572-06	12-3573-06	12-3574-06	12-3575-06
12-3571-09	12-3572-09	12-3573-09	12-3574-09	12-3575-09
12-3571-13	12-3572-13	12-3573-13	12-3574-13	12-3575-13
12-3571-16	12-3572-16	12-3573-16	12-3574-16	12-3575-16
12-3571-19	12-3572-19	12-3573-19	12-3574-19	12-3575-19
12-3571-25	12-3572-25	12-3573-25	12-3574-25	12-3575-25
12-3571-32	12-3572-32	12-3573-32	12-3574-32	12-3575-32



12-3579-01

12-3579-02



12-3579-03

Cobb
28 cm/11"

12-3579-04

mm **Lexer**
05 12-3576-05
10 12-3576-10
15 12-3576-15
28 cm/11"

Lexer
12-3577-05
12-3577-10
12-3577-15
25 cm/10"

Lexer
12-3578-05
12-3578-10
12-3578-15
25 cm/10"

Bone Files ●— EN
 Knochenfeile ●— DE
 Lima para huesos ●— ES



Putti
 12-3580-30
 30 cm/12"



Putti
 12-3581-27
 27 cm/10½"



12-3582-25
 25 cm/10"



12-3583-24
 24 cm/9½"



12-3584-22
 22 cm/8¾"





Width

Lambotte
21 cm/8¼"

	mm
12-3585-05	05
12-3585-10	10
12-3585-15	15
12-3585-20	20
12-3585-25	25



Schneider
12-3586-17
13 mm
17.5 cm/7"



Schneider-Sauerbruch
12-3587-19
13 mm
19 cm/7½"



Alexander
12-3588-20
20 cm/8"



Jansen
12-3589-16
15 mm
16.5 cm/6½"



Seldin
12-3590-19
19 cm/7½"



Davidson-Alexander
12-3591-29
29 cm/11½"



Williger
12-3592-29
13 cm/5"

Periosteal Raspatories ●— EN
 Raspatorien ●— DE
 Legras-Periostótomos ●— ES

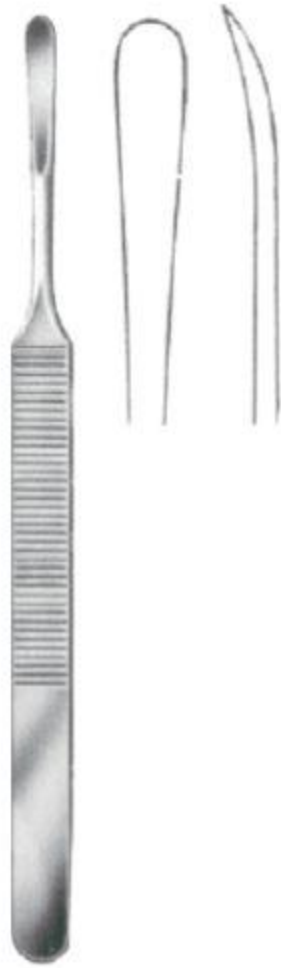

König
 12-3593-15
 15.5 cm/6"
 5 mm

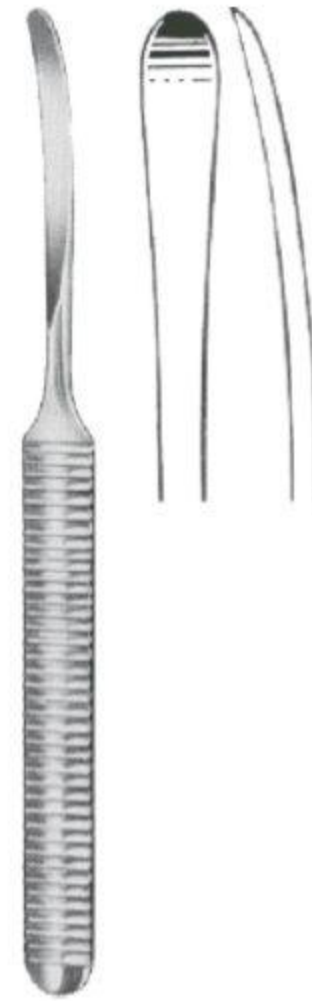

Williger
 12-3594-16
 16 cm/6¼"



Adson
 17 cm/6¾"



12-3595-01



12-3595-02



12-3595-03



12-3595-04



12-3596-06
 6 mm

17 cm/6¾"

12-3597-08
 8 mm

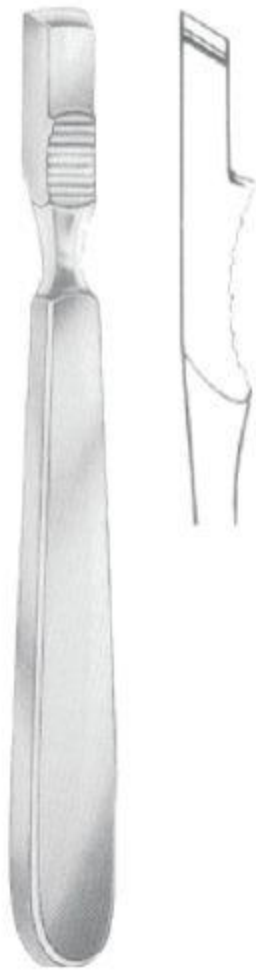

Farabeuf
12-3598-15
15 cm/6"



Farabeuf
12-3599-15
15 cm/6"



Farabeuf-Collin
12-3600-15
15.5 cm/6"
11 mm



Farabeuf-Collin
12-3601-15
15.5 cm/6"
11 mm



Farabeuf
12-3602-19
19 cm/7½"
13 mm

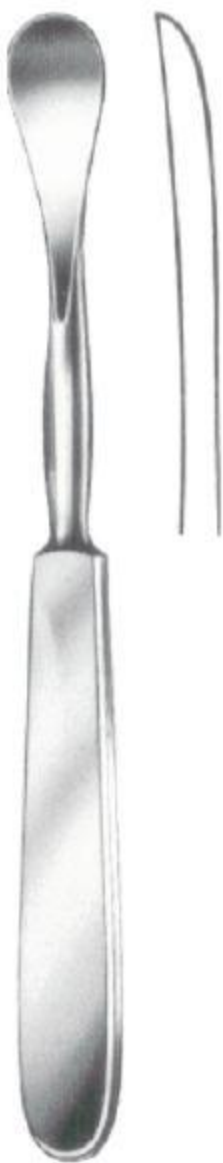

Sedillot
12-3603-18
18 cm/7"
18 mm



Sedillot
12-3604-21
21 cm/8¼"
15 mm



Langenbeck
12-3605-19
19 cm/7½"



Langenbeck
12-3606-18
18 cm/7"

Periosteal Raspatories ●— EN
 Raspatorien ●— DE
 Legras-Periostótomos ●— ES



Overholt
 12-3607-29
 29.5 cm/11½"



Overholt
 12-3608-29
 29.5 cm/11½"



Overholt
 12-3609-28
 28.5 cm/11¼"



Hylin
 12-3610-03
 14.5 cm/5¾"



12-3610-01



12-3610-02



12-3610-03



Matson
 12-3611-22
 22 cm/8¾"



Semb



12-3612-01
19.5 cm/7½"
12 mm



12-3613-02
19.5 cm/7½"
12 mm



12-3614-03
19.5 cm/7½"
12 mm



12-3615-04
22 cm/8¾"
13 mm



12-3616-05
21.5 cm/8½"
13 mm



12-3617-06
22 cm/8½"
15 mm



12-3618-07
22 cm/8½"
15 mm



Doyen
17 cm/6¾"

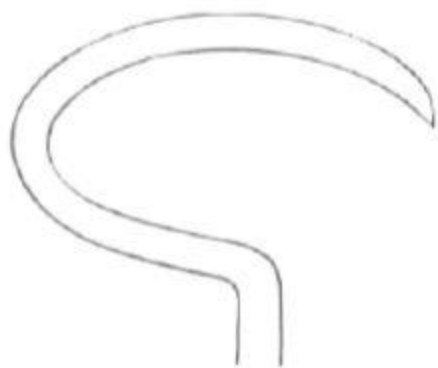

12-3619-01

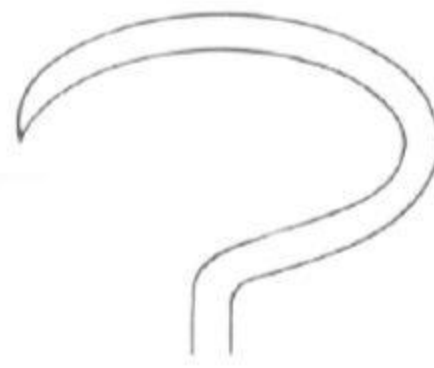

12-3619-02

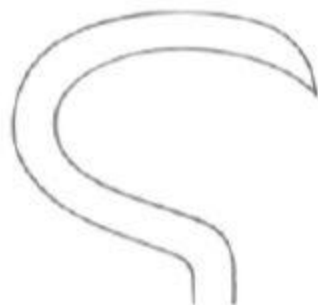

12-3620-01



12-3620-02



12-3621-01



Doyen
24 cm/9½" 12-3622-02

Periosteal Raspatories ●— EN
 Raspatorien ●— DE
 Legras-Periostótomos ●— ES



12-3623-04
4 mm



12-3623-06
6 mm



12-3623-08
8 mm



Cobb
24 cm/9½"



12-3623-10
10 mm



12-3623-13
13 mm



12-3623-19
19 mm



12-3623-25
25 mm



12-3624-01
19 cm/7½"
6 mm



12-3625-02
18.5 cm/7¼"
3 mm



12-3626-03
18.5 cm/7¼"
6 mm



12-3627-04
18.5 cm/7¼"
6 mm

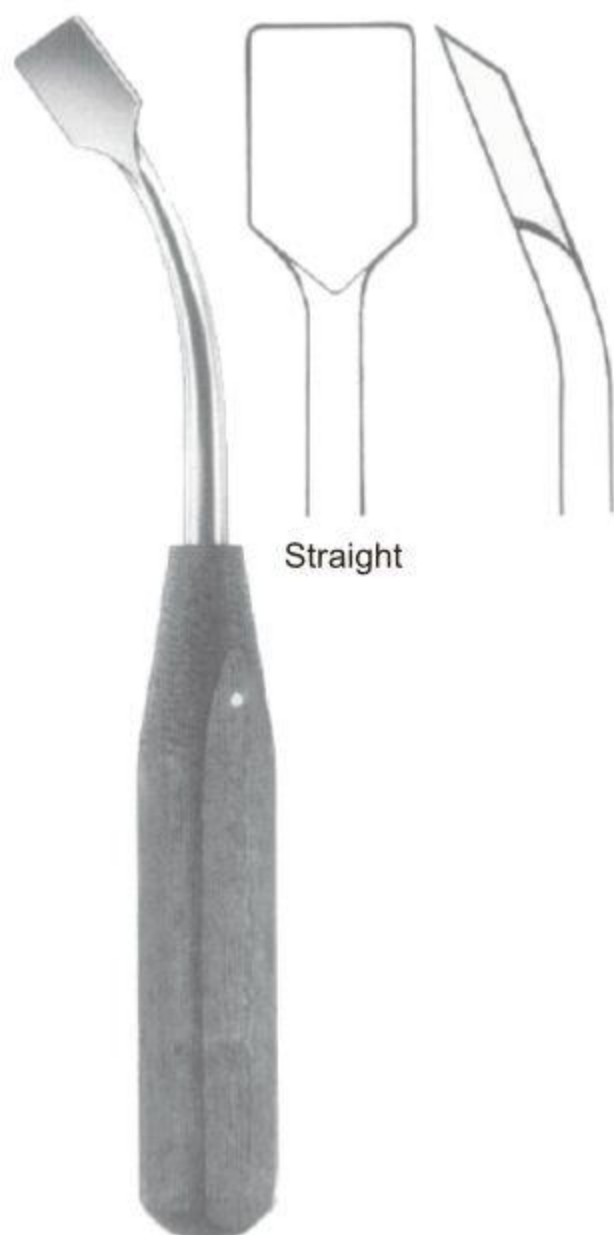

12-3628-05
18.5 cm/7¼"
13 mm



12-3629-06
19.5 cm/7¾"
14 mm



12-3630-07
18.5 cm/7¼"
14 mm



12-3631-08
20 cm/8"
20 mm

Periosteal Raspatories ●— EN
 Raspatorien ●— DE
 Legras-Periostótomos ●— ES



12-3632-20
 27.5 cm/10¾"
 20 mm



Wagner
 8 mm 12-3633-08 33 cm/13"
 17 mm 12-3633-17 33 cm/13"



Cobb
 10 mm 12-3634-10 25 cm/10"
 13 mm 12-3634-13 25 cm/10"
 19 mm 12-3634-19 25 cm/10"
 25 mm 12-3634-25 25 cm/10"



Cobb
 10 mm 12-3635-10 28 cm/11"
 13 mm 12-3635-13 28 cm/11"
 19 mm 12-3635-19 28 cm/11"



Hoehn

12-3636-07
16 cm/6¼"
7 mm

12-3636-15
18.5 cm/7¼"
15 mm

12-3636-20
19 cm/7½"
20 mm



Yankauer
12-3637-18
18 cm/7"



Langenbeck
12-3638-20
20 cm/8"
8 mm



Langenbeck
12-3639-20
20 cm/8"
10 mm



Langenbeck
12-3640-23
23 cm/9"
11 mm



Mass. Gen. Hosp.
12-3641-15
15 cm/6"



Williger
12-3642-17
17 cm/6¾"
5.5 mm



Williger
12-3643-16
16 cm/6¼"



Quervain
12-3644-20
20 cm/8"

Elevators ●— EN
 Elevatorien ●— DE
 Elevadores ●— ES



Alderdyce
 12-3645-16
 16 cm/6 1/4"

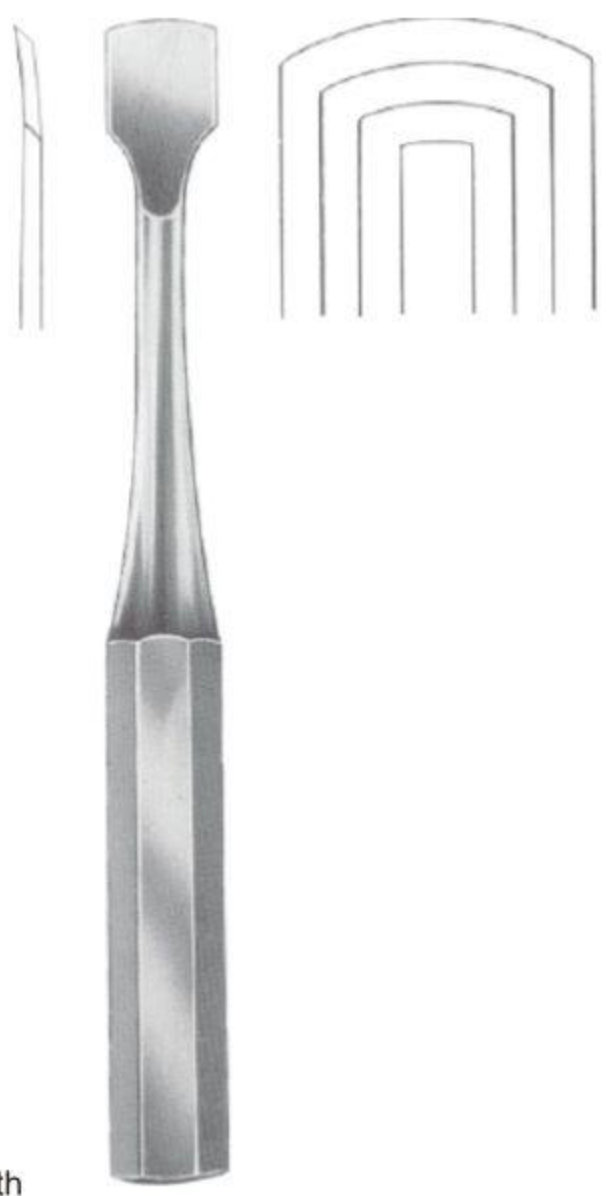

Key
 Width
 6 mm 12-3646-06 19 cm/7 1/2"
 12 mm 12-3646-12 19 cm/7 1/2"
 19 mm 12-3646-19 19 cm/7 1/2"
 25 mm 12-3646-25 19 cm/7 1/2"



Konig
 12-3647-15
 15 cm/6"
 4.5 mm



Konig
 12-3648-15
 15 cm/6"
 4.5 mm



Alderdyce
 12-3649-21
 21 cm/8 1/4"



McDonald
 12-3650-19
 19 cm/7 1/2"



Watson-Cheyne
 12-3651-19
 17.5 cm/7"



Sebileau
 12-3652-17
 17 cm/6 3/4"



12-3653-14
14 cm/5½"
2.8 mm

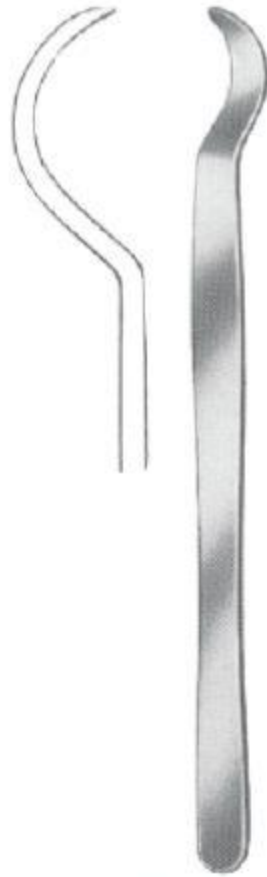

12-3654-15
15 cm/6"
5 mm



12-3655-15
15 cm/6"
7 mm

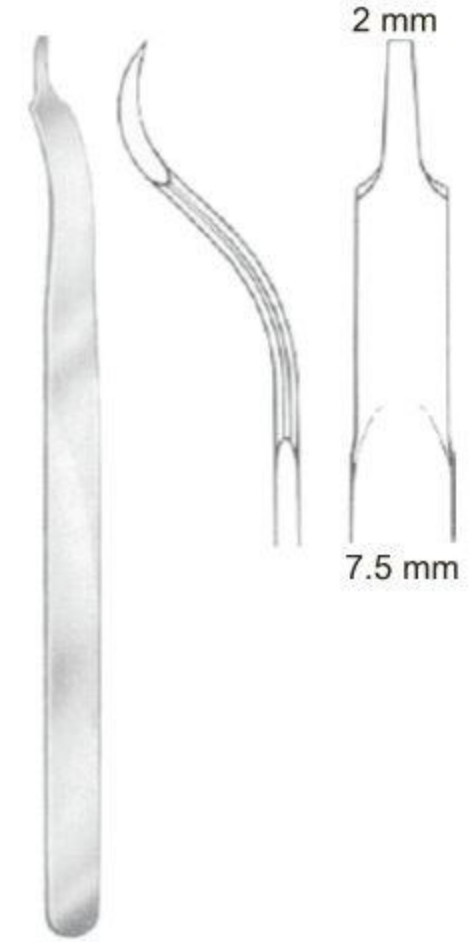

Buck-Gramcko
12-3656-15
15 cm/6"

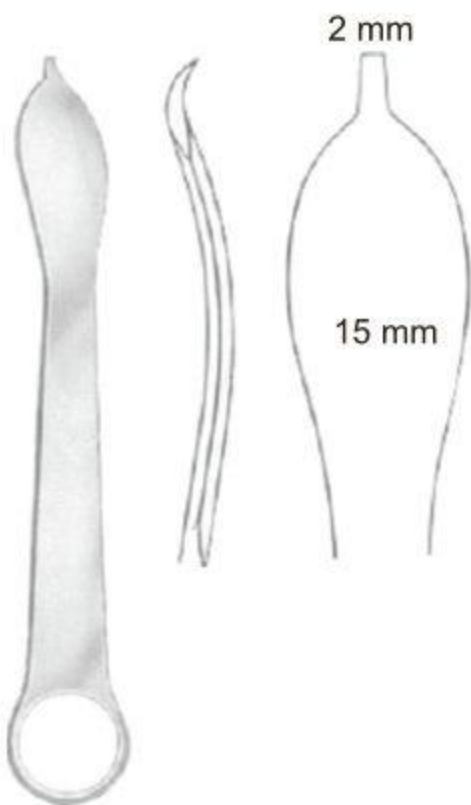

12-3657-12
12.5 cm/5"

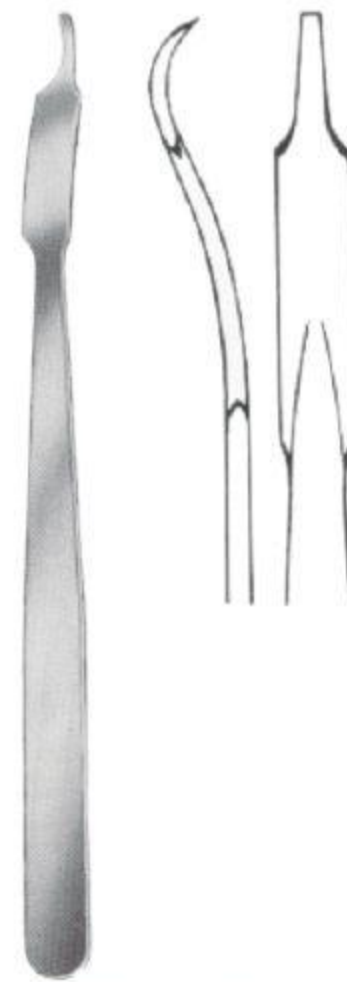

Mini-Hohmann
12-3658-06
16 cm/6¼"
6 mm



12-3658-08
8 mm



12-3659-17
 17 mm

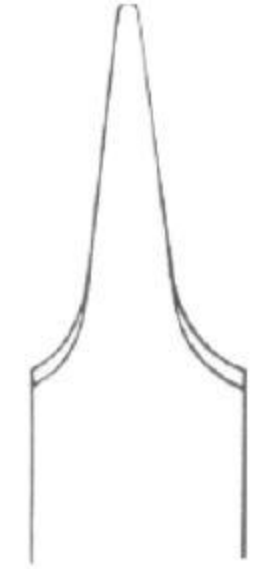

12-3660-17
 17 mm



12-3661-26
 26.5 cm/10½"
 24 mm



Lange-Hohmann
 12-3662-26
 26 cm/10¼"
 22 mm



Hohmann
 12-3663-22
 22 cm/8¾"
 8 mm

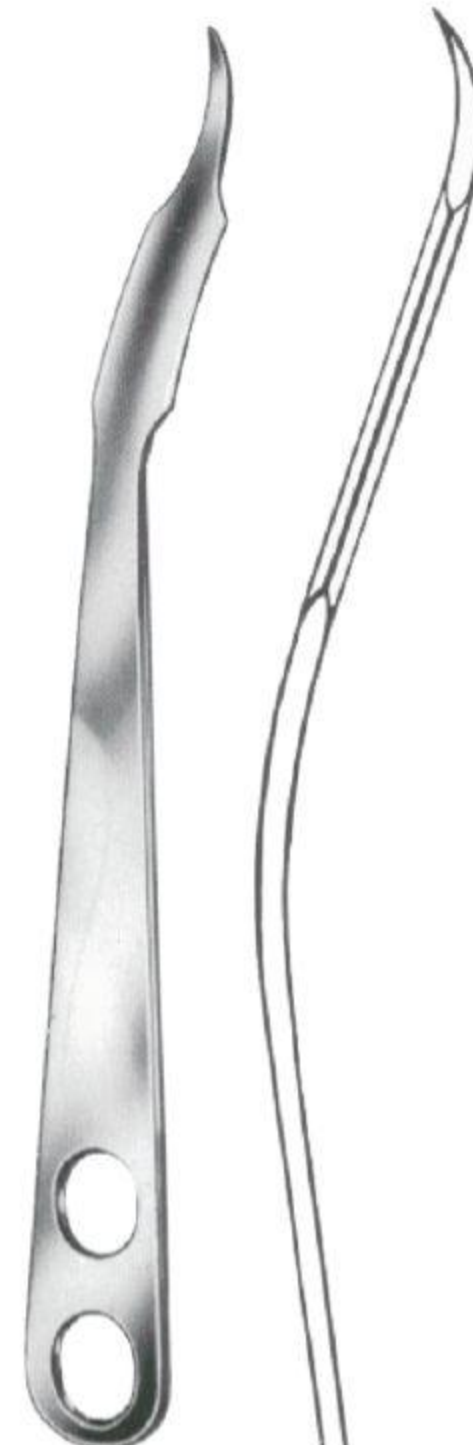

Hohmann
 12-3664-24
 24 cm/9½"
 14mm



Hohmann
12-3665-26
26 cm/10¼"
22 mm

Hohmann
12-3666-28
28 cm/11"
33 mm

Hohmann
12-3667-24
24 cm/9½"
43 mm

Hohmann
12-3668-24
24.5 cm/9¾"
43 mm

Hohmann
12-3669-24
24 cm/9½"
70 mm

Hohmann
12-3670-22
22 cm/8¾"
18 mm



Lange-Hohmann modif
 30 mm 12-3671-26 26.5 cm/10½"
 33 mm 12-3671-29 29.0 cm/11½"

Hohmann-Aldinger
 12-3672-27
 27 cm/10½"

Schumacher (Wagner)
 12-3673-34
 34.5 cm/13½"

Schumacher
 12-3674-29
 29 cm/11½"



Smillie
14 cm/5½"

12-3675-01
32x19 mm

12-3675-02
48x19 mm

12-3675-03
57x19 mm



12-3675-04
52x13 mm



12-3675-05
12x13 mm

Spinal retractors



12-3676-01
75x30 mm

12-3676-02
100x30 mm

Taylor
17 cm/6½"



12-3677-21
21.5 cm/8½"

Meniscus retractors



Blount
12-3678-17
17.5 cm/7"

Bone Levers ●— EN
 Knochenhebel ●— DE
 Elevadores para huesos ●— ES



Murphy-Lane
 12-3679-32
 32 cm/12½"



Chandler

Length	Width	
18 cm	13 mm	12-3680-13
20 cm	19 mm	12-3680-19
23 cm	25 mm	12-3680-23
25 cm	30 mm	12-3680-30



Blount
 12-3681-26
 26 cm/10¼"



Blount
 12-3682-26
 26 cm/10¼"



Bennett 12-3683-44 44 mm
 24 cm/9½" 12-3683-64 64 mm



Smillie
12-3684-17
17 cm/6¾"



Smillie
12-3685-17
17 cm/6¾"



Smillie
12-3686-17
17 cm/6¾"



Salenius
12-3687-22
22 cm/8¾"



Salenius
12-3688-22
22 cm/8¾"



12-3689-17
17.5 cm/7"



Neff
12-3690-21
21.5 cm/8½"



Canad-Modell
12-3691-01 20 cm/8"



12-3692-02



Bircher
12-3693-20
20.5 cm/8"

Drill guide and dura protecting forceps



Adson
 12-3694-15
 15 cm/6"

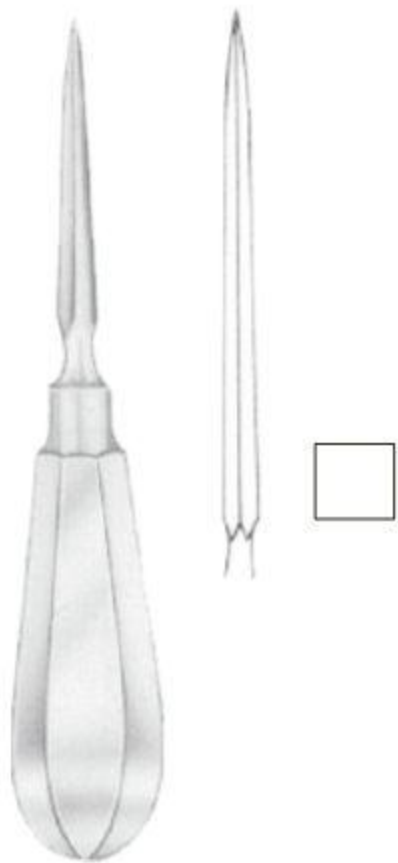

12-3695-14
 14 cm/5½"



Perthes
 12-3696-21
 21 cm/8¼"



12-3697-14
 14 cm/5½"

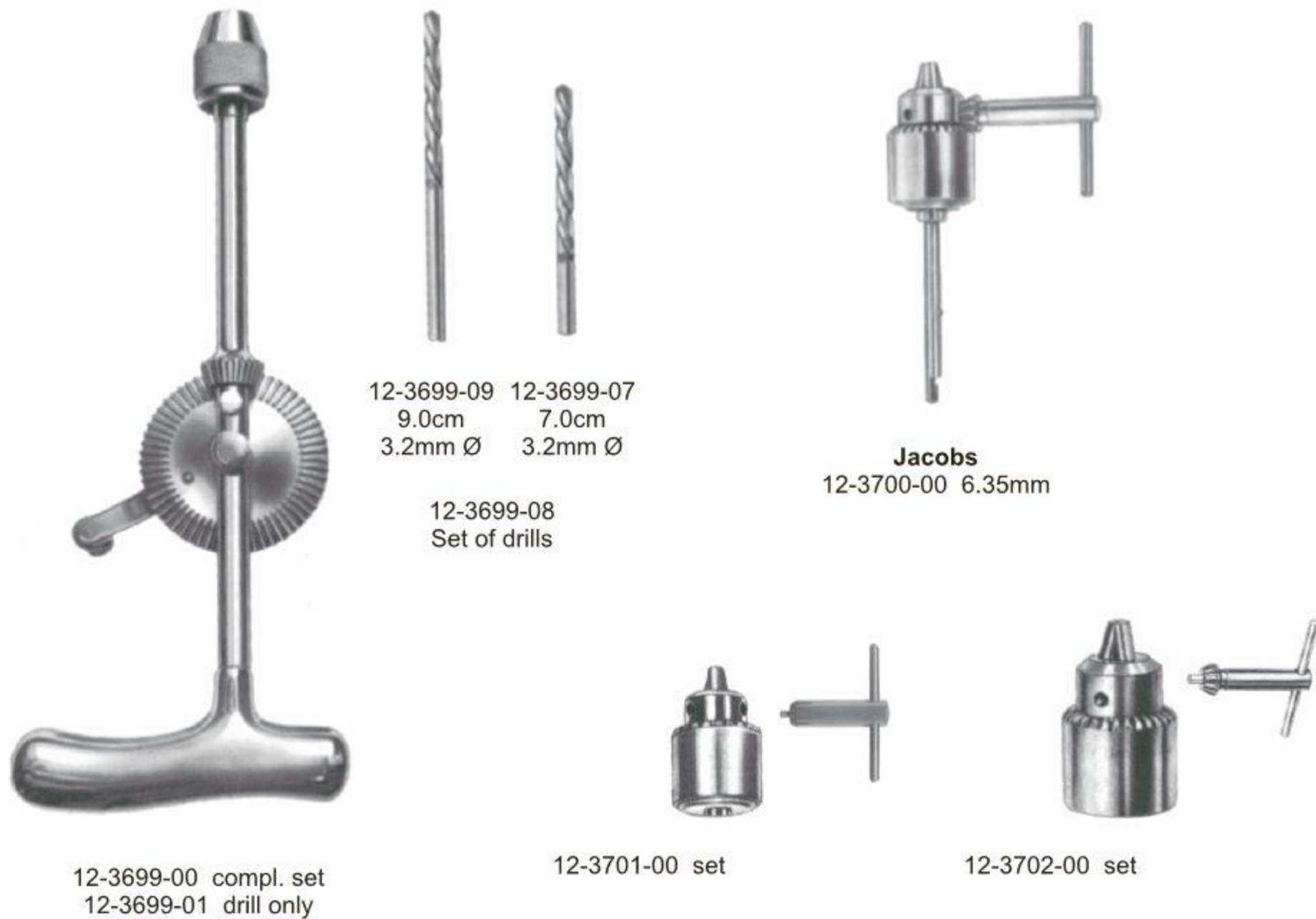
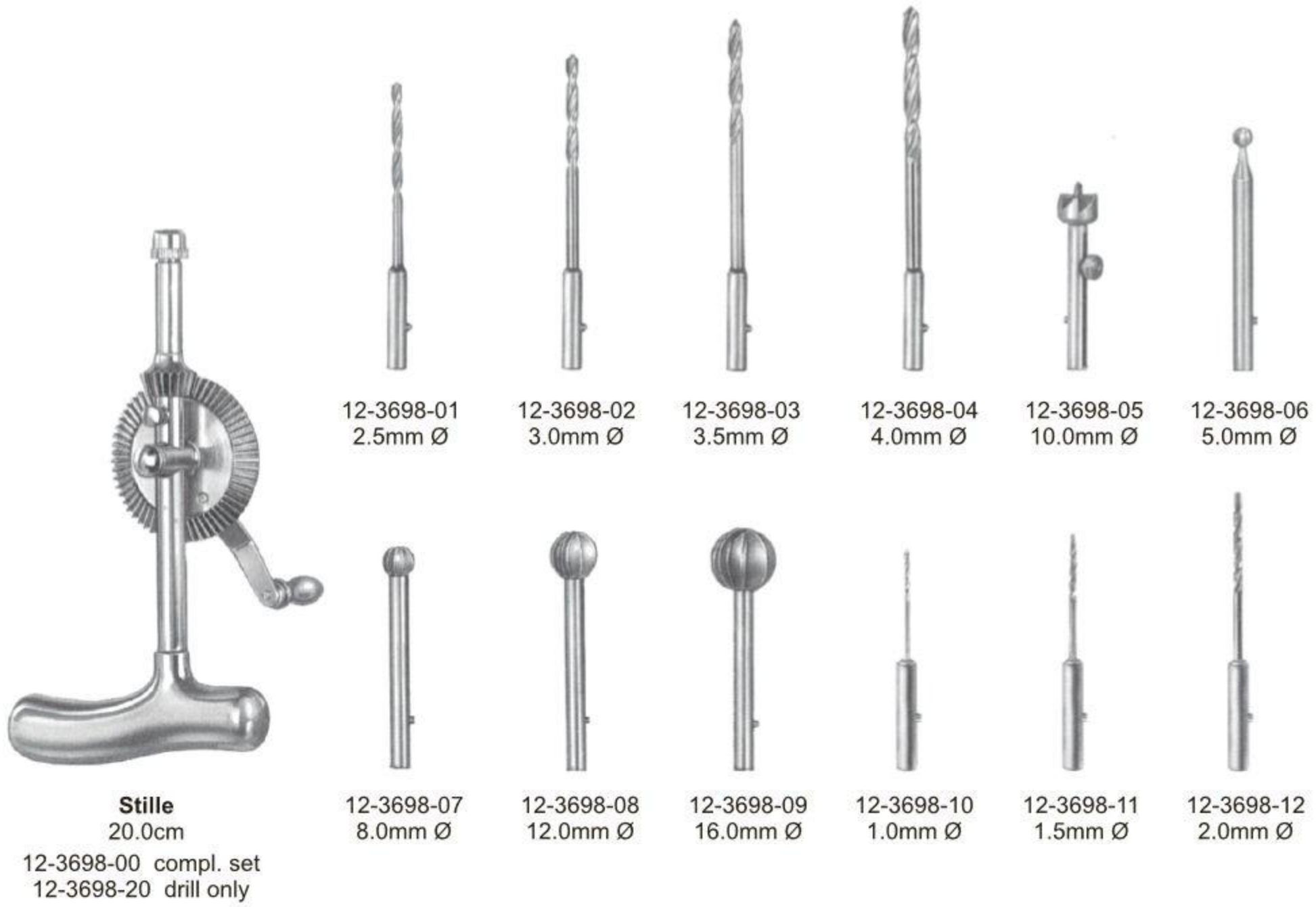



Stille-Sherman
 24.0cm
 12-3703-00 compl. set
 12-3703-24 drill only



12-3703-25 2.5mm Ø
 12-3703-30 3.0mm Ø
 12-3703-35 3.5mm Ø



Hudson
 12-3704-00 compl. set / 6
 (12-3704,01,
 02,03,07,09)
 12-3704-27 handle only



12-3704-01 9mm Ø
 12-3704-02 14mm Ø
 12-3704-03 16mm Ø
 12-3704-04 22mm Ø



Cushing 12-3704-05 14mm Ø
 12-3704-06 2mm Ø
Mckenzie 12-3704-07 13mm Ø
Errico 12-3704-08 16mm Ø
 12-3704-09

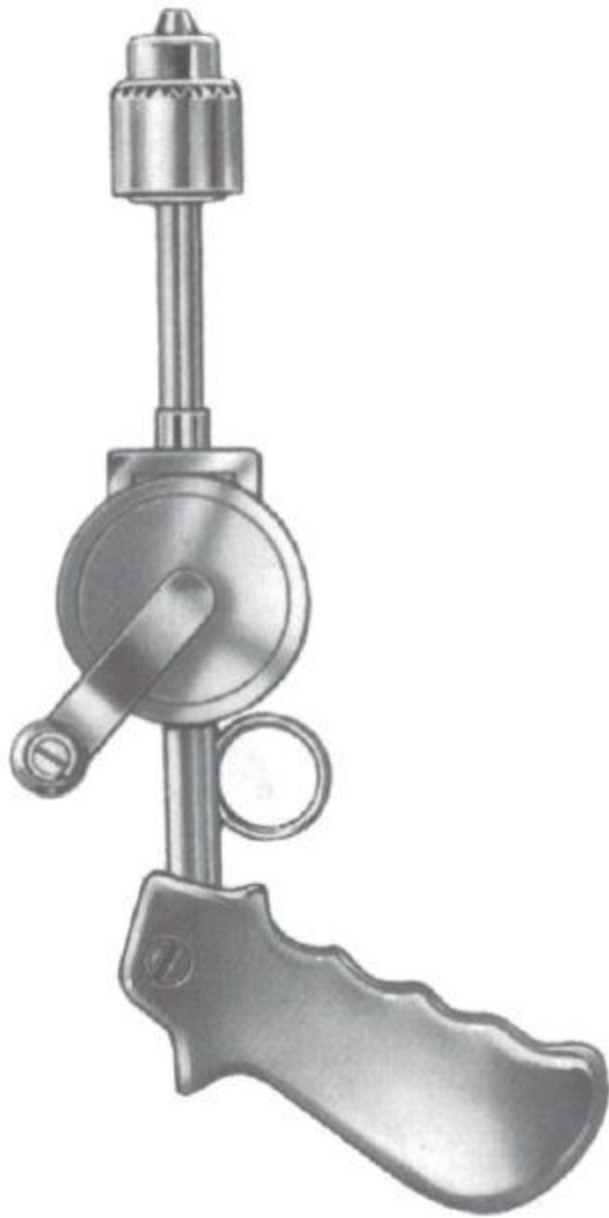

12-3705-00



12-3706-00



12-3707-00



12-3708-01

12-3708-00 complete set



12-3709-01

12-3709-02

12-3709-03

Kirschner
12-3709-00 complete set

Hand Drills ● EN
 Handbohrapparate ● DE
 Perforadores de mano ● ES

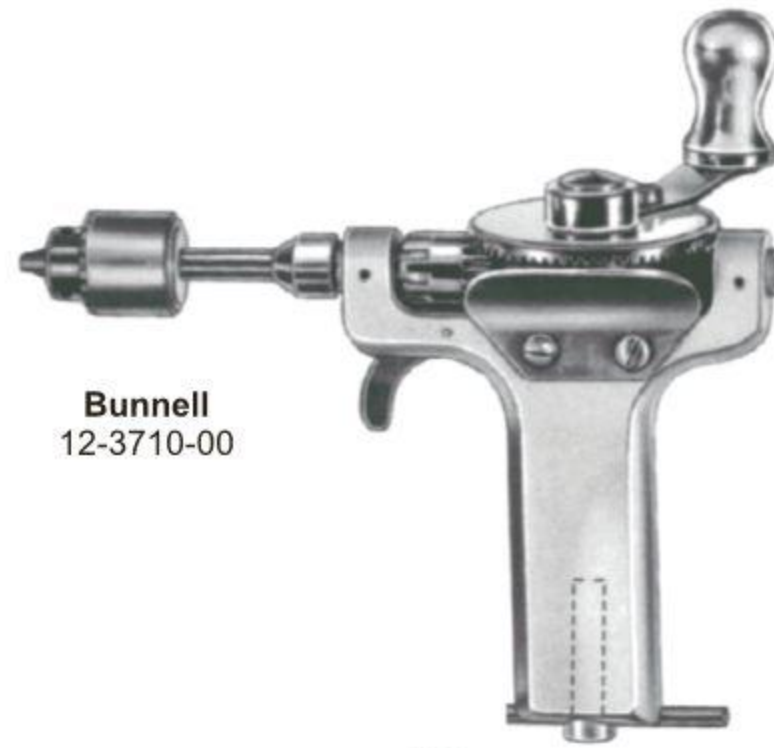

Bunnell
12-3710-00

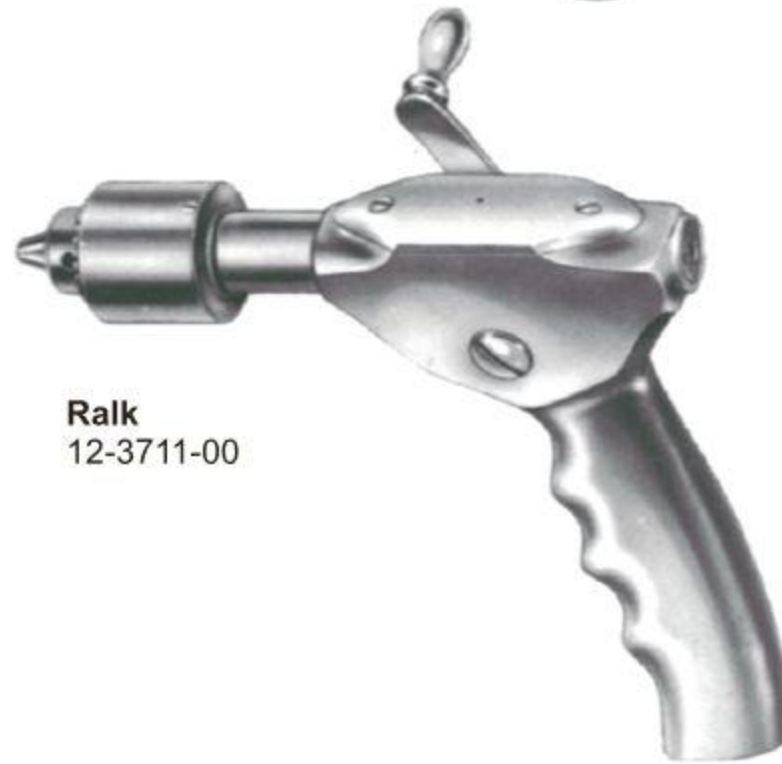

Ralk
12-3711-00

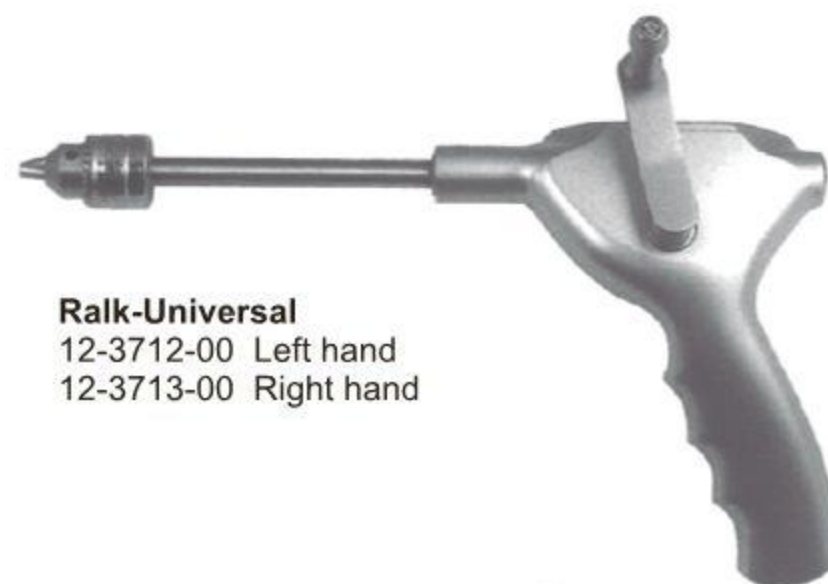

Ralk-Universal
12-3712-00 Left hand
12-3713-00 Right hand



12-3714-00



Spare Saw Blade
12-3715-12 12mm
12-3715-15 15mm
12-3715-18 18mm

Charriere
12-3715-35 35.0cm



Spare Saw Blade
12-3716-03 3mm
12-3716-05 5mm
12-3716-07 7mm

Helferich-Bier
12-3716-39 39.0cm

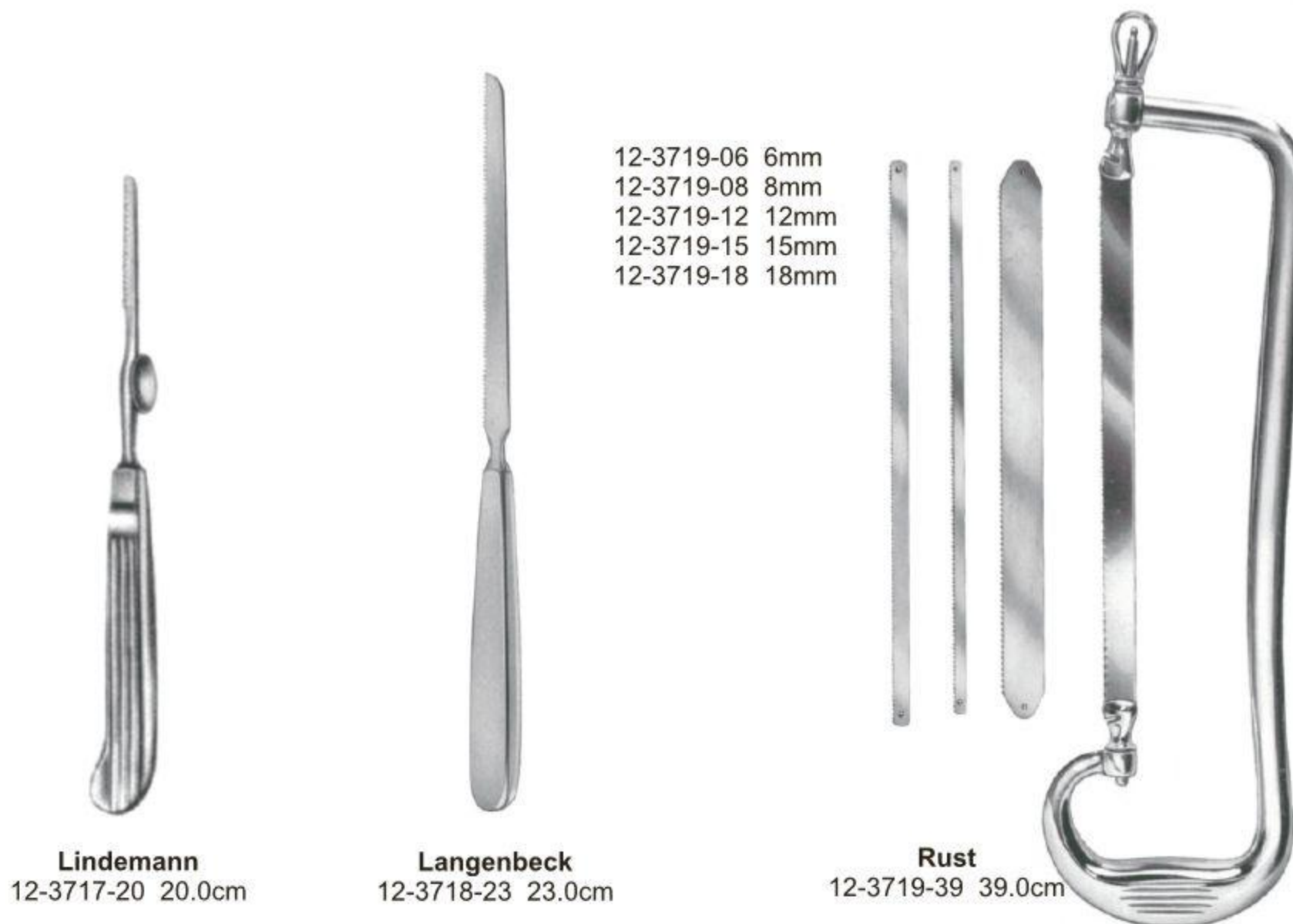

Lindemann
12-3717-20 20.0cm

Langenbeck
12-3718-23 23.0cm

Rust
12-3719-39 39.0cm

12-3719-06 6mm
12-3719-08 8mm
12-3719-12 12mm
12-3719-15 15mm
12-3719-18 18mm



Charriere
 12-3720-27 27.0cm
 12-3720-30 30.0cm
 12-3720-34 34.0cm



Satterlee
 12-3721-31 31.0cm



Charriere
 12-3722-27 27.0cm
 12-3722-30 30.0cm



Satterlee
 12-3723-31
 31.0cm



12-3724-23
 23.0cm

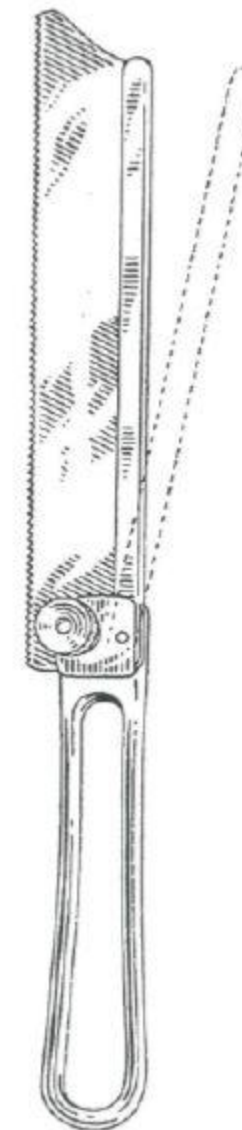

12-3725-19
 19.0cm

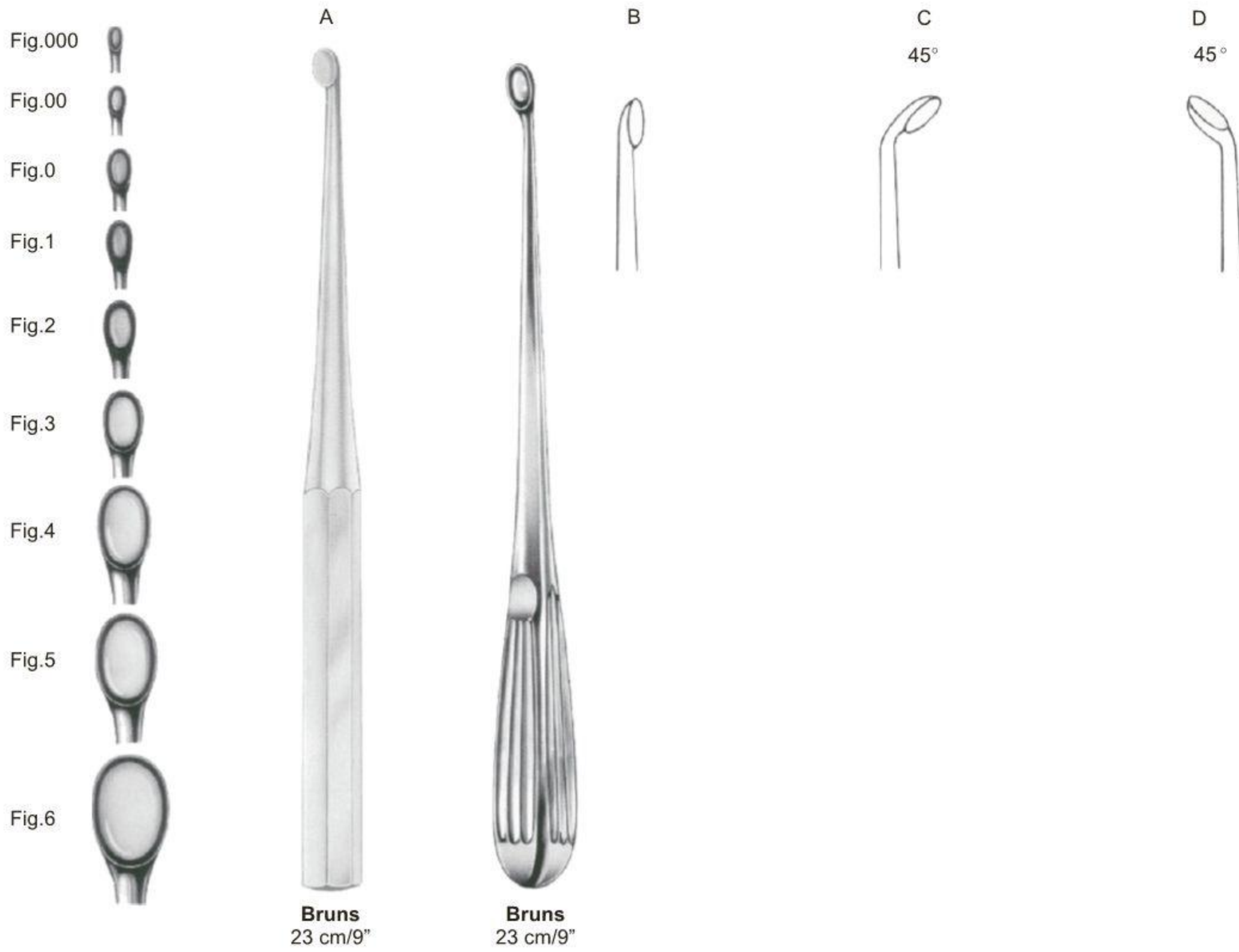

Fig.	A	B	C	D
000	12-3726-30	12-3727-30	12-3728-30	12-3729-30
00	12-3726-20	12-3727-20	12-3728-20	12-3729-20
0	12-3726-10	12-3727-10	12-3728-10	12-3729-10
1	12-3726-01	12-3727-01	12-3728-01	12-3729-01
2	12-3726-02	12-3727-02	12-3728-02	12-3729-02
3	12-3726-03	12-3727-03	12-3728-03	12-3729-03
4	12-3726-04	12-3727-04	12-3728-04	12-3729-04
5	12-3726-05	12-3727-05	12-3728-05	12-3729-05
6	12-3726-06	12-3727-06	12-3728-06	12-3729-06

Bone Curettes ●— EN
 Scharfe Löffel ●— DE
 Cucharillas cortantes ●— ES



Volkmann
 17 cm/6¾"



- Fig.
 0000 12-3730-40
 000 12-3730-30
 00 12-3730-20
 0 12-3730-10
 1 12-3730-01
 2 12-3730-02
 3 12-3730-03
 4 12-3730-04
 5 12-3730-05
 6 12-3730-06



Volkmann
 17 cm/6¾"

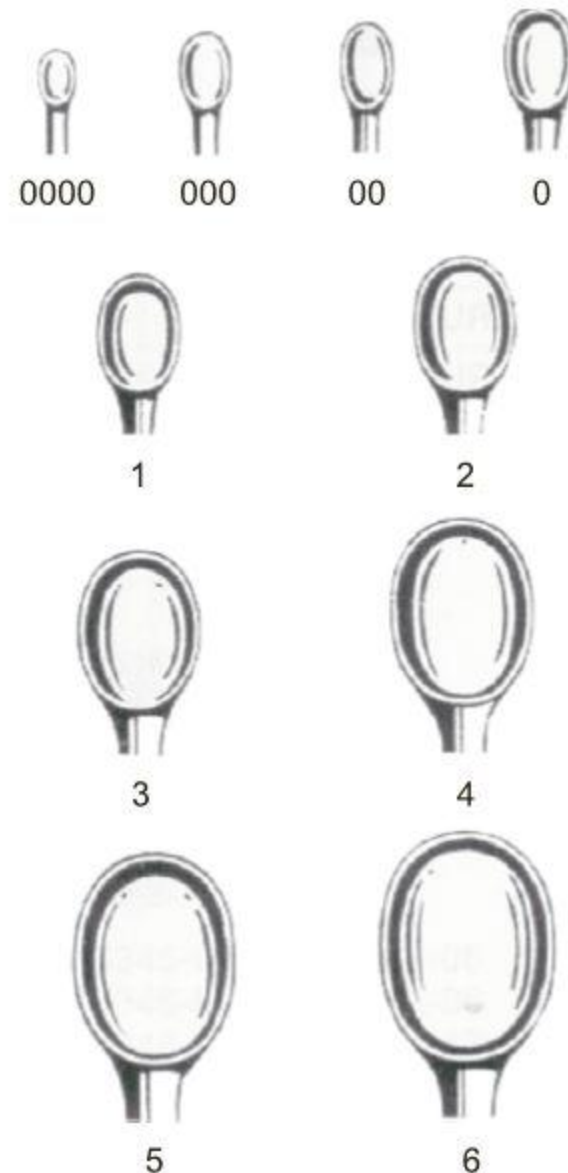

- Fig.
 0000 12-3731-40
 000 12-3731-30
 00 12-3731-20
 0 12-3731-10
 1 12-3731-01
 2 12-3731-02
 3 12-3731-03
 4 12-3731-04
 5 12-3731-05
 6 12-3731-06

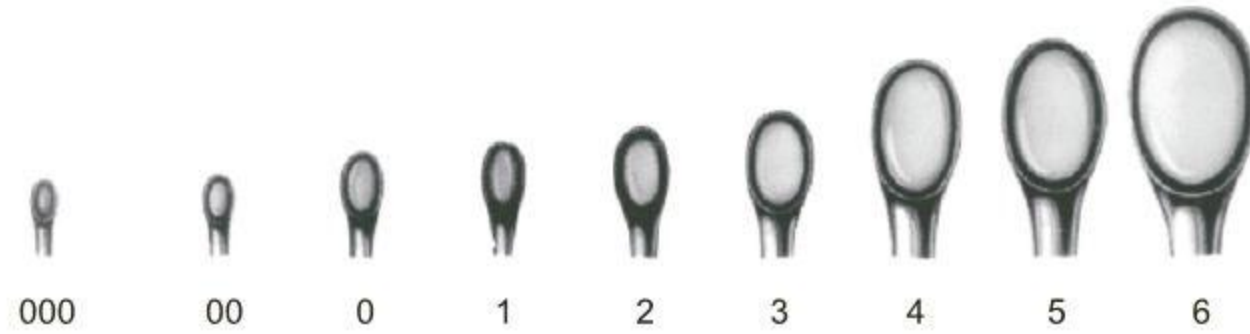

12-3732-21
21 cm/8 1/4"



Epstein



Spinal



Spinal

Fig.			
000	12-3733-30	12-3734-30	12-3735-30
00	12-3733-20	12-3734-20	12-3735-20
0	12-3733-10	12-3734-10	12-3735-10
1	12-3733-01	12-3734-01	12-3735-01
2	12-3733-02	12-3734-02	12-3735-02
3	12-3733-03	12-3734-03	12-3735-03
4	12-3733-04	12-3734-04	12-3735-04
5	12-3733-05	12-3734-05	12-3735-05
6	12-3733-06	12-3734-06	12-3735-06
	20 cm/8"	20 cm/8"	20 cm/8"

Bone Currettes ●— EN
 Scharfe Löffel ●— DE
 Cucharillas cortantes ●— ES



	Volkmann		Volkmann	
Length	Oval/Oval		Oval/Round	
cm	in			
13	5"	12-3736-13	12-3737-13	
14	5½"	12-3736-14		
16	6¼"		12-3737-16	
17	6¾"	12-3736-17		
20	8"	12-3736-20	12-3737-20	



Martini
 13.5 cm/5"



Jansen
 12-3739-15
 15 cm/6"



Jansen
 12-3740-16
 16 cm/6¼"



Williger
 13.5 cm/5"



Jacobson
 12-3742-13
 13 cm/5"



Janson
 12-3743-15
 15 cm/6"



Barth
 12-3744-18
 18 cm/7"



Schede
17 cm/6¾"

Fig.	
000	12-3745-30
00	12-3745-20
0	12-3745-10
1	12-3745-01
2	12-3745-02
3	12-3745-03
4	12-3745-04



Williger
17.5 cm/7"

	00	00
	0	0
	1	1
	2	2
Straight, Oval		Straight
12-3746-20	Fig. 00	12-3747-20
12-3746-10	0	12-3747-10
12-3746-01	1	12-3747-01
12-3746-02	2	12-3747-02

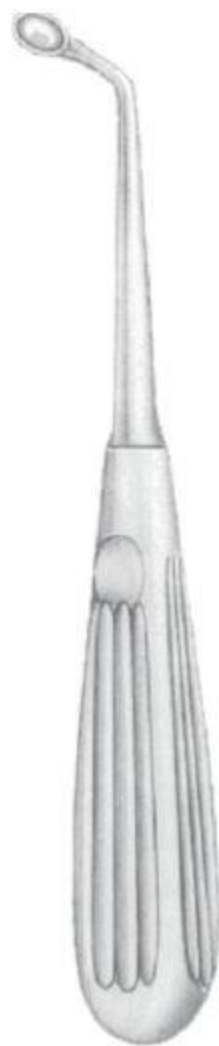

12-3748-01

Uffendorde
17 cm/6¾"

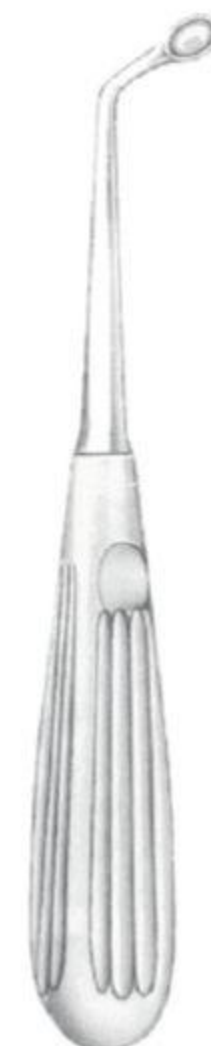

12-3749-02



Bruns	Fig.	Spratt
12-3750-30	000	12-3751-30
12-3750-20	00	12-3751-20
12-3750-10	0	12-3751-10
12-3750-01	1	12-3751-01
12-3750-02	2	12-3751-02
12-3750-03	3	12-3751-03
12-3750-04	4	12-3751-04
12-3750-05	5	12-3751-05
12-3750-06	6	12-3751-06

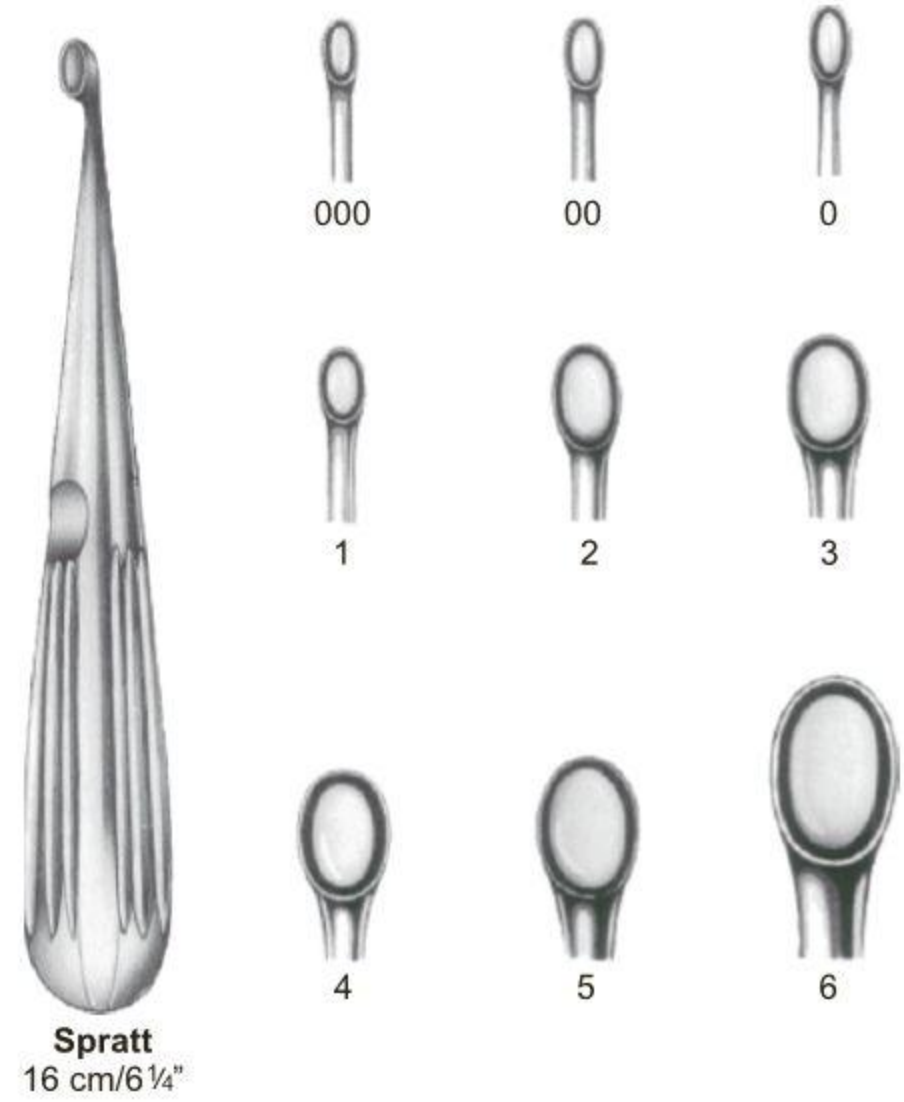

mm	Round	Oval
2	12-3752-02	12-3753-02
3	12-3752-03	12-3753-03
4	12-3752-04	12-3753-04
5	12-3752-05	12-3753-05
6	12-3752-06	12-3753-06
7	12-3752-07	12-3753-07
8	12-3752-08	12-3753-08
10	12-3752-10	12-3753-10
12	12-3752-12	12-3753-12
14	12-3752-14	12-3753-14
	17cm/6¾"	22cm/8½"

Flexible

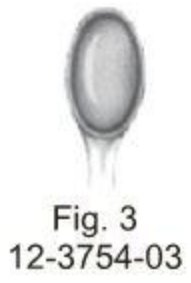

Bone Currettes ●— EN
 Scharfe Löffel ●— DE
 Cucharillas cortantes ●— ES



Volkmann
 27 cm/10½"



Simon
 24 cm/9½"



Simon
 24 cm/9½"



Daubenspeck
 20 cm/8"



Martin
12-3762-19
19 cm/7½"



Preston
12-3763-18
18 cm/7¼"

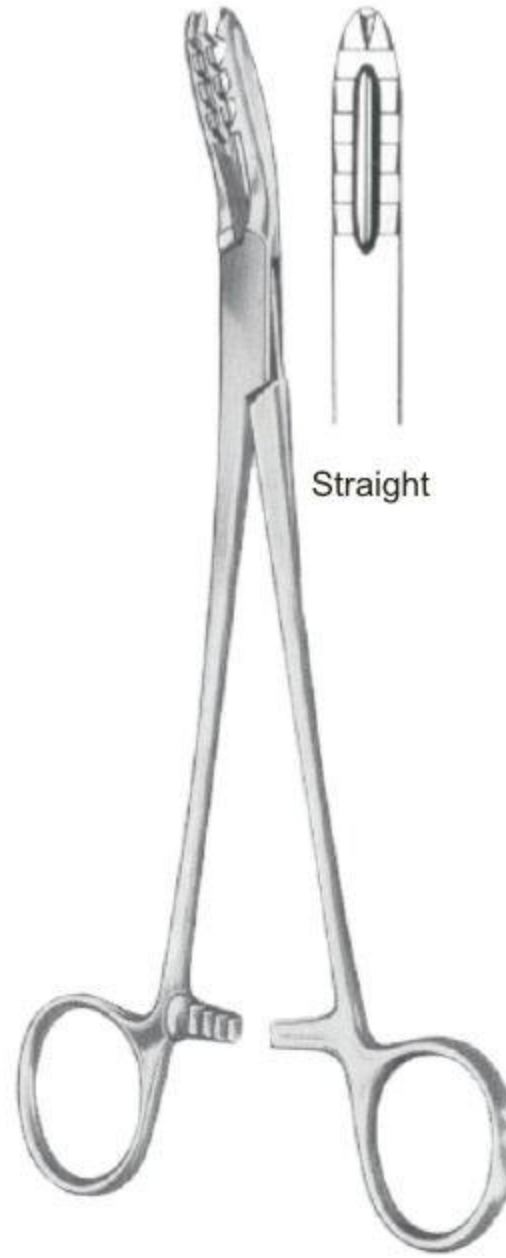

Bircher-Ganske
12-3764-20
20 cm/8"

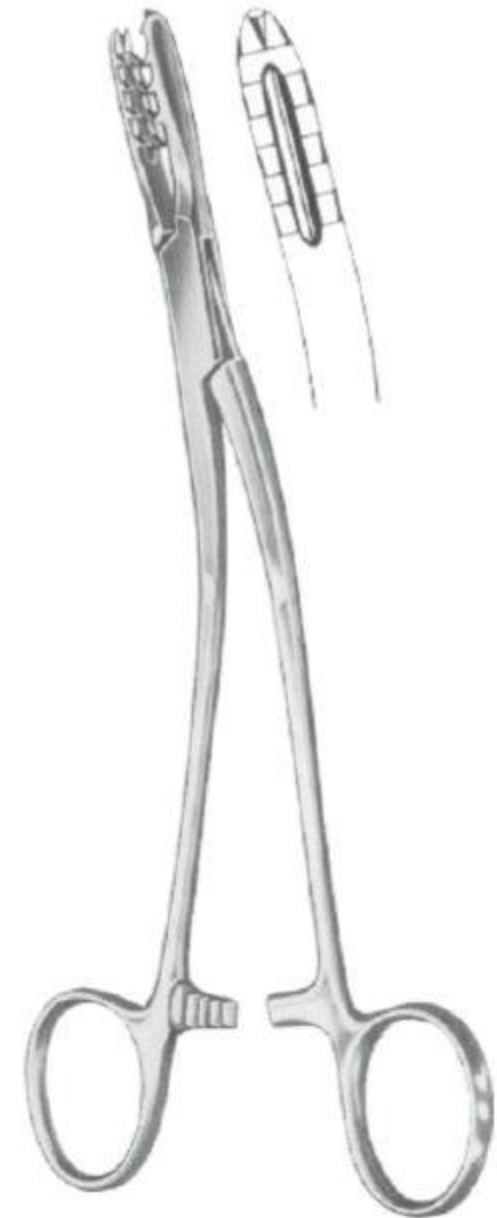

Bircher-Ganske
12-3765-20
20 cm/8"



Lewin
12-3766-17
17.5 cm/7"



Langenbeck
12-3767-21
21 cm/8 "



Fergusson
12-3768-21
21 cm/8 "

Bone Holding Forceps ● EN
 Knochenhaltezaugen ● DE
 Pinzas para huesos ● ES



Straight
 12-3769-20
 20 cm/8"



Curved on Falt
 12-3770-20
 20 cm/8"



Van Buren
 12-3771-23
 23 cm/9"



Dingmann
 12-3772-19
 19cm/7½"



Dingmann Modif
 12-3773-19
 19 cm/7½"



Neff
 12-3774-21
 21 cm/8¼"



Semb
12-3775-19
19 cm/7½"



Semb
12-3776-19
19 cm/7½"



Verbrugge
12-3777-17
17.5 cm/7"

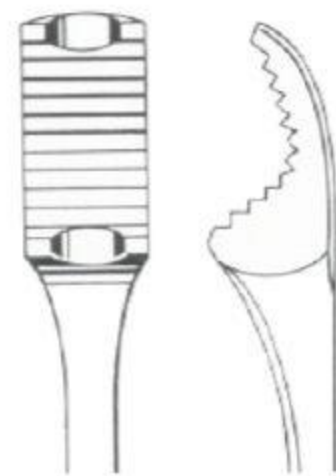

12-3778-25
25 cm/10"

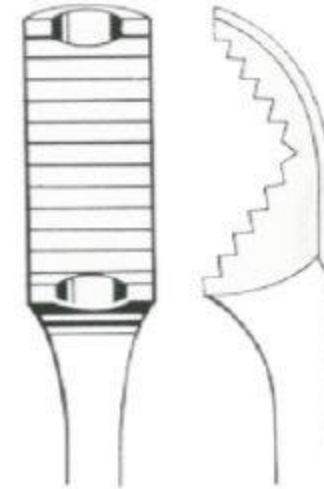

12-3779-26
26 cm/10¼"
Verbrugge

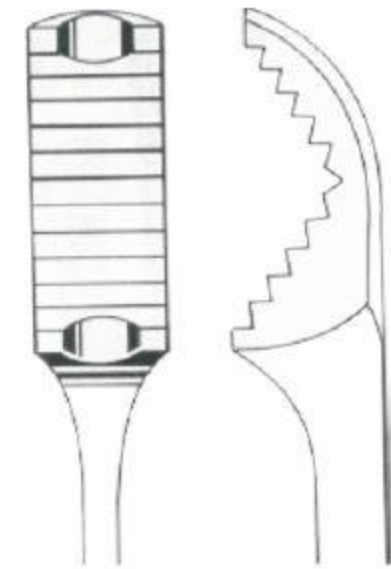

12-3780-27
27 cm/10½"



12-3781-16
16 cm/6¼"
12-3781-24
24 cm/9½"



Without Ratchet	Kern		With Ratchet
	cm	in	
12-3782-17	17	6¾"	12-3783-17
12-3782-21	21	8¼"	12-3783-21



12-3784-18	18 cm/07"	12-3785-18
12-3784-23	23 cm/09"	12-3785-23
12-3784-25	25 cm/10"	12-3785-25
12-3784-28	28 cm/11"	12-3785-28



Hey Groves
12-3786-21 21.0 cm/8¼"
12-3786-27 27.0 cm/10½"
12-3786-30 30.5 cm/12"



Farabeuf-Lambotte
12-3787-26
26 cm/10¼"



Lambotte
12-3788-19 19 cm/7½"
12-3788-23 23 cm/9"
12-3788-26 26 cm/10¼"



Without Ratchet	Lane	With Ratchet
	cm in	
12-3789-33	33 13"	12-3790-33
12-3789-45	45 17¾"	12-3790-45



12-3791-14
14.5 cm/5¾"



12-3792-12
12 cm/4¾"



12-3793-15 15 cm/6"
 12-3793-19 19 cm/7 1/2"
 12-3793-24 24 cm/9 1/2"
 12-3793-26 26 cm/10 1/4"
 12-3793-28 28 cm/11"



Handles Detachable

Percy
 12-3794-30

Adjustable



Lambotte
 12-3795-22 22 cm/8 3/4"
 12-3795-27 27 cm/10 1/2"
 12-3795-30 30 cm/12"



Farabeuf
 12-3796-23 23 cm/9"
 12-3796-26 26 cm/10 1/4"



Lambotte
 12-3797-22 22.5 cm/9"
 12-3797-25 25.5 cm/10 1/2"
 12-3797-33 33 cm/13 1/2"



Stellbrink
17.5 cm/7"



Bane-Hartmann
12-3800-17
17.5 cm/7"



Mini-Friedmann
12-3801-12
12.5 cm/5"



Friedmann
12-3802-14
14 cm/5½"

Bone Holding Forceps, Bone Holding Clamps ●— EN

Knochenhaltezaugen, Knochenhalteklammern ●— DE

Pinzas para huesos, Pinzas porta-huesos ●— ES



12-3803-13
13.5 cm/5¼"



12-3804-20
20 cm/8"



12-3805-17
17 cm/6¾"



Patella Forceps

12-3806-17
17.5 cm/7"



Lowman-Hoglund
12-3807-19
19 cm/7½"



Lowman
12-3808-18 18 cm/7"
12-3808-20 20 cm/8"
12-3808-22 22 cm/8¾"



Lowman
12-3809-12
12 cm/4¾"

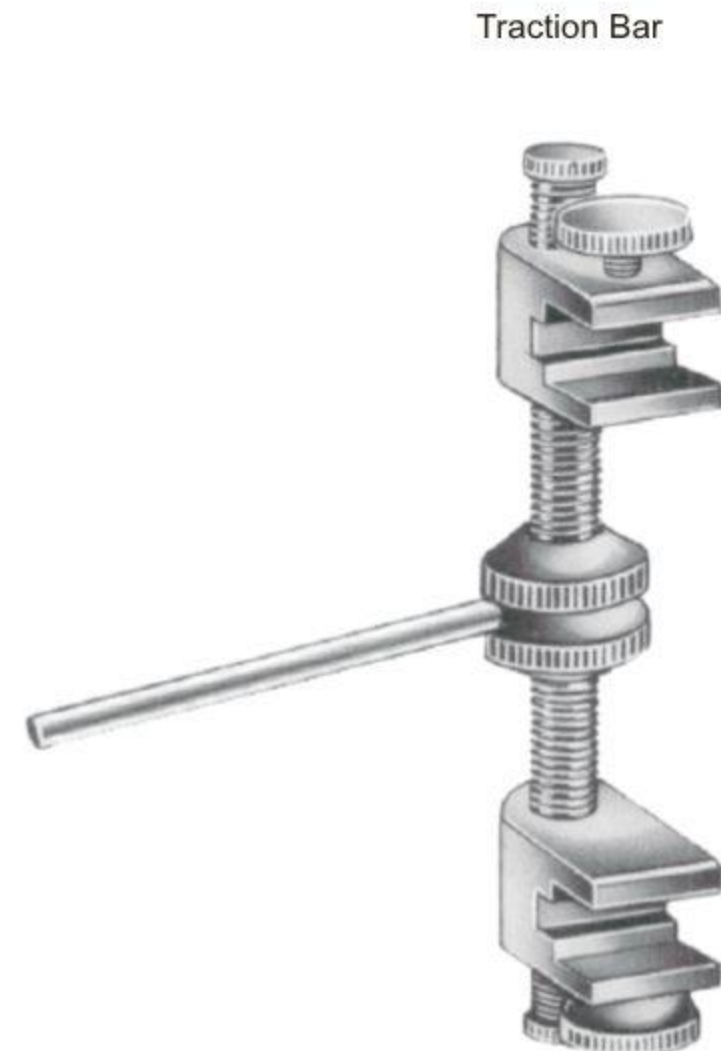

Traction Bar

12-3810-18
12-3810-50

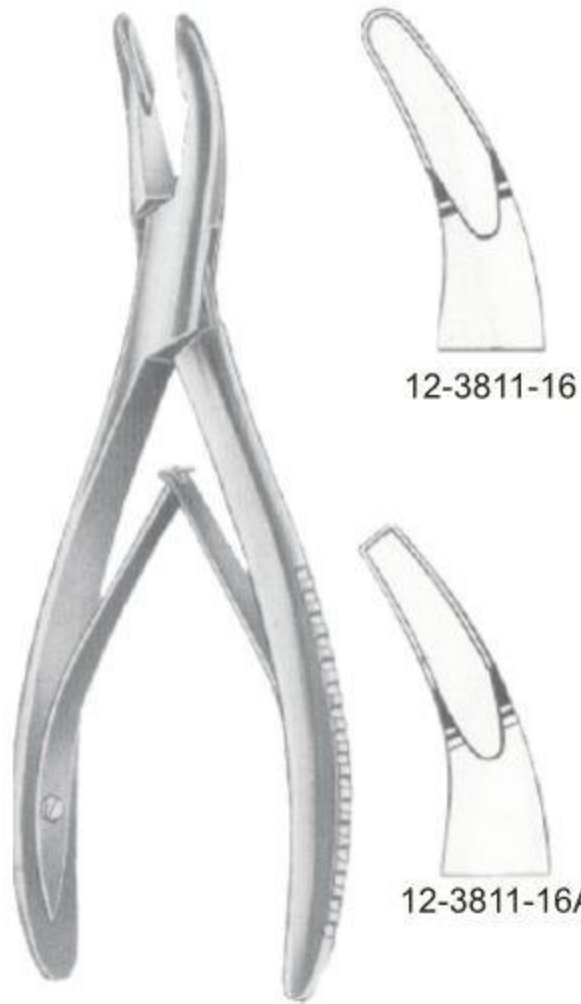

Mead
16.5 cm/6½"

12-3811-16

12-3811-16A



	Lempert	
Straight	cm in	Curved
12-3812-16	16 6¼"	12-3813-16
12-3812-19	19 7½"	12-3813-19



Beyer
12-3814-18
18 cm/7"



Jansen
17.5 cm/7"

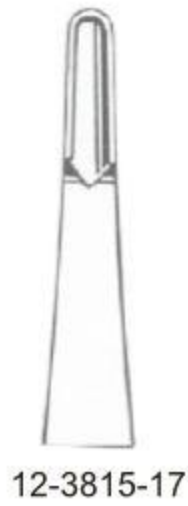

Blumenthal
15.5 cm/6"

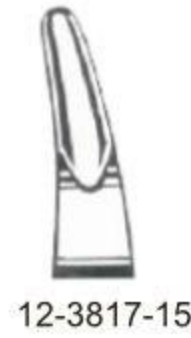

Hakansson
12-3820-15
15.5 cm/6"



Friedmann-Delicate
 15 cm/6"

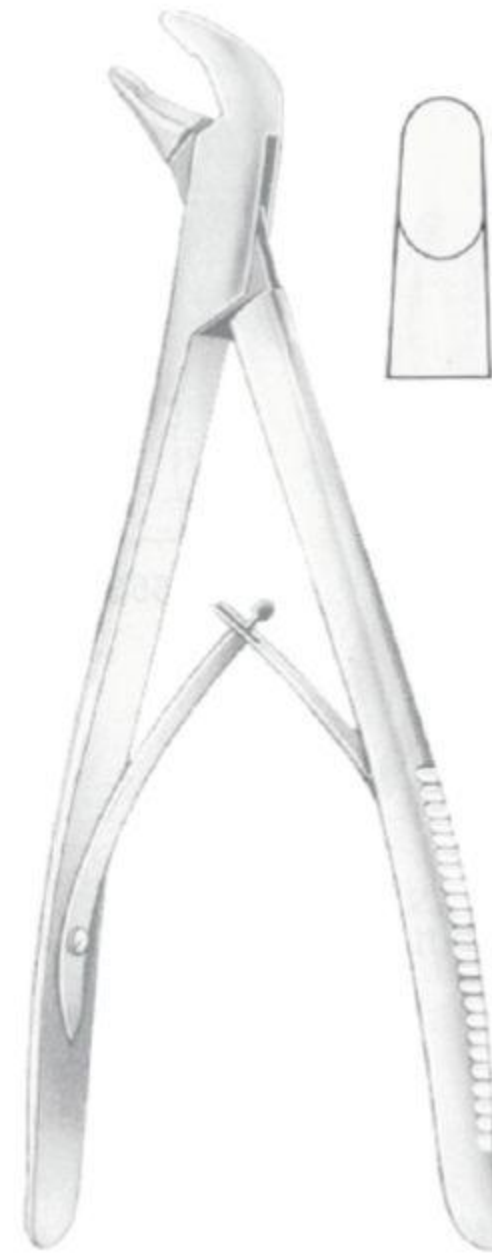

Bacon
 12-3823-20
 20 cm/8"

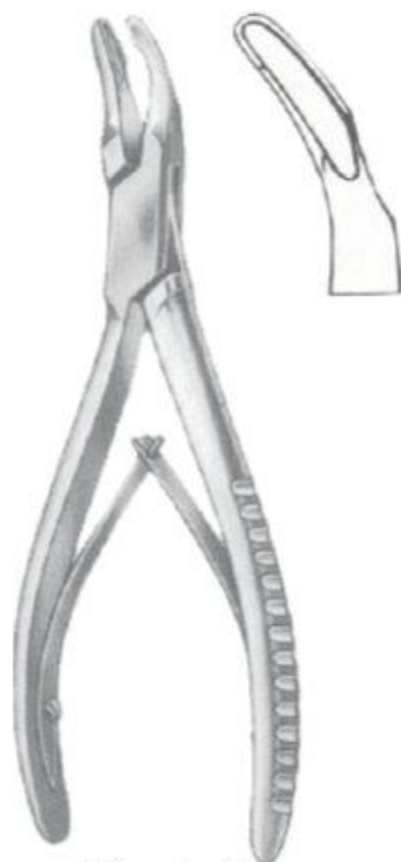

Cleveland
 12-3824-14 14 cm/5½"
 12-3824-17 17 cm/6¾"



Hartmann
 12-3825-18
 18.5 cm/7¼"



Olivecrona
 12-3826-20
 20 cm/8"



Kleinert-Kutz
15 cm/6"



12-3827-15
2 mm



12-3828-15
3 mm



Bohler
15 cm/6"



12-3829-15



12-3830-15



**Beyer
Zaufal-Jansen**
18 cm/7"



Zaufal-Jansen
12-3831-18



Beyer
12-3832-18



Mayfield
12-3833-17
17 cm/6¾"



Ruskin
12-3834-18
18 cm/7"
Angled



Straight
12-3835-18
18 cm/7"
12-3835-23
23 cm/9"



Ruskin

Curved
12-3836-18
18 cm/7"
12-3836-23
23 cm/9"



Jansen
 12-3837-18
 18 cm/7"



Straight
 12-3838-17

Curved
 12-3839-17

Luer
 17 cm/6¾"



Heavy Pattern

Luer
 18.5 cm/7¼"

Straight
 12-3840-18

Curved
 12-3841-18



Luer
 15 cm/6"



12-3842-15



12-3843-15



12-3844-15



Adson
 20 cm/8"

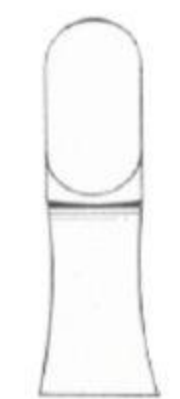

12-3845-20



Stille-Luer
22 cm/8¾"

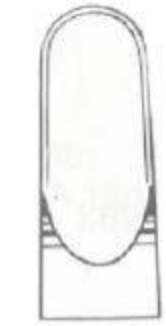

Straight
12-3846-22



Curved
12-3847-22



Stille-Luer
27 cm/10½"



12-3848-27



12-3849-27



Semb
12-3850-23
23 cm/9"

Bone Rongeur Forceps ● EN
 Hohlmeißelzangen ● DE
 Pinzas-gubias ● ES



Marquardt
 12-3851-20
 20 cm/8"



Rottgen-Ruskin
 12-3852-24
 24 cm/9½"



12-3853-03
 3 mm



12-3853-04
 4 mm



12-3853-05
 5 mm



12-3853-03A
 3 mm



12-3853-04A
 4 mm



12-3853-05A
 5 mm



Smith-Petersen
 24 cm/9½"



Markwalder
12-3854-20
20 cm/8"



Straight cm
12-3855-14 14
12-3855-17 17
12-3855-19 19
12-3855-22 22



Liston in **Curved**
5½ 12-3856-14
6¾ 12-3856-17
7½ 12-3856-19
8¾ 12-3856-22



Littauer-Liston
12-3857-15
15 cm/6"



Cleveland
12-3858-15 15 cm/6"
12-3858-17 17 cm/6¾"



Bohler
15 cm/6"



McIndoe
12-3861-17
17.5 cm/7"

Bone Rongeur Forceps ● EN
 Hohlmeißelzangen ● DE
 Pinzas-gubias ● ES

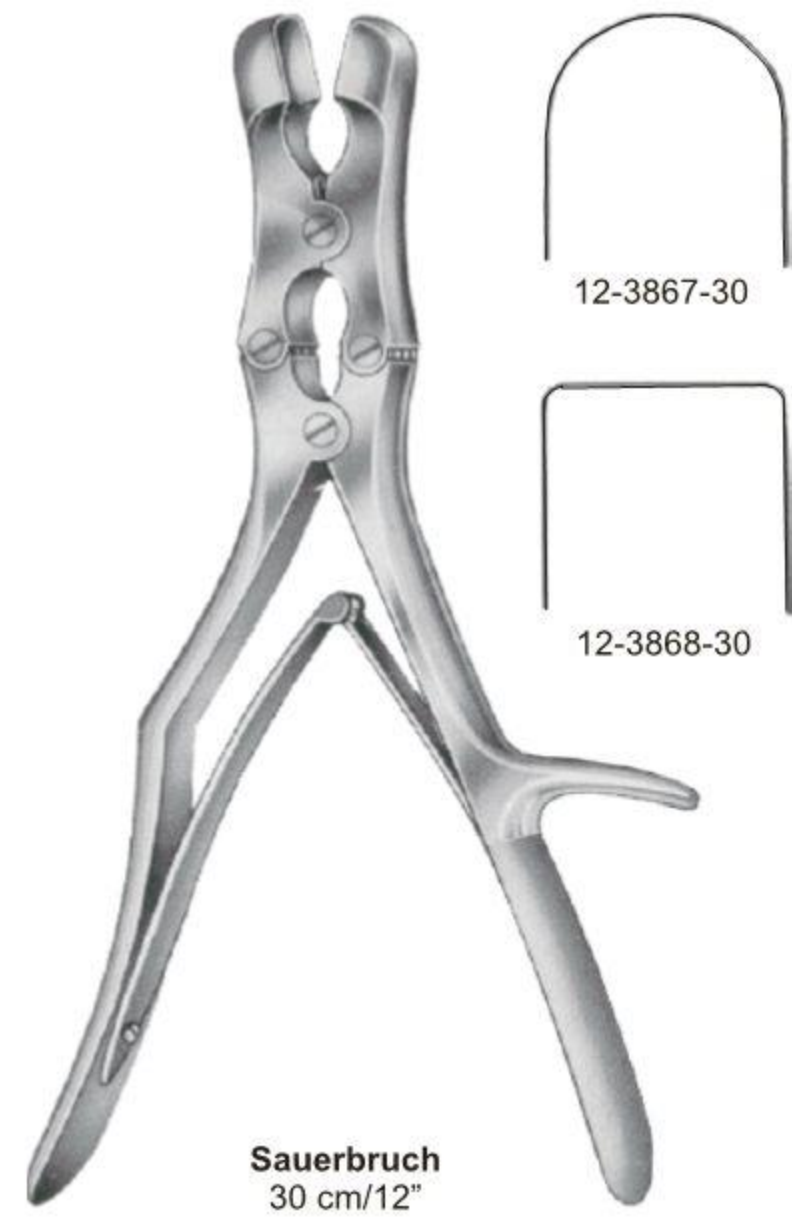

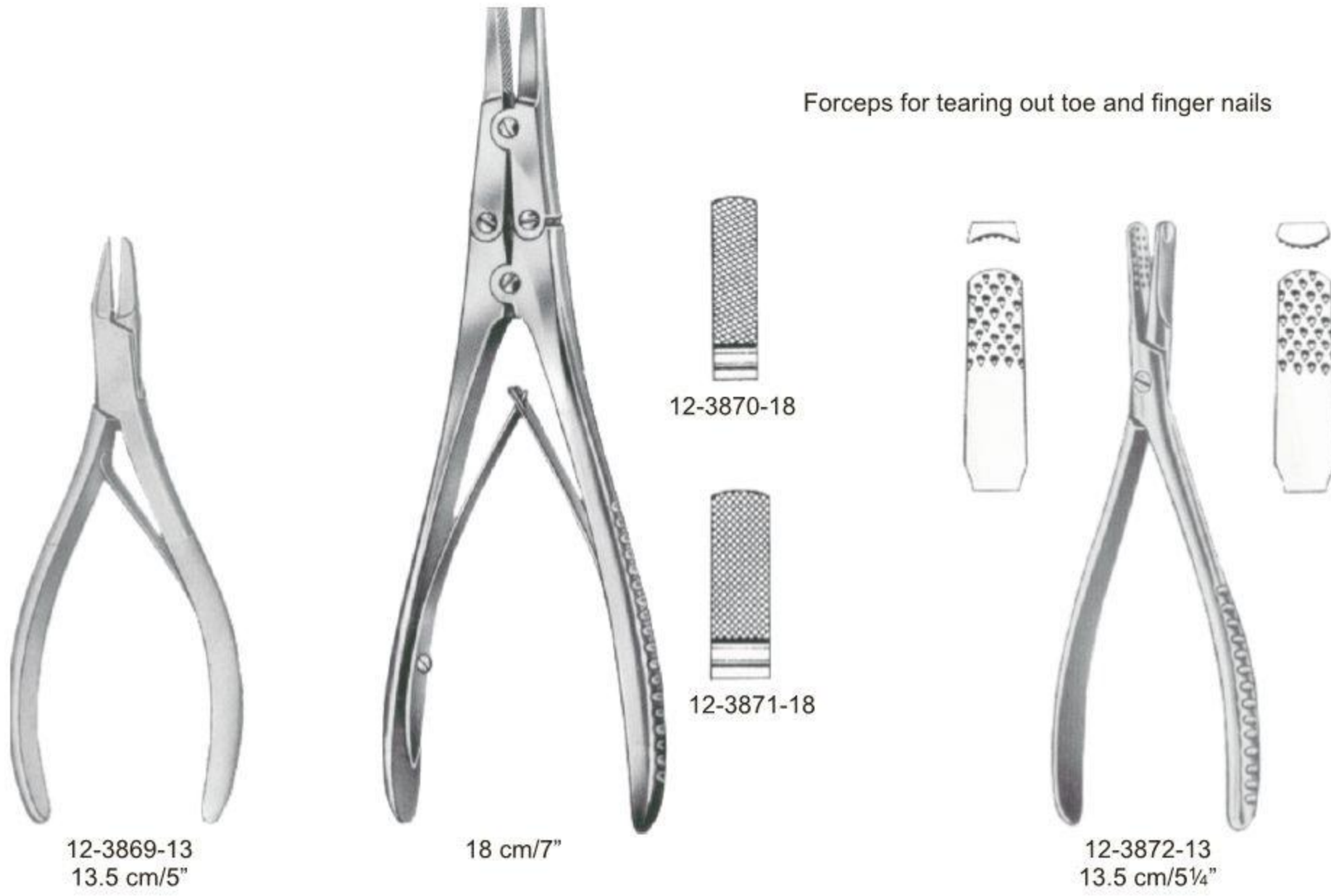



Kazanjian
 12-3875-18
 18 cm/7"



Ruskin-Liston
 18.5 cm/7 1/4"



Straight
 12-3876-18



Curved on flat
 12-3877-18



Stille-Liston
 23 cm/9"
 27 cm/10 1/2"

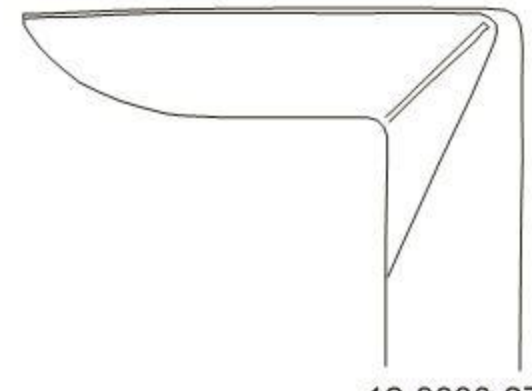

12-3880-27
 27 cm/10 1/2"

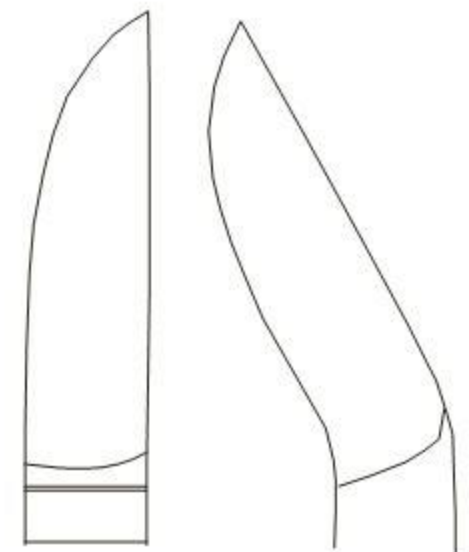

12-3878-23
 12-3878-27

12-3879-23
 12-3879-27



Liston-Key(Horsley)
 12-3881-27
 27 cm/10 1/2"



Semb
 12-3882-24
 24 cm/9 1/2"



12-3883-13 13 cm/5"
12-3883-18 18 cm/7"



12-3884-17
17 cm/6¾"

TC

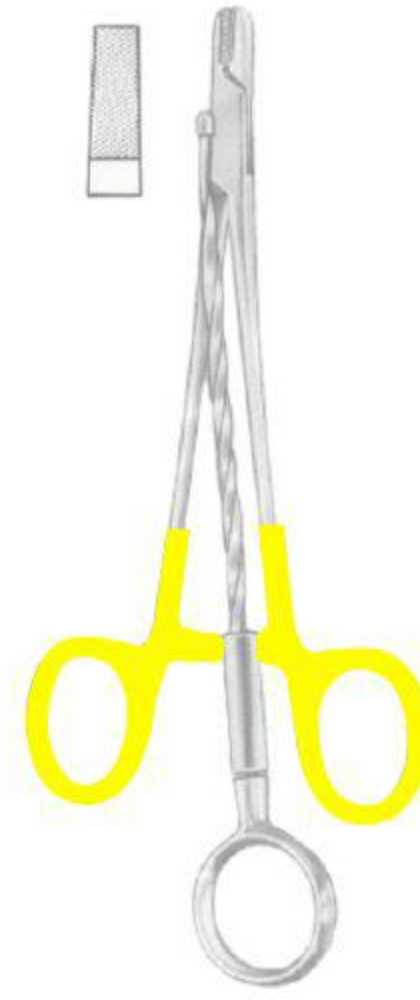

12-3885-15
15.5 cm/6"



12-3886-17 17 cm/6¾" 12-3887-17

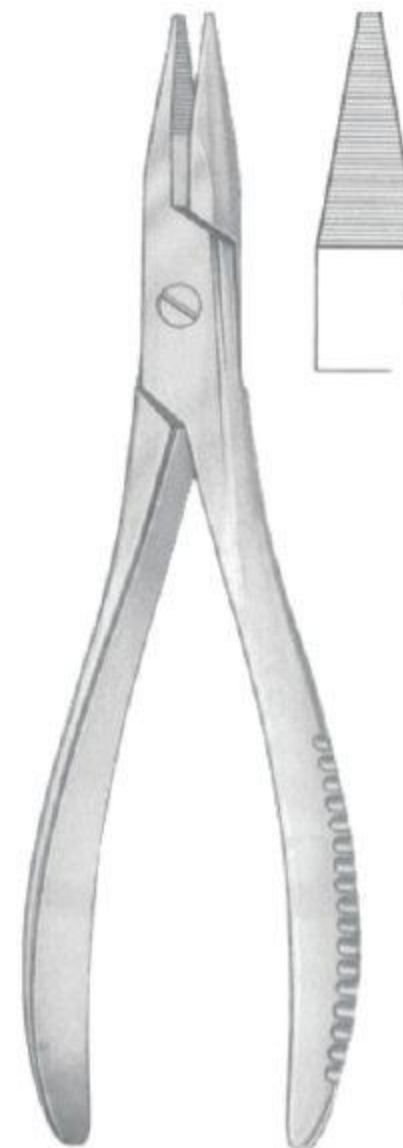

12-3888-19
19 cm/7½"

Wire Seizing Forceps ●— EN
 Faßzangen ●— DE
 Pinzas para coger ●— ES



12-3889-14
 14 cm/5½"



12-3890-16
 16 cm/6¼"



18cm/7"



12-3891-01

TC



12-3891-02



12-3891-03

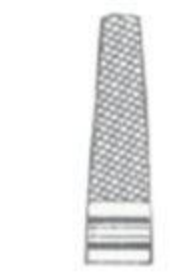

12-3891-04



12-3891-05

TC



12-3892-18 18 cm/7"
 12-3892-20 20 cm/8"



12-3893-16
 15 cm/6"

12-3893-20
 20 cm/8"

TC



12-3894-16
 15 cm/6"



For soft wire
with a diam. of max.

12-3895-15
15 cm/6"
2.0 mm

12-3896-18
18.5 cm/7¼"
1.7 mm

12-3897-16
16 cm/6¼"
2.0 mm

For hard wire
with a diam. of max.

1.5 mm

1.7 mm

2.0 mm

TC



12-3898-12
 0.7 mm
 0.5 mm
 12 cm/4¾"



12-3899-15
 2.0 mm
 1.0 mm
 15 cm/6"



12-3900-18
 2.0 mm
 1.7 mm
 18 cm/7"



212-3901-18
 2.5 mm
 1.5 mm
 18.5 cm/7¼"



12-3902-18
 2.0 mm
 1.7 mm
 18 cm/7"



12-3903-22
 3.0 mm
 2.5 mm
 22 cm/8¾"



12-3904-22
 3.0 mm
 22 cm/8¾"

Screw Nut Wrench



12-3905-10
10 cm/4"

Screw Driver



12-3906-12
12 cm/4 3/4"

Wire Strainer



12-3907-20
20 cm/8"

Fixation Discs For Drill Wires



12-3908-30
Pair



12-3909-40



12-3910-42

Fixation Discs



12-3911-51
Pair



With 1 Pin

Bohler

cm	in	
h x b	h x b	For Arm
16 x 9	6¼ x 3½	12-3912-16

cm	in	
h x b	h x b	For Thigh and Knee
21 x 11	8¼ x 4½	12-3913-21



With 3 Traction Hooks

Kirschner

Clear Width	cm	in
12-3914-01	9.5x7	3¾x2¾
12-3914-02	10.5x10.5	4¼x4¼
12-3914-03	12x12	4¾x4¾
12-3914-04	15.5x15.5	6x6
12-3914-05	20x15.5	8x6



Clear Width

	cm	in
12-3915-18	18x10	07x04
12-3915-27	27x16	10½x06¼



With 3 Traction Hooks

Kirschner

- 12-3916-01 Small Pattern
- 12-3916-02 Medium Pattern
- 12-3916-03 Large Pattern



12-3917-34
34cm/13½"



Spare Screw

Tendon Passing Instruments

Malleable



Bunnell
12-3918-18 18cm/7"
12-3918-23 23cm/9"

Tendon Strippers



Bunnell
23cm/9"

mm Ø
4.0 12-3919-40
4.5 12-3919-45
5.5 12-3919-55
Flexible Shaft



Fischer
12-3920-31
31 cm/12¼"



Brand



12-3921-50
50 cm/19½"
06 mm Ø



12-3922-30
30 cm/12"
03 mm Ø



Brand
12-3923-50
50 cm/19½"

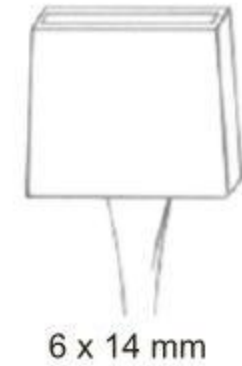

6 x 14 mm

Bone Wire Guides



Bone Wire Tighteners

Loute
 12-3924-00
 21 cm/8 1/4"



Demel

Bone Wire Guides
 Fig. 1 12-3925-01
 Fig. 2 12-3925-02
 Fig. 3 12-3925-03

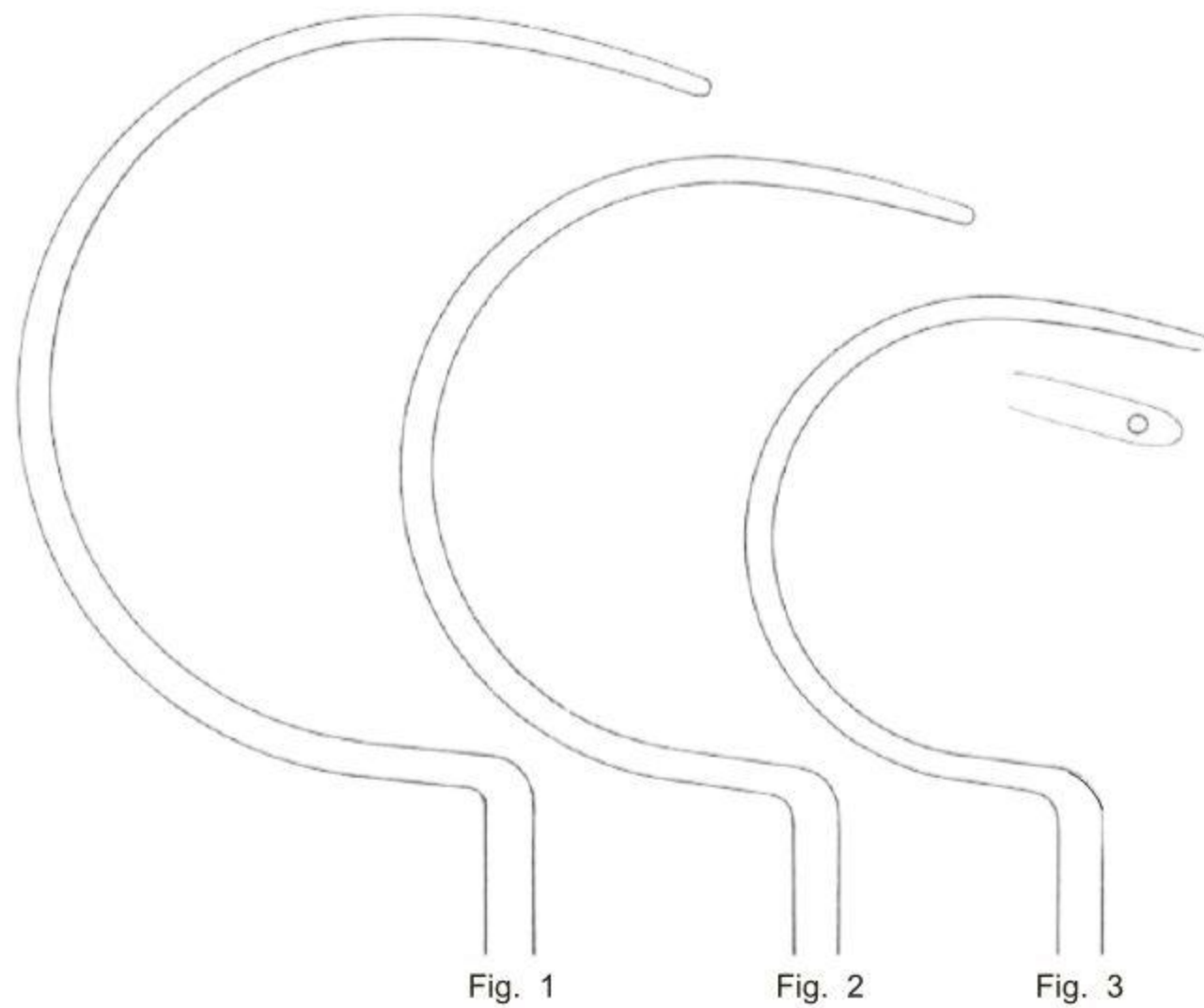

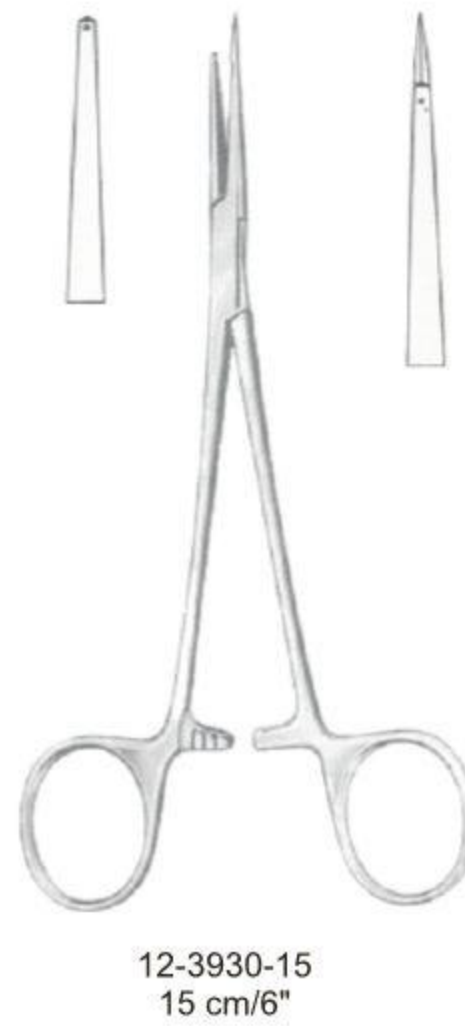
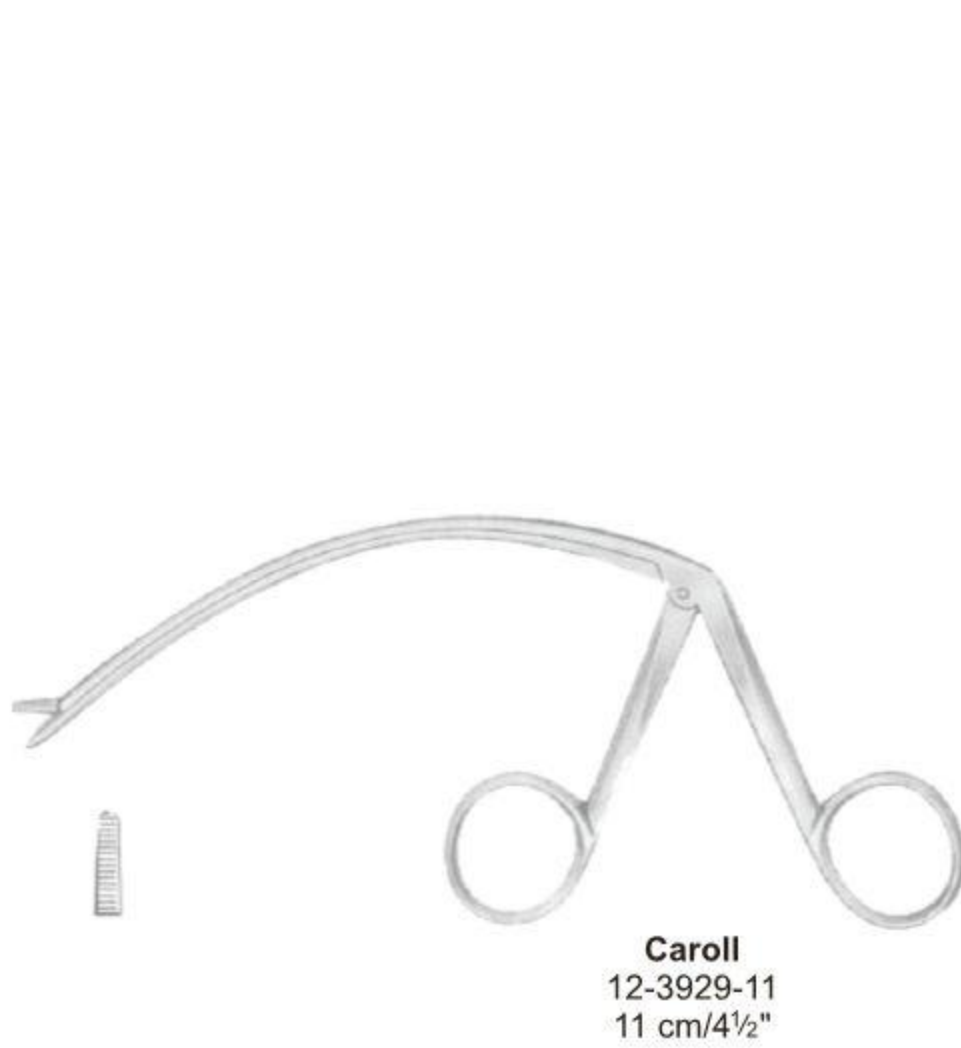
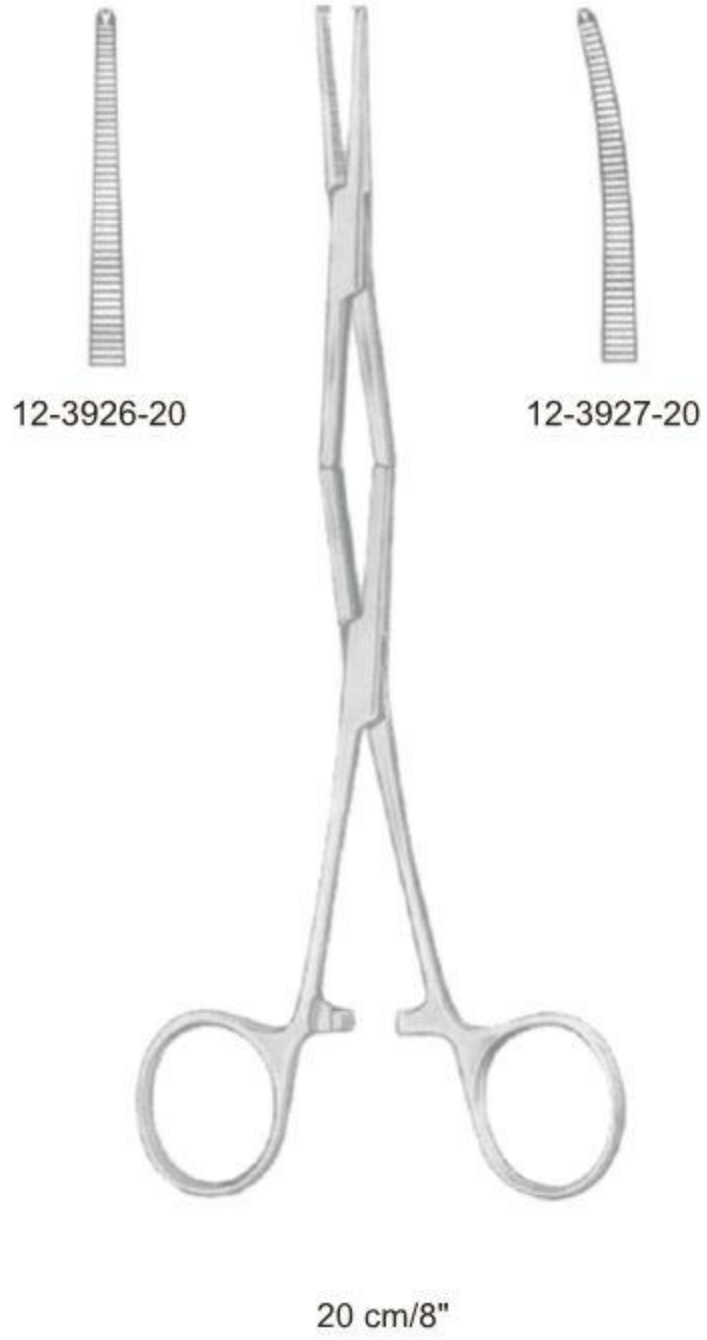

Tendon Seizing Instruments ● EN
 Sehnenfaßinstrumente ● DE
 Instrumentos para coger tendones ● ES



Steinmann
 12-3932-16
 16 cm/6¼"



Larsen
 10 cm/4"



12-3933-02
 2 mm



12-3933-03
 3 mm



12-3933-04
 4 mm



12-3933-05
 5 mm



Kleinert-Kutz
 12-3934-20
 20 cm/8"



Brand
 12-3935-15 15 cm/6"
 12-3935-19 19 cm/7½"
 12-3935-24 24 cm/9½"

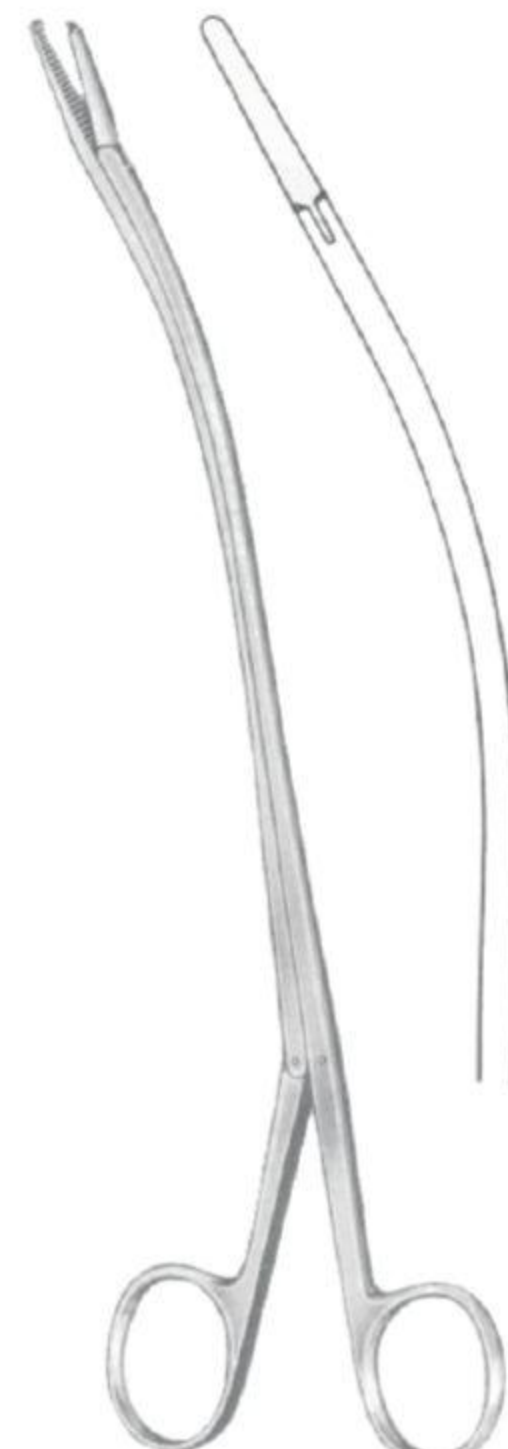

Brand
 12-3936-15 15 cm/6"
 12-3936-19 19 cm/7½"
 12-3936-24 24 cm/9½"

- EN** Plaster Instruments
- DE** Plaster Instrumente
- ES** Instrumentos de yeso

Page 315 to 317





13-4001-20 20.0cm



Seutin
13-4002-23 23.0cm



Brun's
13-4003-24 24.0cm



Brun's (serrated)
13-4004-24 24.0cm



Stille-Mini
13-4005-20 20.0cm



Stille
13-4006-20 20.0cm
13-4006-23 23.0cm
13-4006-26 26.0cm
13-4006-30 30.0cm
13-4006-37 37.0cm



Stille
13-4007-24 24.0cm



Haglund-Stille
13-4008-28 28.0cm



USA Mod Spreader
13-4009-23 23.0cm



Wolff-Boehler
13-4010-18 18.0cm
13-4010-20 20.0cm
13-4010-22 22.0cm
13-4010-24 24.0cm
13-4010-26 26.0cm



Hennig
13-4011-28
28.0cm



Beeson
13-4012-30
30.0cm



Bergmann
13-4013-18 18.0cm



Engel
13-4014-14 14.0cm



Hopkins
13-4015-20 20.0cm



Esmarch
13-4016-18 18.0cm



Reiner
13-4017-18 18.0cm



13-4018-21 21.0cm



Wigmore
13-4019-19 19.0cm

- EN** Cardiovascular Surgery
- DE** Herz- und Gefäßchirurgie
- ES** Cirugía cardiovascular

Page 318 to 357

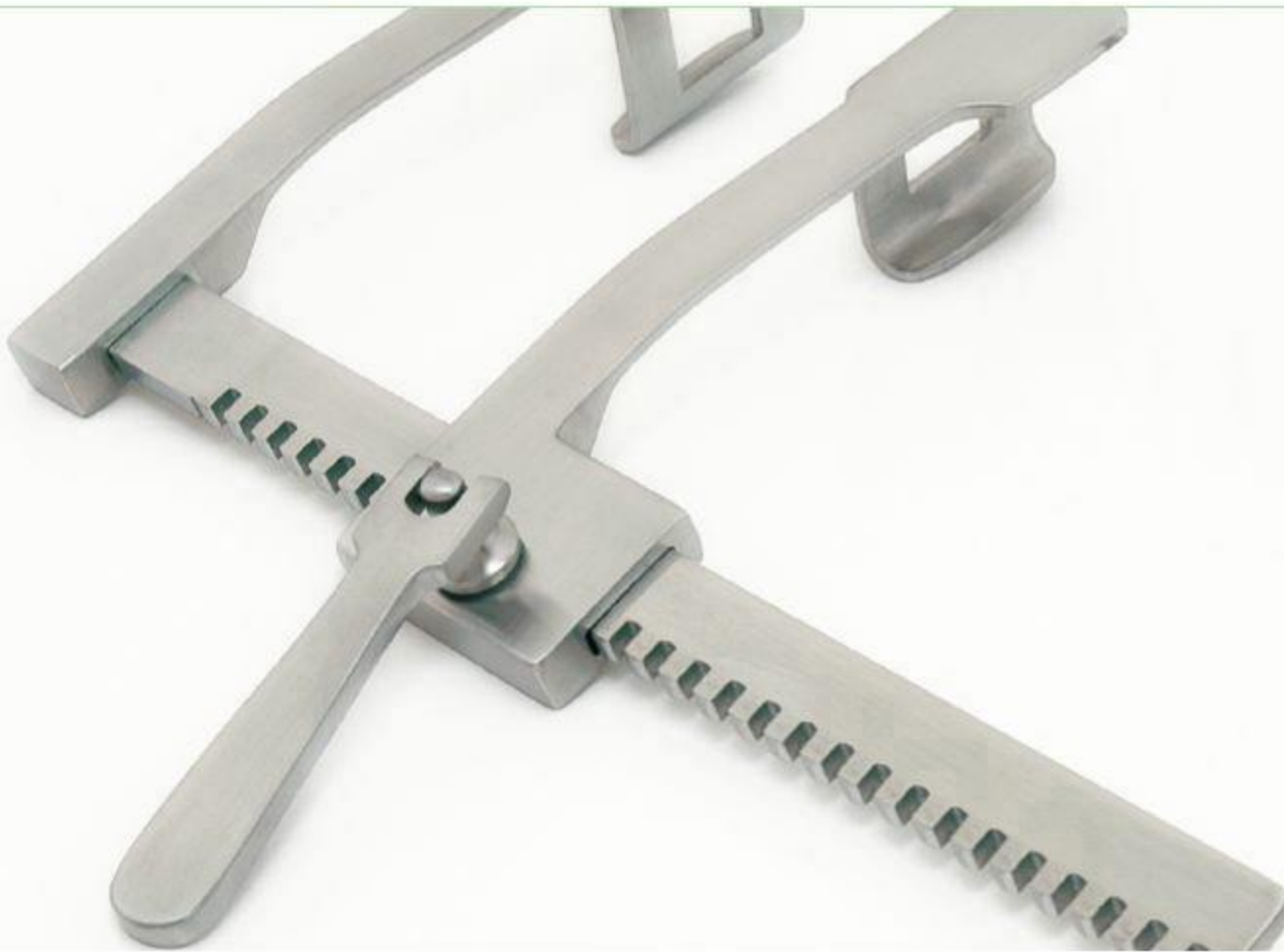

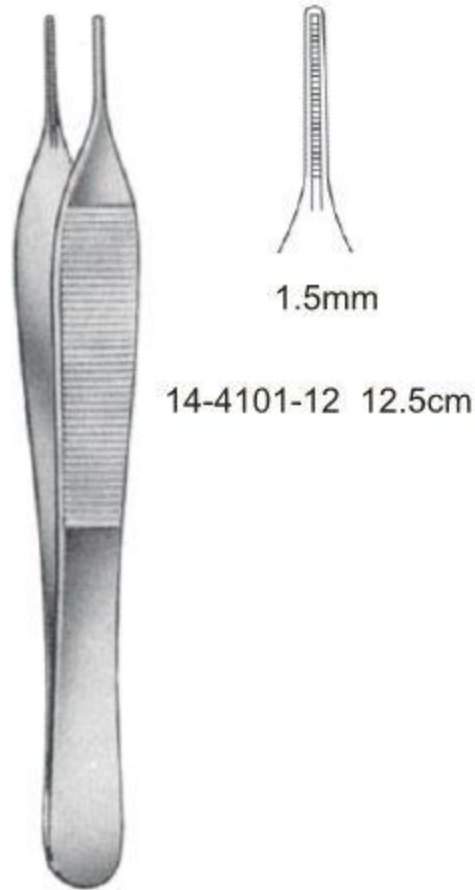

1.5mm
14-4101-12 12.5cm

DEBAKEY-ADSON



1.0mm
14-4102-15 15.0cm
14-4102-18 18.0cm

DEBAKEY-GERALD



1.0mm



1.2mm

14-4103-15 15.0cm
14-4103-18 18.0cm
14-4103-24 24.0cm



1.0mm

14-4104-18 18.0cm

DEBAKEY-CUSHING



1.0mm

14-4105-15 15.0cm 14-4106-15
14-4105-19 19.0cm 14-4106-19
14-4105-24 24.0cm 14-4106-24

DEBAKEY-DIETRICH



1.5mm



1.0mm

14-4107-15 15.0cm
14-4107-19 19.0cm
14-4107-24 24.0cm

DEBAKEY-LIGHT

Atrauma Tissue Forceps ●— EN
 Atrauma Pinzetten ●— DE
 Pinzas de disección Atrauma ●— ES

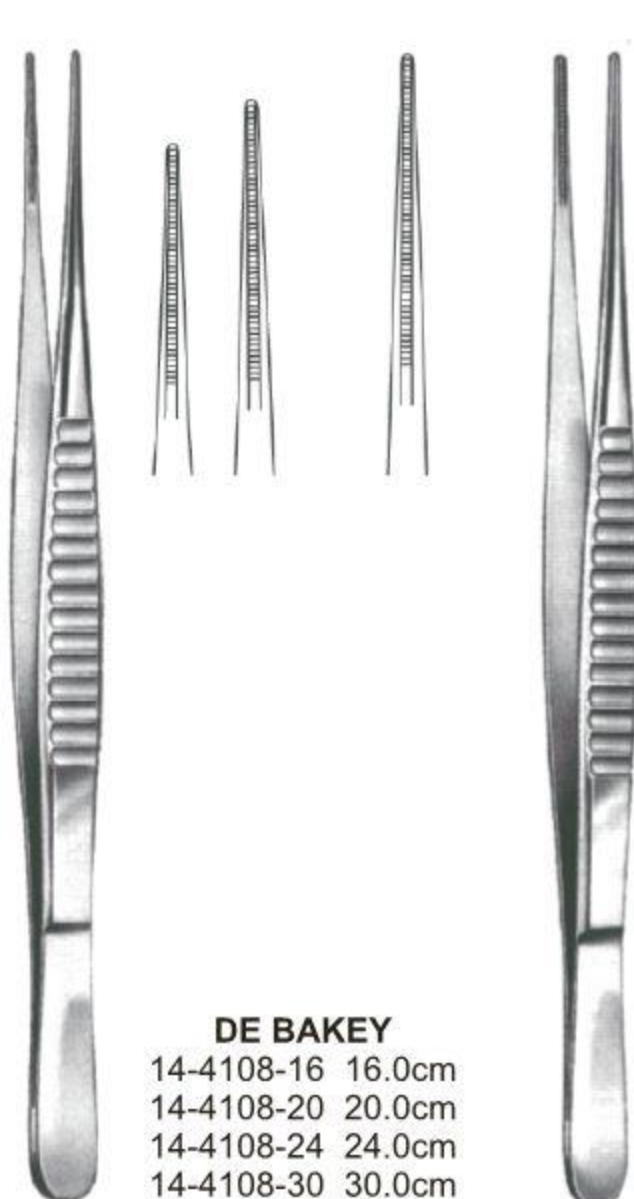

DE BAKEY
 14-4108-16 16.0cm
 14-4108-20 20.0cm
 14-4108-24 24.0cm
 14-4108-30 30.0cm



DE BAKEY
 14-4109-16 16.0cm
 14-4109-20 20.0cm
 14-4109-24 24.0cm
 14-4109-30 30.0cm

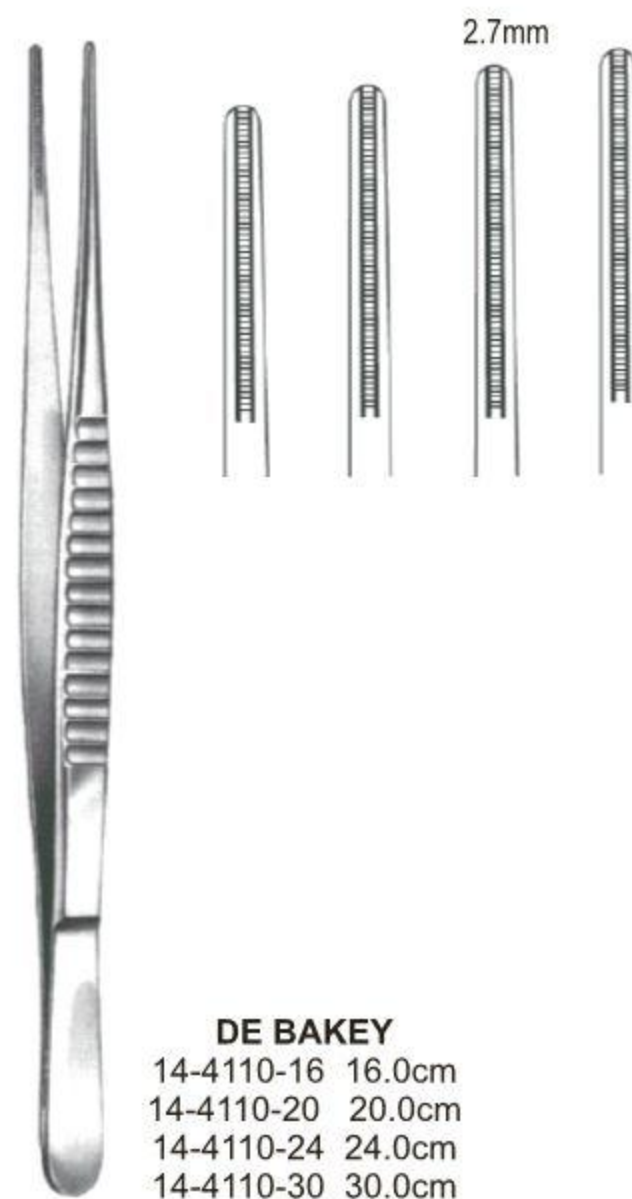

DE BAKEY
 14-4110-16 16.0cm
 14-4110-20 20.0cm
 14-4110-24 24.0cm
 14-4110-30 30.0cm

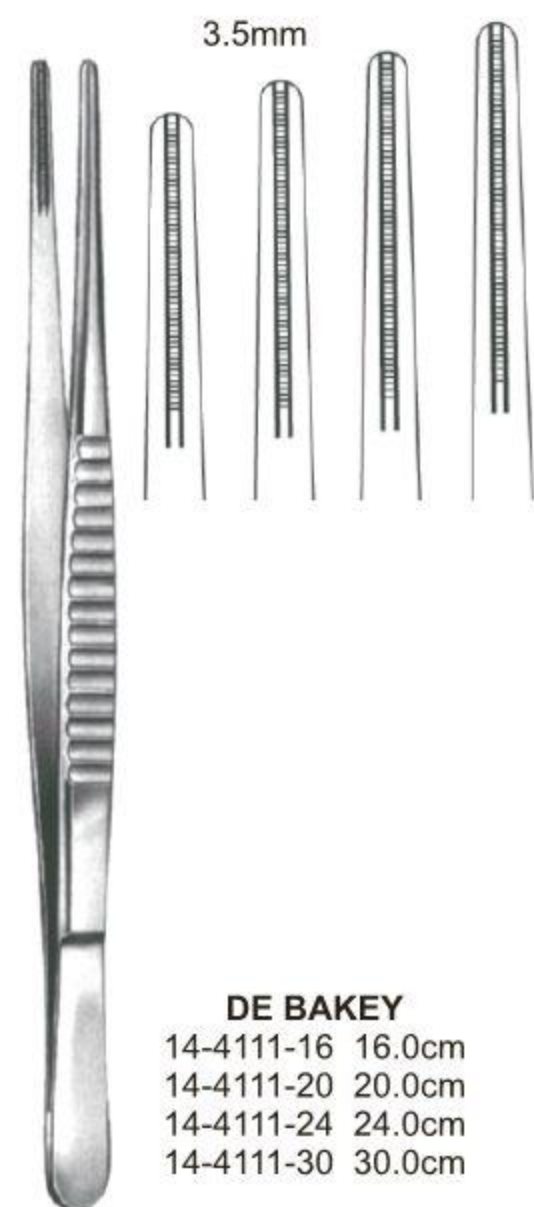

DE BAKEY
 14-4111-16 16.0cm
 14-4111-20 20.0cm
 14-4111-24 24.0cm
 14-4111-30 30.0cm

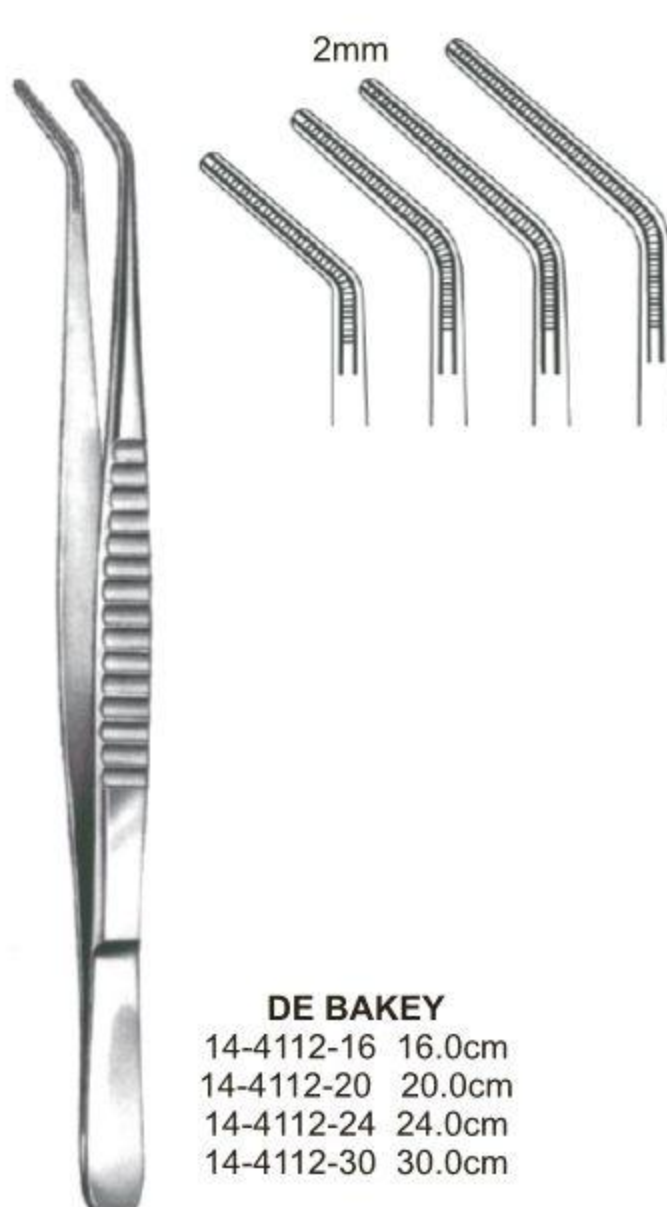

DE BAKEY
 14-4112-16 16.0cm
 14-4112-20 20.0cm
 14-4112-24 24.0cm
 14-4112-30 30.0cm



DE BAKEY
 14-4114-16 16.0cm
 14-4114-20 20.0cm
 14-4114-24 24.0cm
 14-4114-30 30.0cm

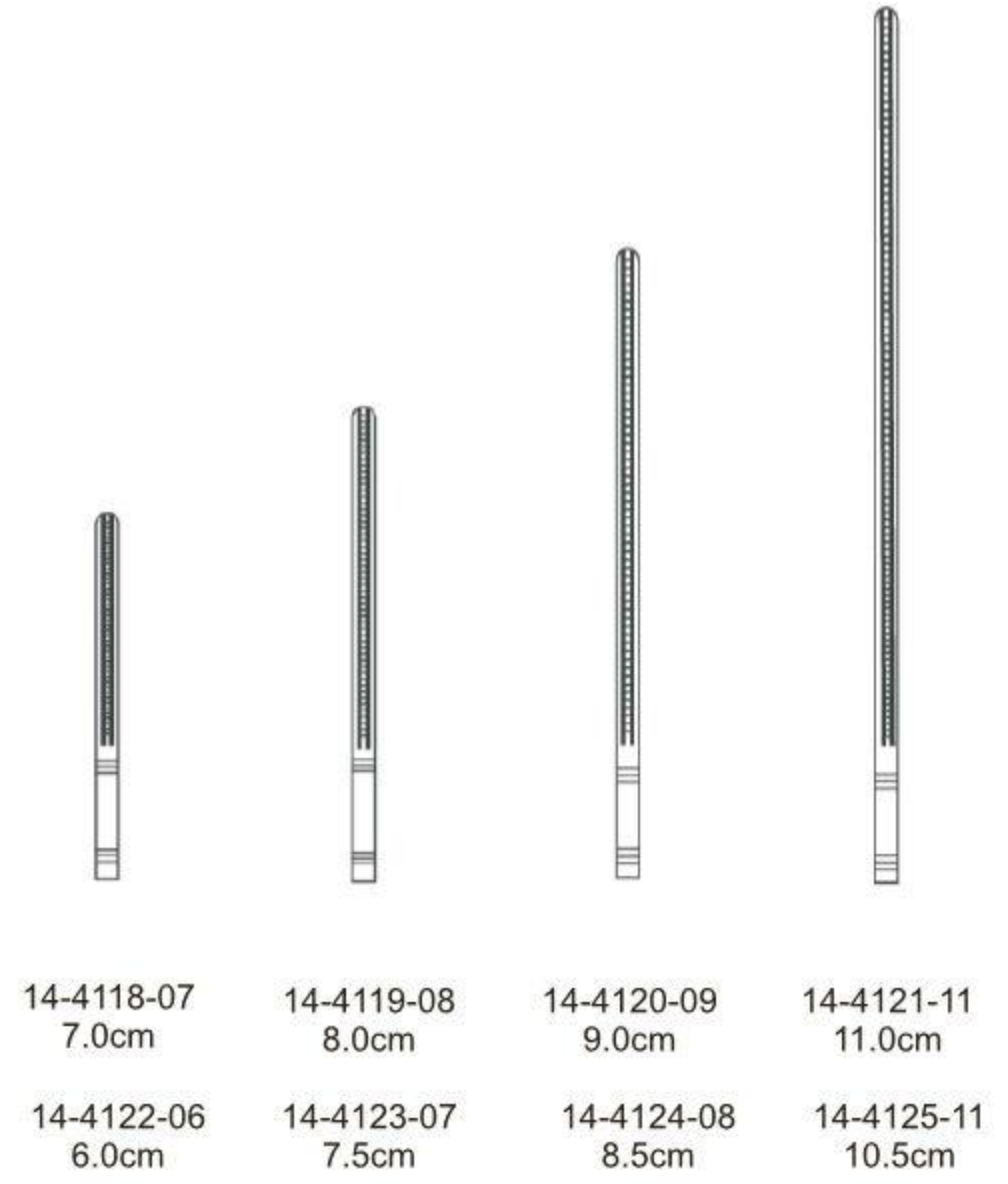
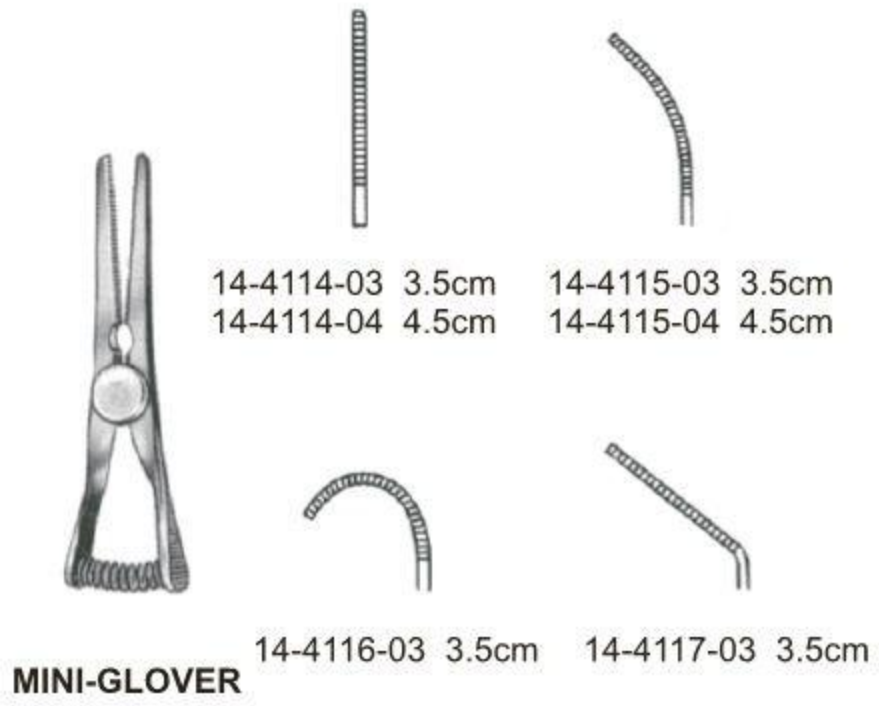

14-4126-05 5.0cm

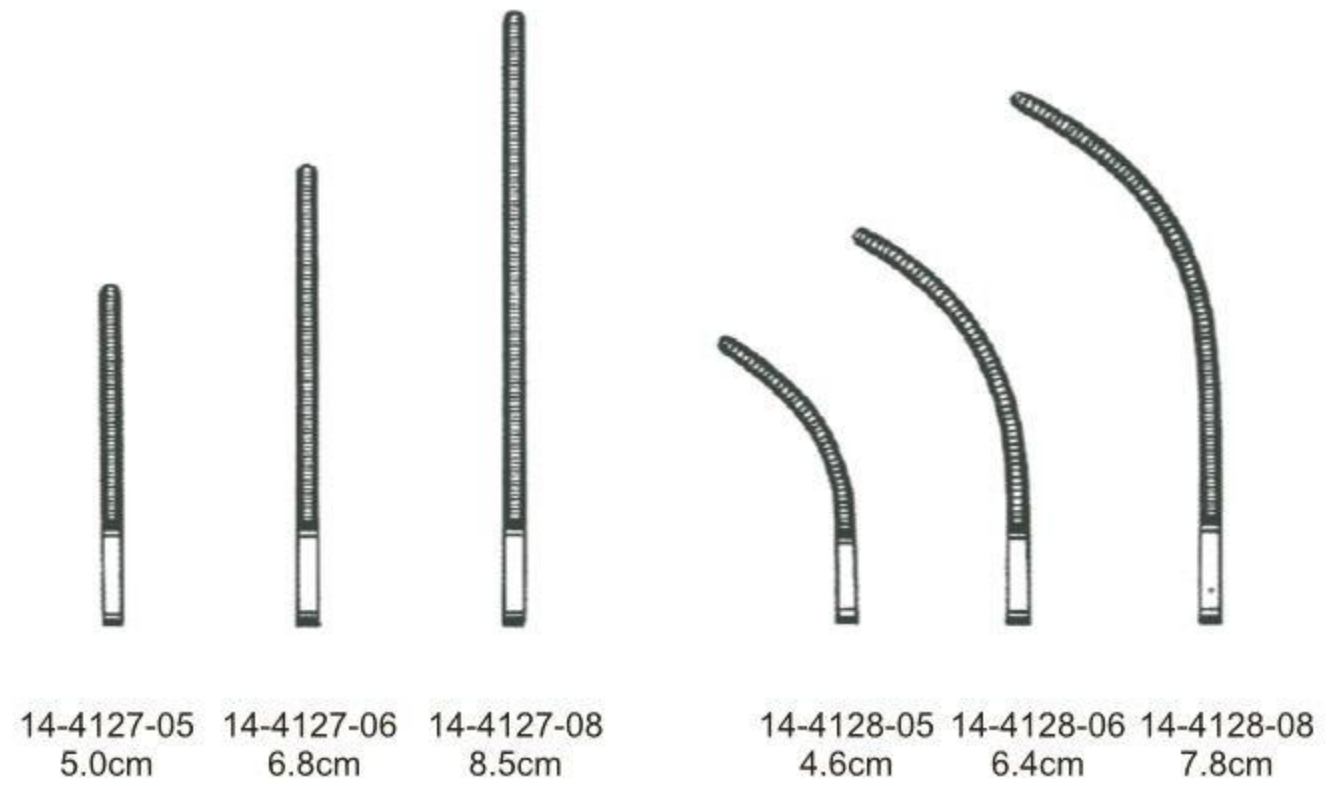

Atrauma Bulldog Clamps ●— EN
 Atrauma Bulldogklemmen ●— DE
 Atrauma Clamps Bulldog ●— ES



DE BAKEY

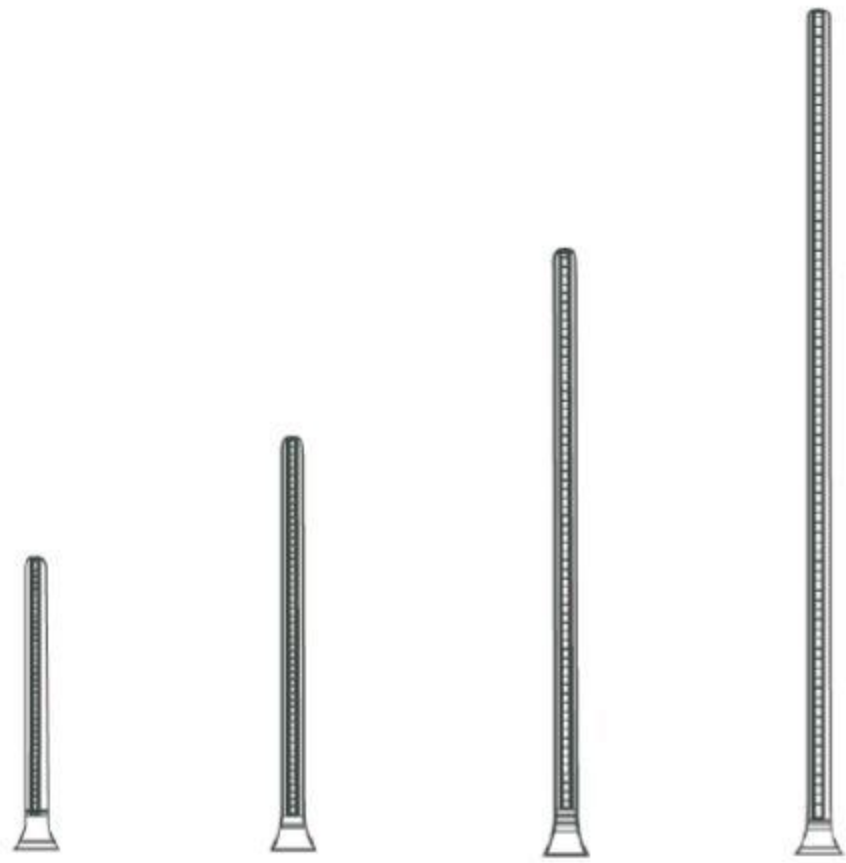

14-4129-07
7.5cm

14-4129-08
8.5cm

14-4129-10
10.5cm

14-4129-12
12.0cm



DE BAKEY

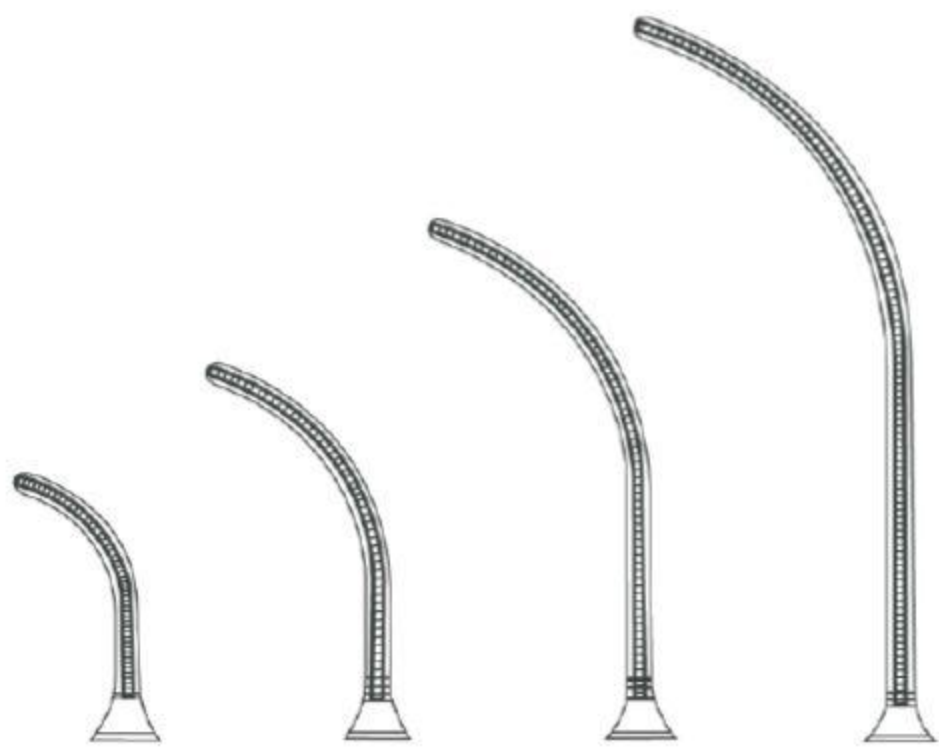

14-4130-07
7.0cm

14-4130-08
8.0cm

14-4130-10
10.0cm

14-4130-11
11.5cm



14-4131-23 23.0cm

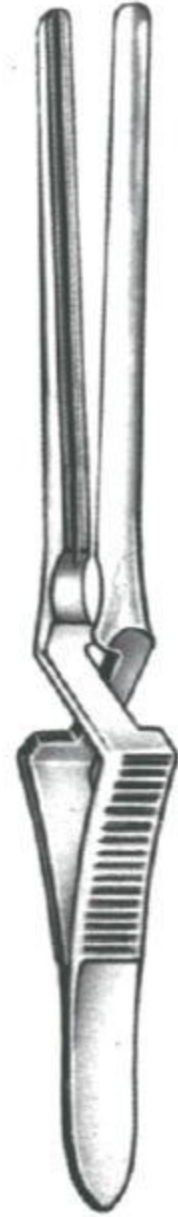

GREGORY SOFT

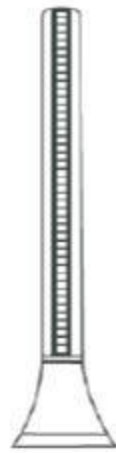

14-4132-09
9.0cm

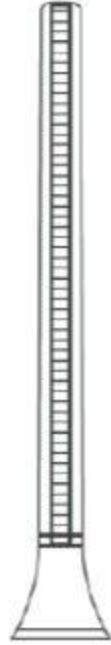

14-4132-11
11.0cm



GREGORY SOFT



14-4133-09
9.0cm

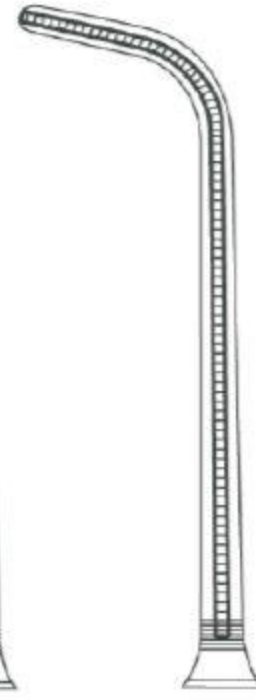

14-4133-11
11.0cm



GREGORY SOFT
11.0cm



14-4134-01



14-4134-02



SANTULLI
14-4135-07 7.0cm

Atrauma Bulldog Clamps ● EN

Atrauma Bulldogklemmen ● DE

Atrauma Clamps Bulldog ● ES



DE BAKEY-SATINSKY
14-4136-07 7.0cm



DE BAKEY-SATINSKY
14-4137-10 10.0cm



DE BAKEY-CAROTIS
14-4138-09 9.0cm



De Bakey

Coarctation Clamps



14-4139-21
21 cm/8¼"

14-4139-22
22 cm/8¾"



14-4140-21
21 cm/8¼"

14-4140-22
22 cm/8¾"

Potts
(De Bakey)

Potts
(De Bakey)



De Bakey

Anastomosis Clamps



Potts



14-4141-21
21 cm/8¼"



14-4141-22
22 cm/8¾"



Glover
(Potts)



14-4142-21
21 cm/8¼"

14-4142-22
22 cm/8¼"

Dissecting and
 Ligature Forceps



De Bakey



14-4143-20
 20 cm/8"



14-4143-24
 24 cm/9½"



De Bakey



14-4144-20
 20 cm/8"



14-4144-18
 18 cm/7½"



De Bakey



Leland-Jones



14-4145-01
 19.5 cm/7½"



14-4145-02
 19.5 cm/7½"



14-4145-03
 19.5 cm/7½"



Leland-Jones
 14-4146-18
 18 cm/7"

Aortic Aneurysm Clamps



De Bakey



De Bakey



14-4147-24
24 cm/9½"



14-4147-27
27 cm/10½"



14-4147-31
31 cm/12¼"



14-4147-33
33.5 cm/13¼"



De Bakey-Bainbirdge



14-4148-15
15 cm/6"



14-4148-18
18 cm/7"



14-4148-15
15 cm/6"



14-4148-18
18 cm/7"



De Bakey
14-4149-20
20 cm/8"

Atrauma Cardiovascular Forceps ● EN
 Atrauma cardiovascular-klemmen ● DE
 Atrauma pinzas-clamps cardiovasculares ● ES



De Bakey

Aortic Aneurysm Clamps



De Bakey
 14-4150-28
 28 cm/11"



14-4151-30
 30 cm/12"



De Bakey

Aortic Clamps



Ochsner
14-4152-23
23.5 cm/9¼"



Dietrich
14-4153-21
21 cm/8¼"



De Bakey

Auricle Clamp



Harken



14-4154-01
 24 cm/9½"



14-4155-02
 24 cm/9½"



14-4156-03
 24 cm/9½"



14-4157-04
 24 cm/9½"



De Bakey

Bronchus Clamps

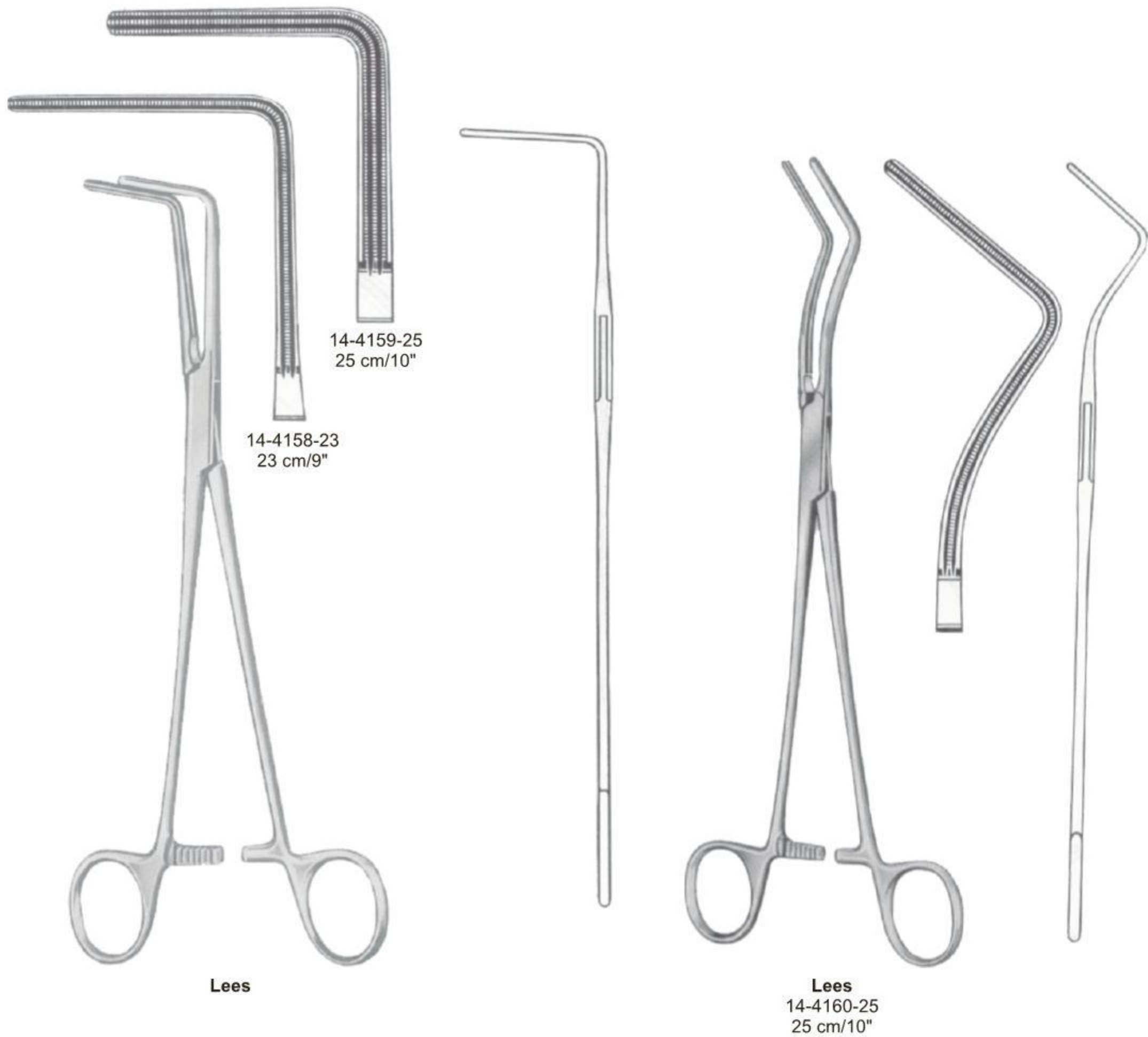



De Bakey

Aortic Clamp

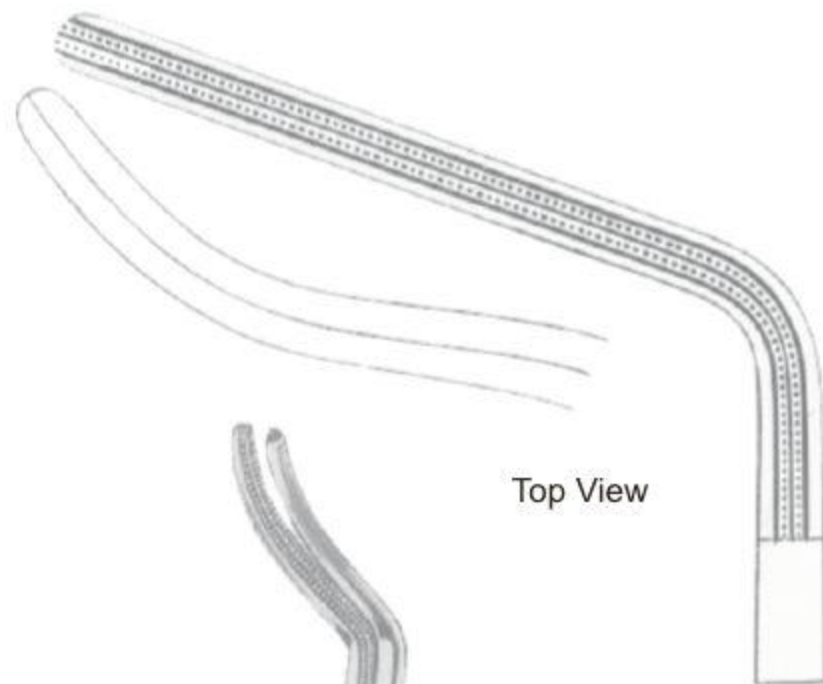

Top View



De Bakey
 14-4161-27
 27 cm/10½"

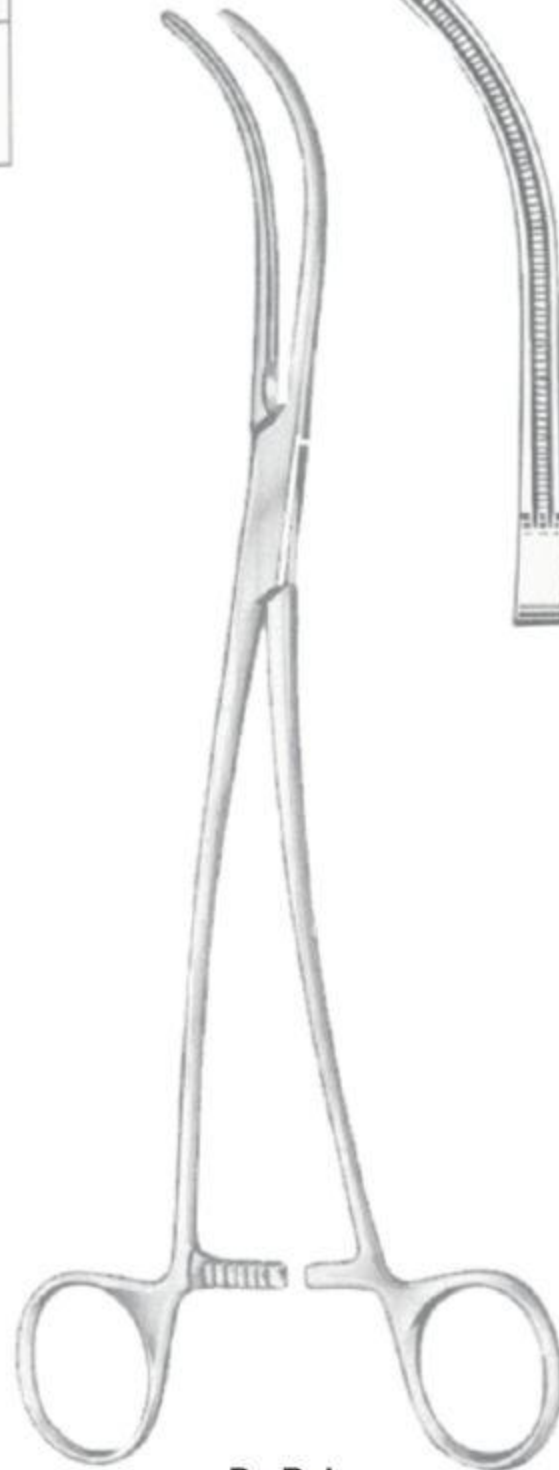

De Bakey
 14-4162-24
 24 cm/9½"

Ligature Clamps



De Bakey
 14-4163-24
 24 cm/9½"

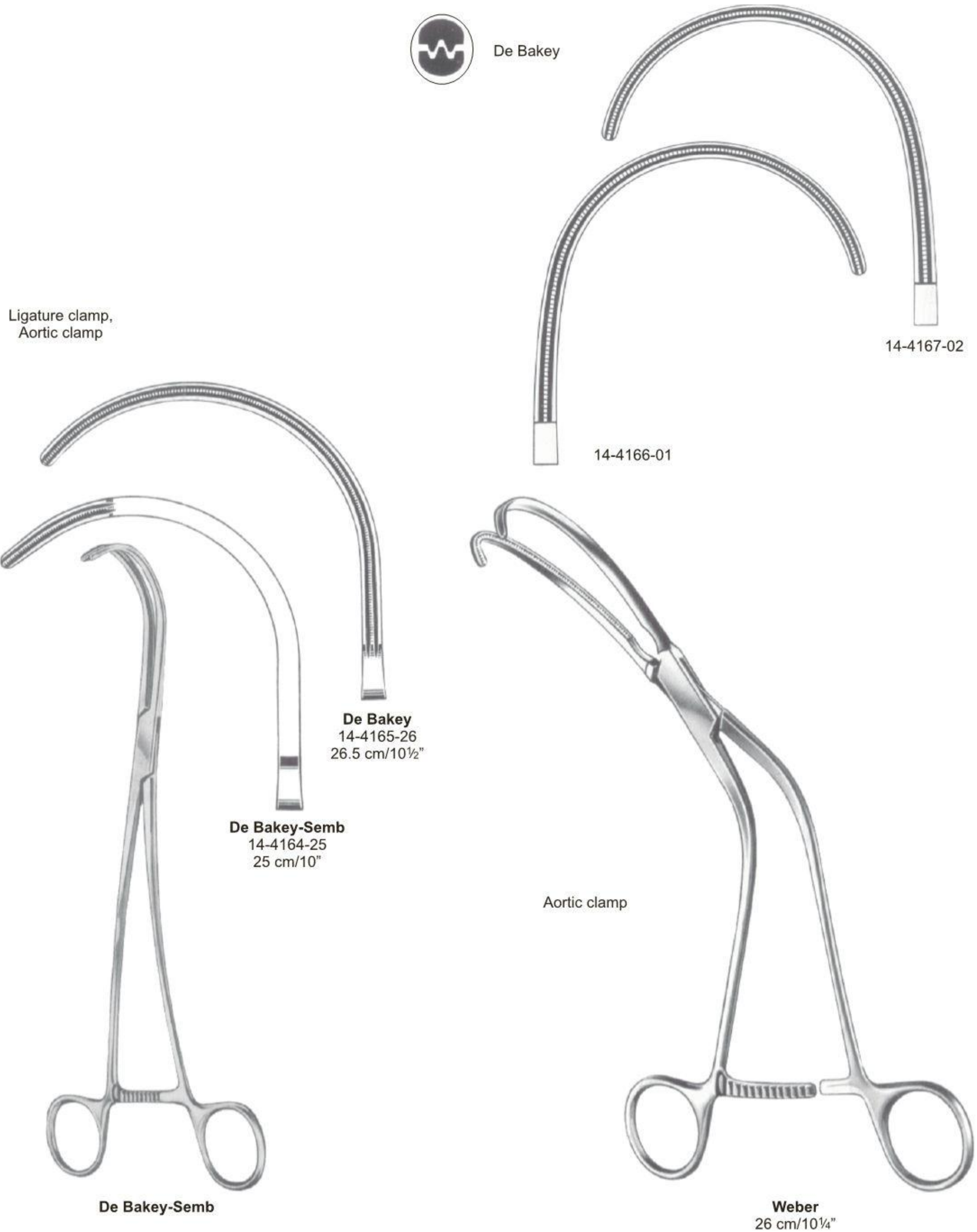



Satinsky/De Bakey

Tangential occlusion clamps



De Bakey

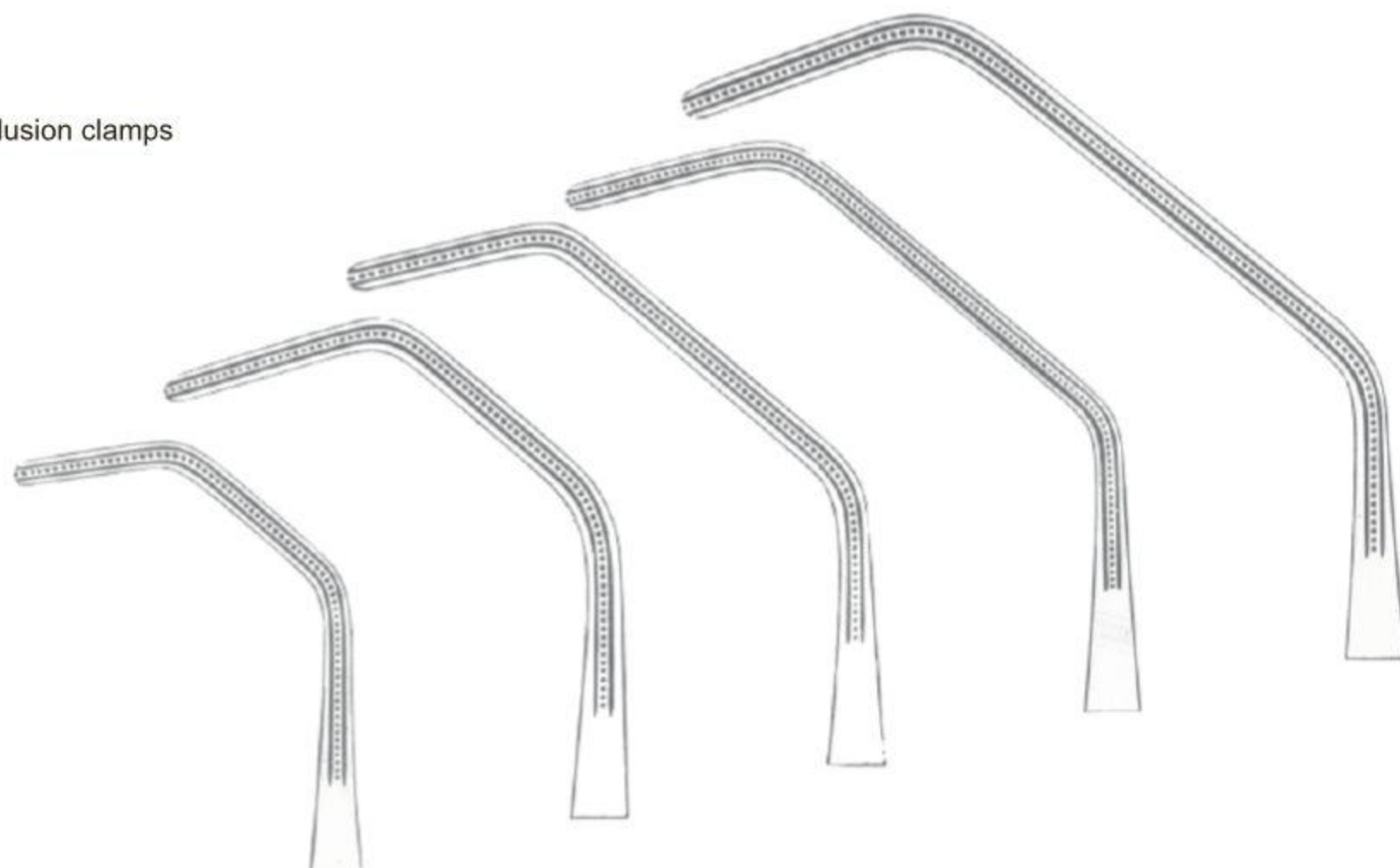

Set of 5 purchase.
 14-4168-00

14-4168-20
 20 cm/8"

14-4168-25
 25 cm/10"

14-4168-26
 26 cm/10¼"

14-4168-27
 27 cm/10½"

14-4168-28
 28 cm/11"



Glover

14-4169-01 19.5 cm/7¾"
 14-4169-02 21.0 cm/8¼"

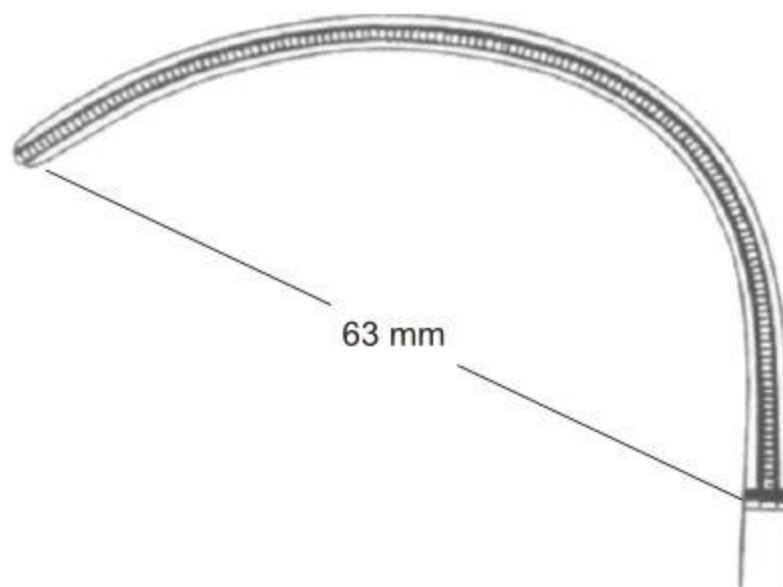

Anastomosis

14-4169-01

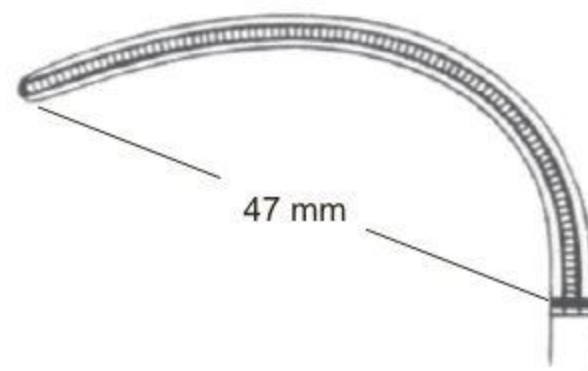

14-4169-02



De Bakey



De Bakey
14-4170-16
16 cm/6 1/4"

Graduated

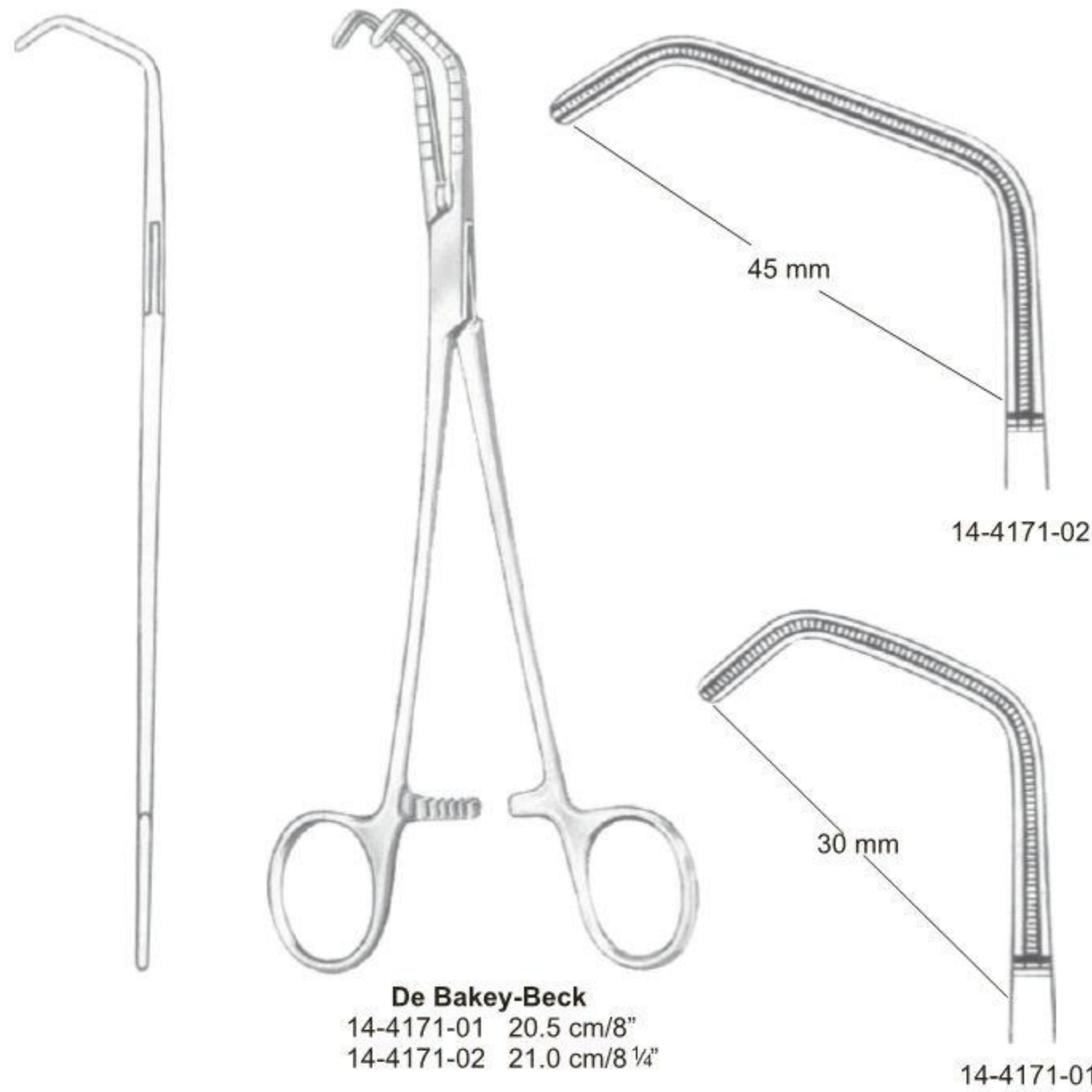

De Bakey-Beck
14-4171-01 20.5 cm/8"
14-4171-02 21.0 cm/8 1/4"



De Bakey



Lambert-Kay
 21 cm/8¼"



Aortic anastomosis clamps

14-4172-21



De Bakey
 14-4173-17
 17 cm/6¾"



Beck
 14-4174-17
 17 cm/6¾"



De Bakey



Multi purpose clamps

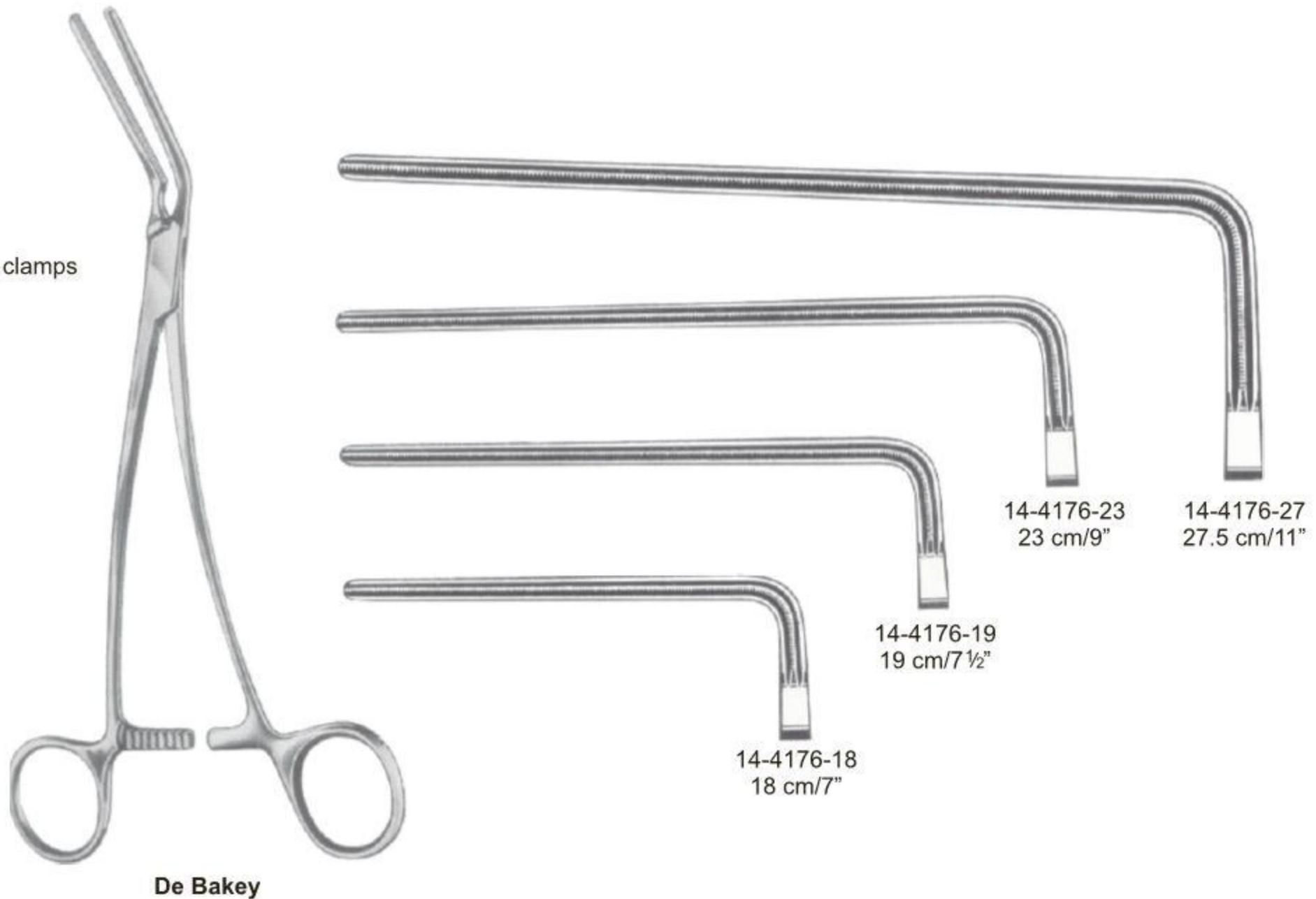

Atrauma Cardiovascular Forceps ● EN
 Atrauma cardiovascular-klemmen ● DE
 Atrauma pinzas-clamps cardiovasculares ● ES



Aortic anastomosis clamps

Morris-De Bakey

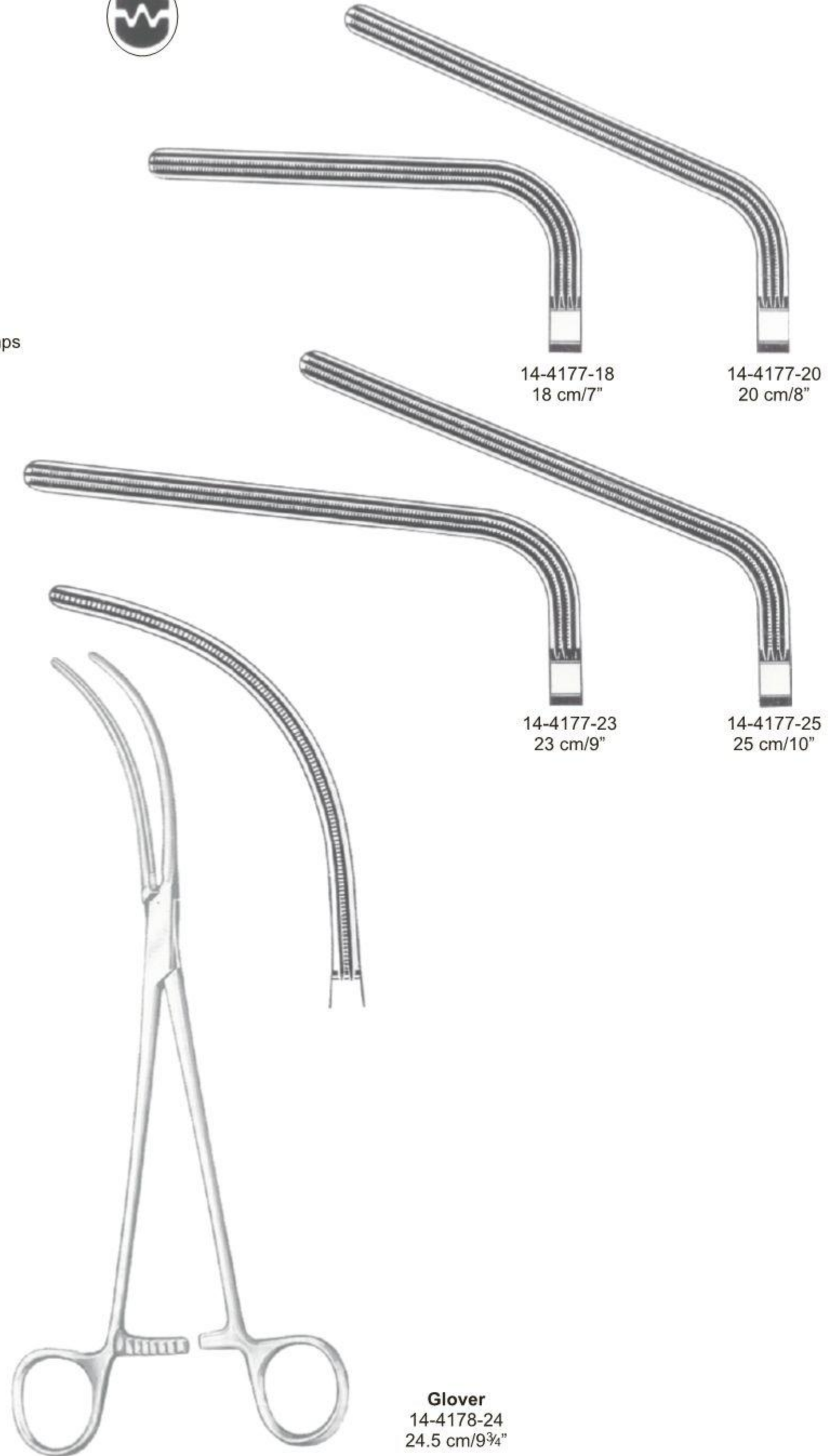

14-4177-18
 18 cm/7"

14-4177-20
 20 cm/8"

14-4177-23
 23 cm/9"

14-4177-25
 25 cm/10"

Glover
 14-4178-24
 24.5 cm/9¾"

Aorta aneurysm clamps



De Bakey-Bahnson



De Bakey



14-4179-24
24.5 cm/9¾"



14-4179-25
25.5 cm/10"



14-4179-26
26.5 cm/10½"

Coarctation clamps



Straight	cm/in	Curved
14-4180-21	21.5 cm/8½"	14-4181-21
14-4180-23	23.0 cm/9"	14-4181-23
14-4180-27	27.0 cm/10½"	14-4181-27
14-4180-31	31.5 cm/12½"	14-4181-31

Multi purpose clamps



De Bakey



De Bakey-Rankin



14-4182-16
16 cm/6¼"



14-4182-16
16 cm/6¼"



Cooley



14-4183-16
16 cm/6¼"

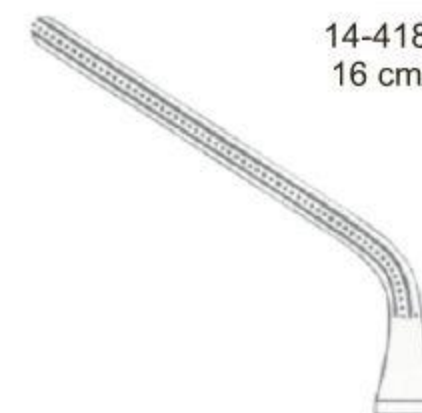

14-4183-15
15.5 cm/6"



14-4183-14
14.5 cm/5¾"



De Bakey
14-4184-17
17 cm/6¾"

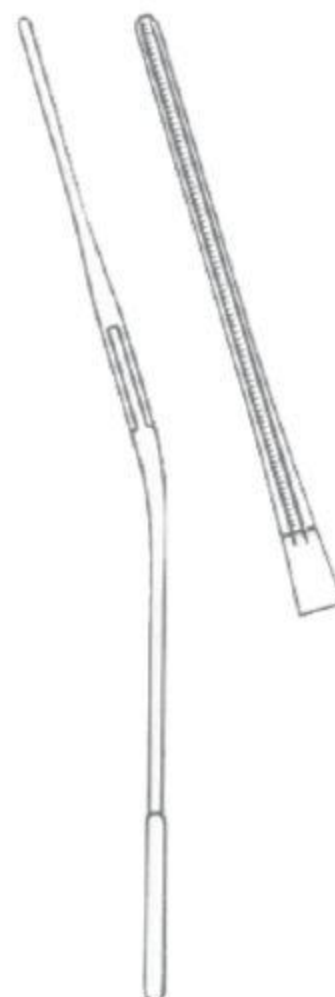

14-4185-17



14-4186-17



14-4187-17



De Bakey

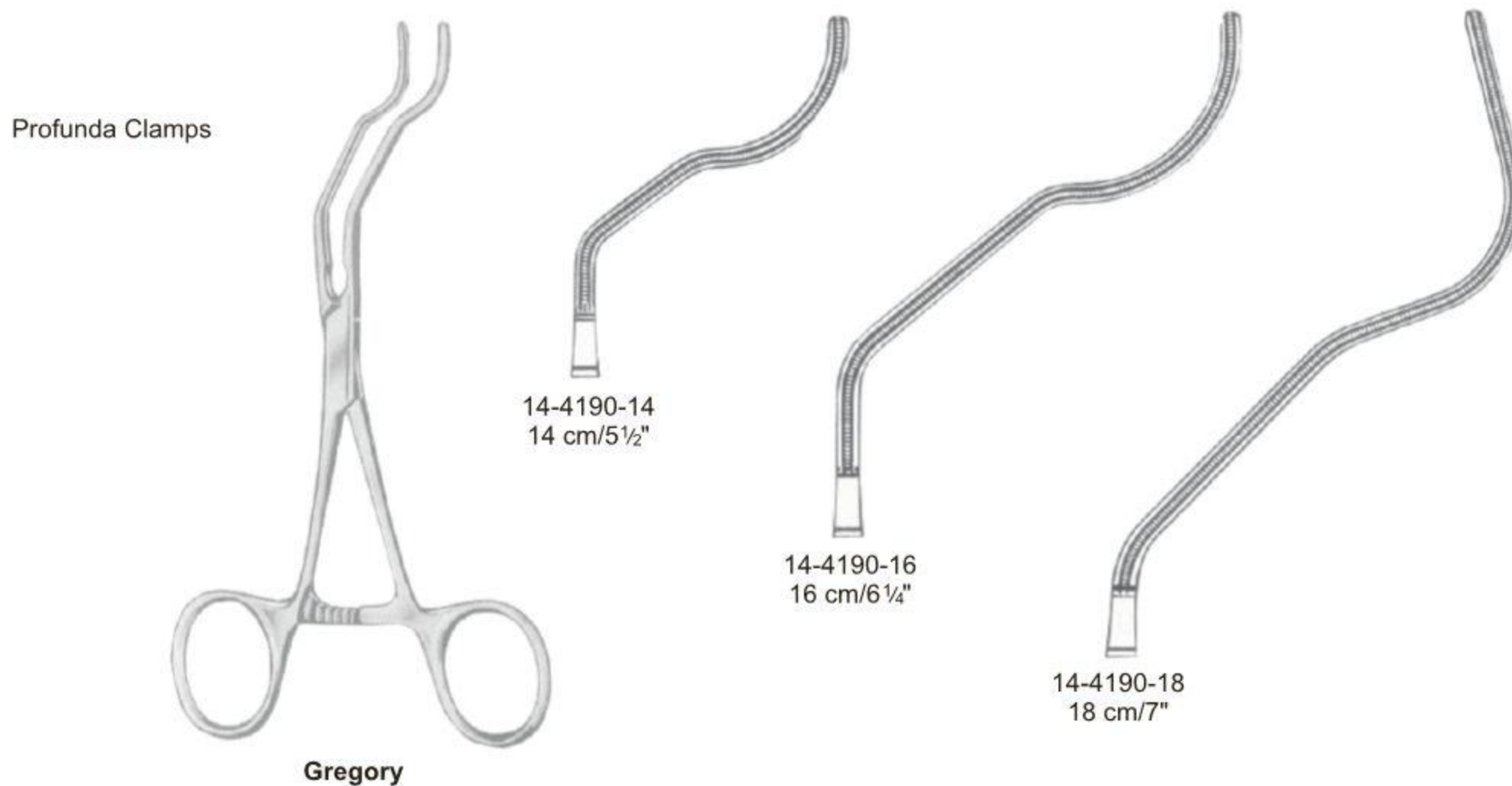
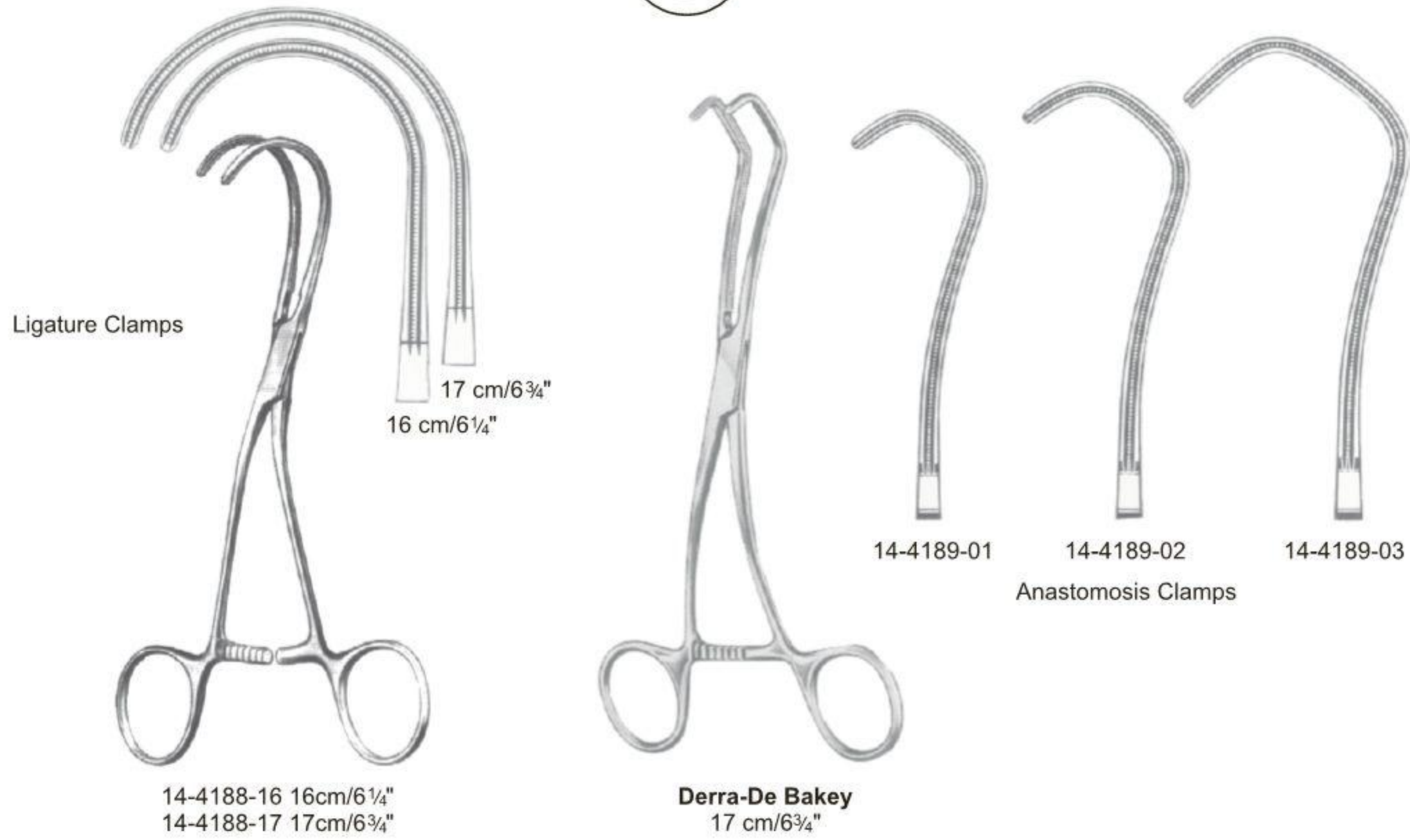



Cooley

Coarctation Clamps



Cooley
 14-4191-17
 17 cm/6¾"



14-4192-17
 17 cm/6¾"



14-4193-17
 17 cm/6¾"

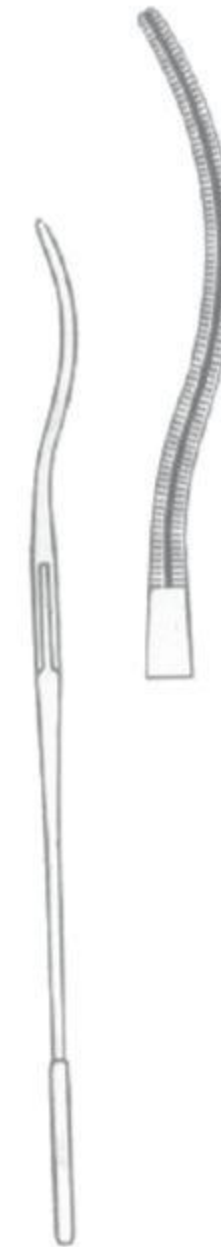

14-4194-17
 17 cm/6¾"



Cooley
14-4195-20
20 cm/8"



Cooley



Cooley



14-4196-03
17 cm/6¾"

14-4197-02
15.5 cm/6"



14-4198-01
15 cm/6"



Cooley
14-4199-17
17 cm/6¾"

Anastomosis clamps



Cooley



Cooley



14-4200-01
 16.5 cm/6½"



14-4200-02
 16.5 cm/6½"

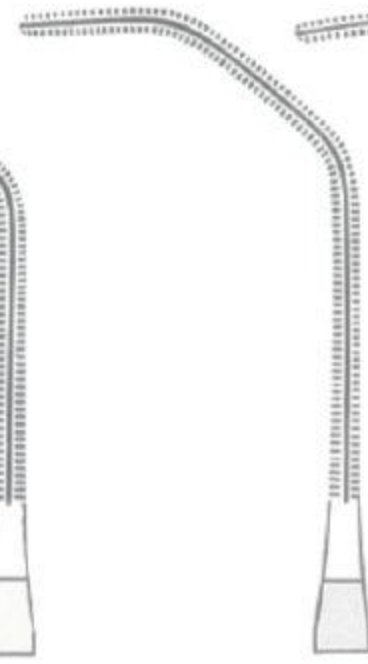

14-4200-03
 17.5 cm/7"

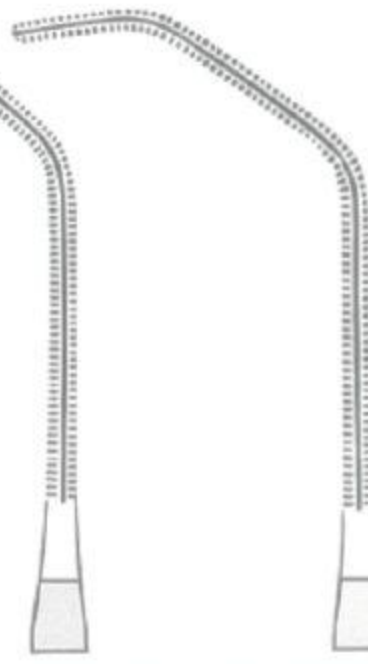

29-0980714-4200
 17.5 cm/7"

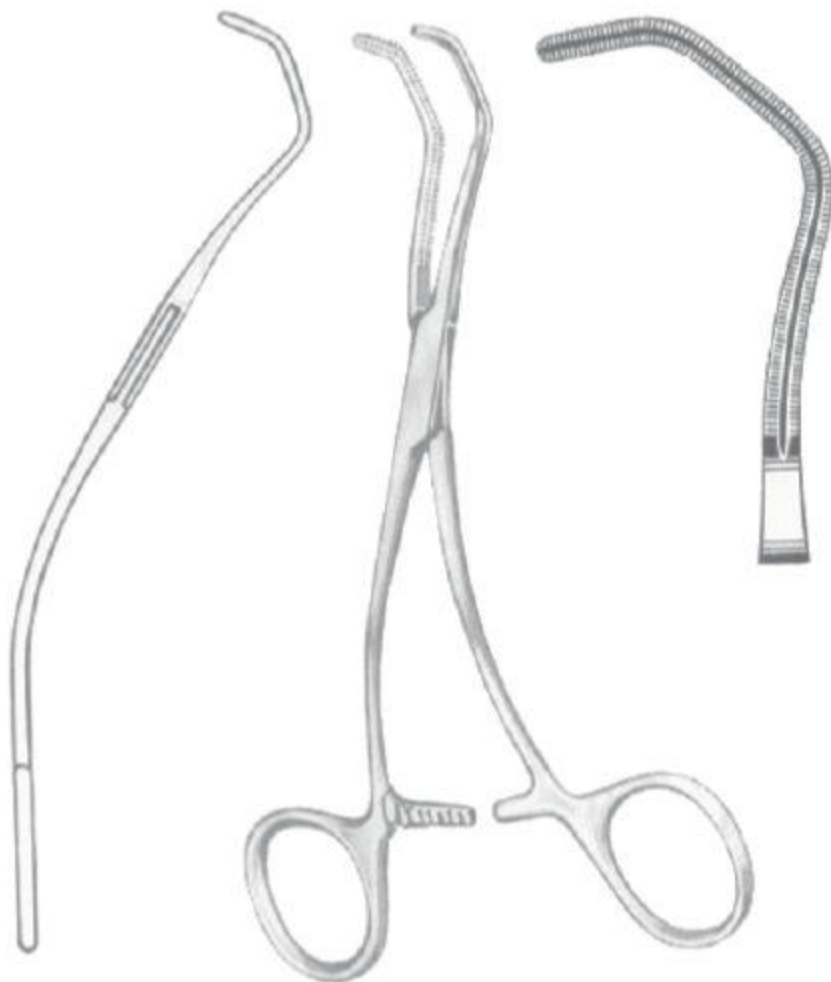

Cooley
 14-4201-16
 16 cm/6¼"

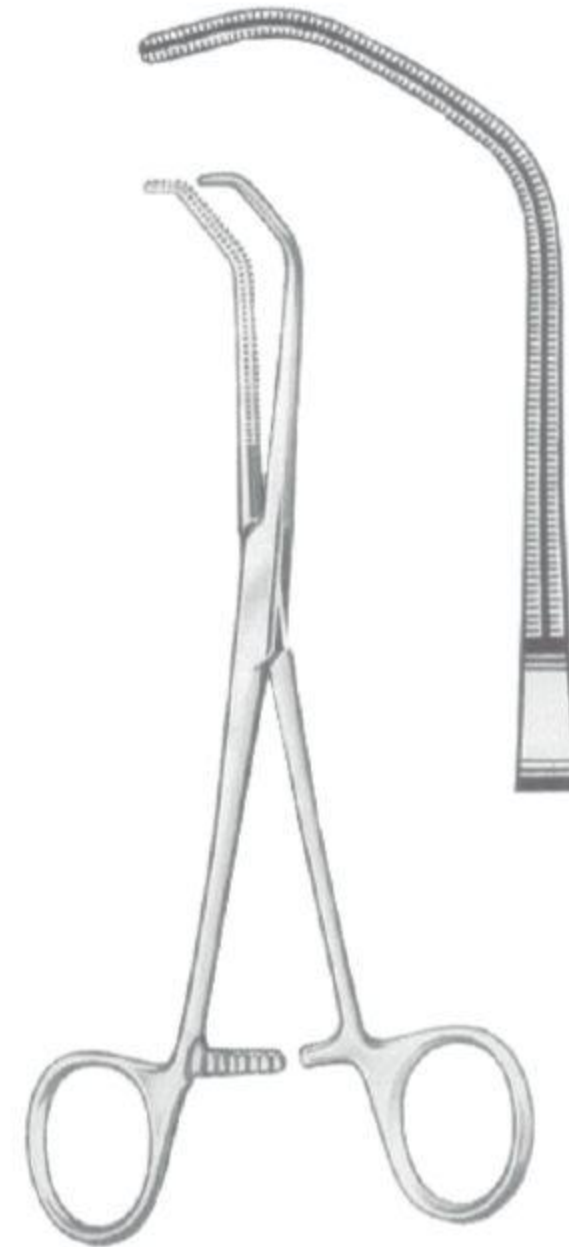

Beck
 14-4202-17
 17 cm/6¾"



Cooley



Cooley-Derra



14-4203-16
16 cm/6 1/4"



14-4203-17
17 cm/6 3/4"



14-4203-18
18 cm/7"



Cooley
14-4204-16 16 cm/6 1/4"
14-4204-17 17 cm/6 3/4"



16 cm/6 1/4"

17 cm/6 3/4"

Ligature clamps



Cooley



Cooley
 14 cm/5½"



Cooley
 14-4207-14
 14 cm/5½"



Cooley
 14-4208-14
 14 cm/5½"



Cooley
 14-4209-14
 14 cm/5½"



Cooley
14-4210-01
25 cm/10"



Cooley
14-4211-02
33 cm/13"



Cooley
14-4212-03
30 cm/12"



Cooley
14-4213-04
30 cm/12"



Cooley
14-4214-05
35 cm/13³/₄"

Tourniquets



Rumel-Belmont
14-4215-32 3.2 mm Ø
14-4215-64 6.4 mm Ø

Dilators ●— EN
Dilatatoren ●— DE
Dilatadores ●— ES

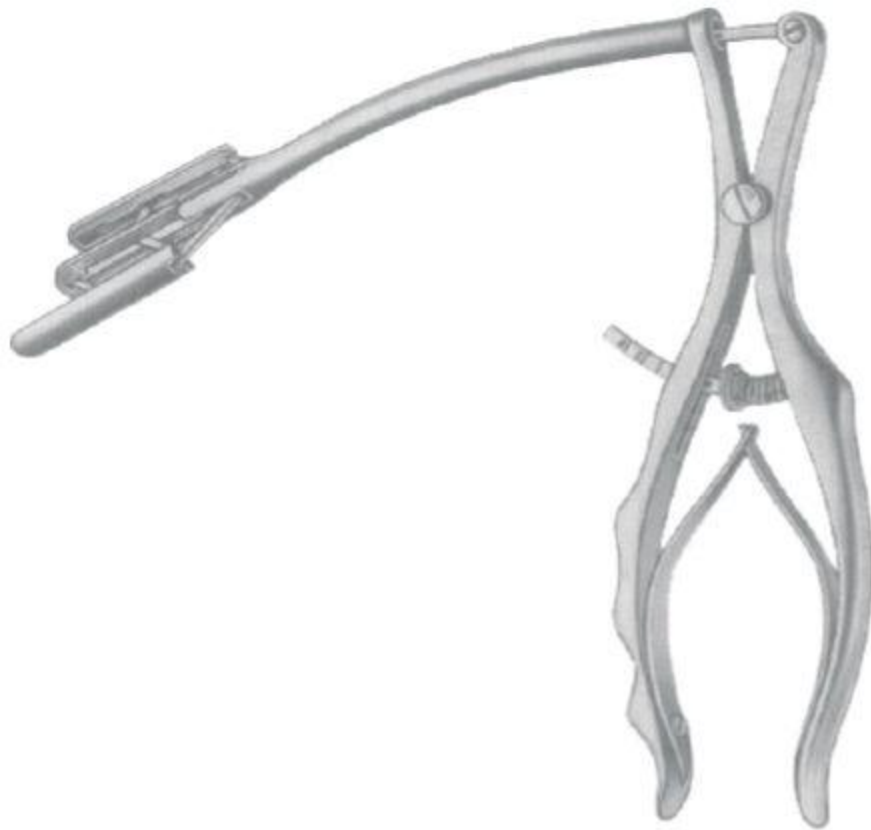

Cooley
14-4216-00



Gerbode
14-4217-00



Tubbs
14-4218-00



De Bakey

mm Ø	19 cm/7 1/2"	35 cm/14"
0.5	14-4219-05	14-4220-05
1.0	14-4219-10	14-4220-10
1.5	14-4219-15	14-4220-15
2.0	14-4219-20	14-4220-20
2.5	14-4219-25	14-4220-25
3.0	14-4219-30	14-4220-30
3.5	14-4219-35	14-4220-35
4.0	14-4219-40	14-4220-40
4.5	14-4219-45	14-4220-45
5.0	14-4219-50	14-4220-50
7.0	14-4219-70	14-4220-70
9.0	14-4219-90	14-4220-90

Malleable

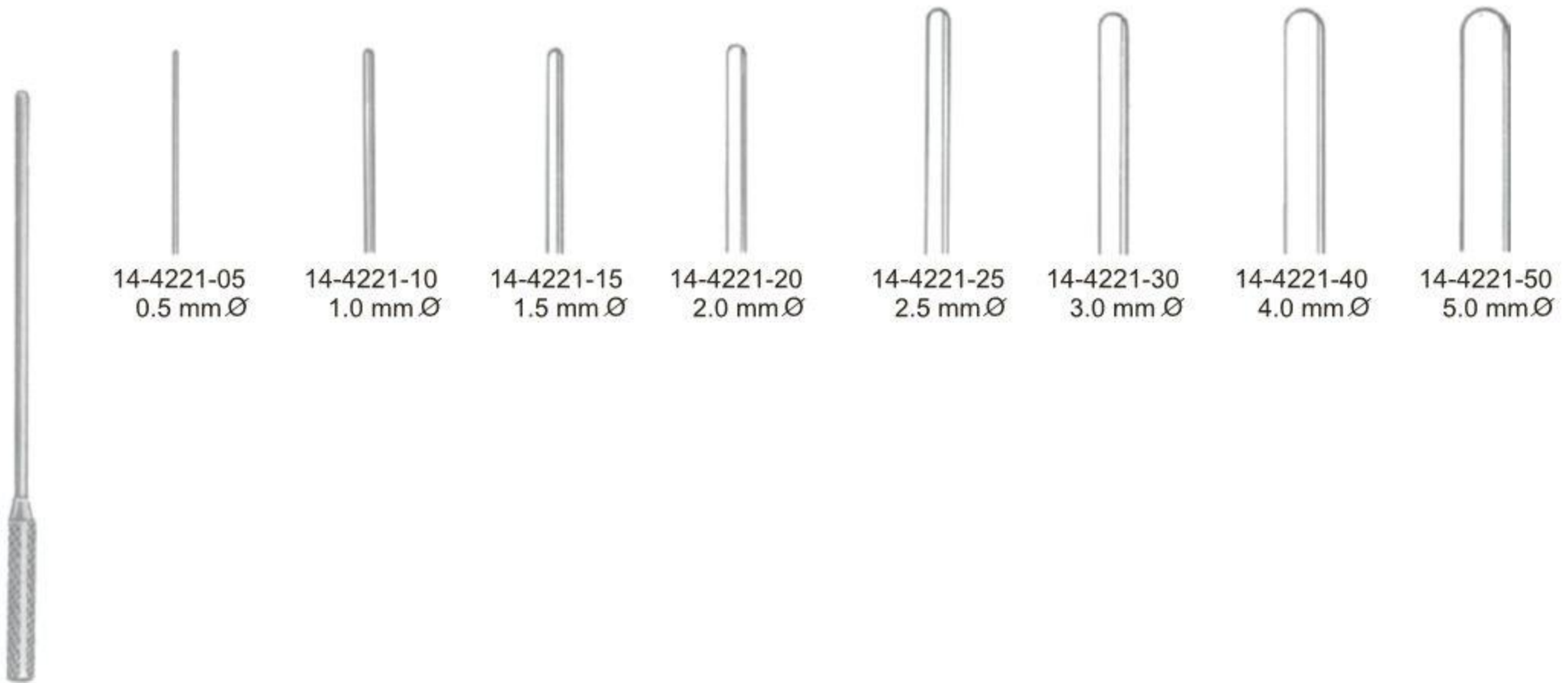

14-4221-05
0.5 mm Ø

14-4221-10
1.0 mm Ø

14-4221-15
1.5 mm Ø

14-4221-20
2.0 mm Ø

14-4221-25
2.5 mm Ø

14-4221-30
3.0 mm Ø

14-4221-40
4.0 mm Ø

14-4221-50
5.0 mm Ø

Cooley
13 cm/5"

Rib Shears, Sternum Scissors and Sternum Chisels ● EN

Rippenscheren, Sternumschere, Sternummeißel ● DE

Costótomos, Tijera de esternón, cincel de esternón ● ES



Sauerbruch
14-4222-24 24 cm/9½"
14-4222-26 26 cm/10¼"



Giertz-Stillle
14-4223-27
27 cm/10½"

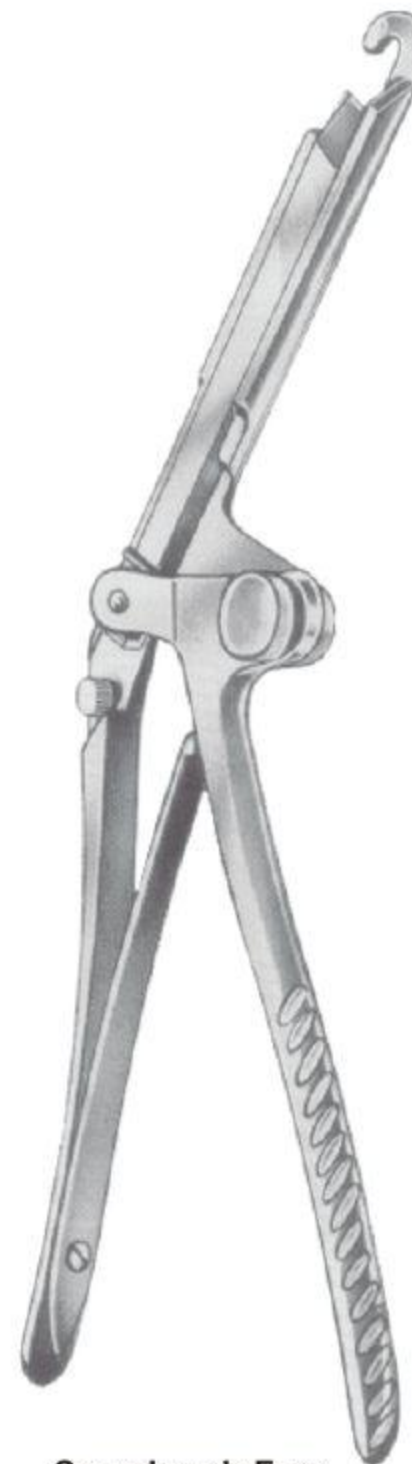

Sauerbruch-Frey
14-4224-36
36 cm/14"



Bethune
14-4225-34
34 cm/13½"

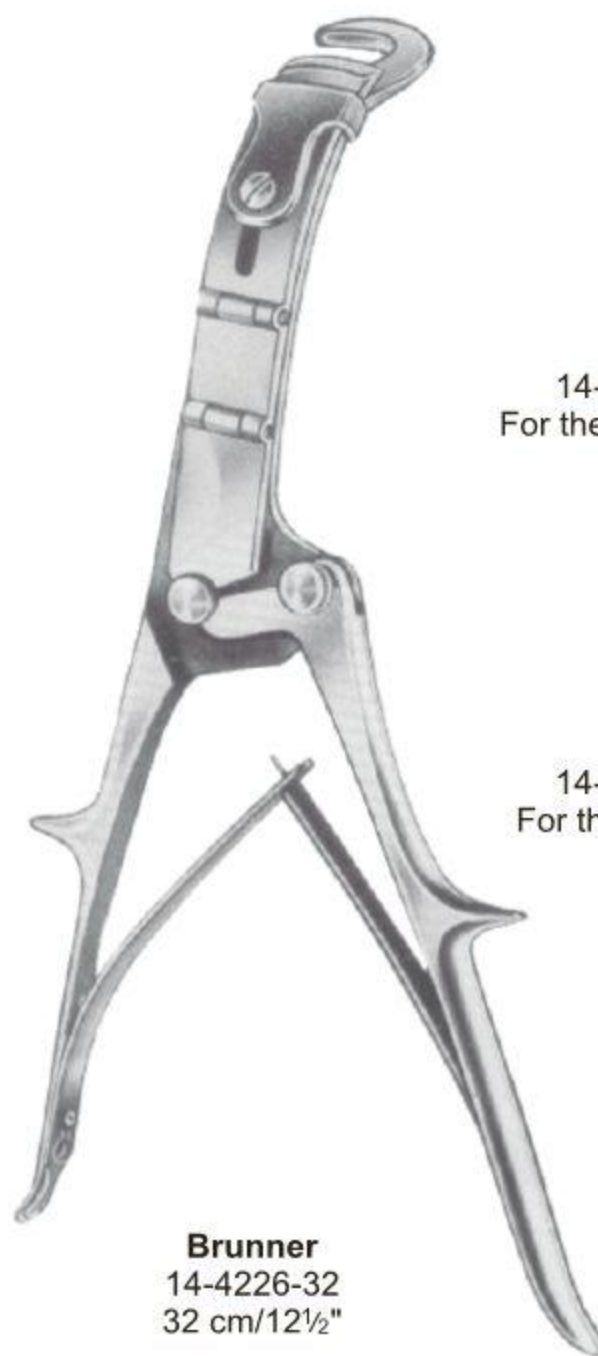

Brunner
14-4226-32
32 cm/12½"

14-4226-32
For the Right Hand

14-4227-32
For the left Hand



Lebsche
14-4228-24
24.5 cm/9¾"



Finocchietto-Baby

	a	b	c
14-4229-00	18 mm	21 mm	105 mm

Scheme of Dimensions

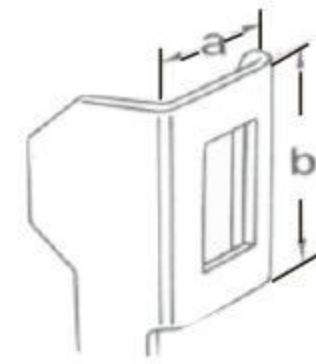

Size of Blades

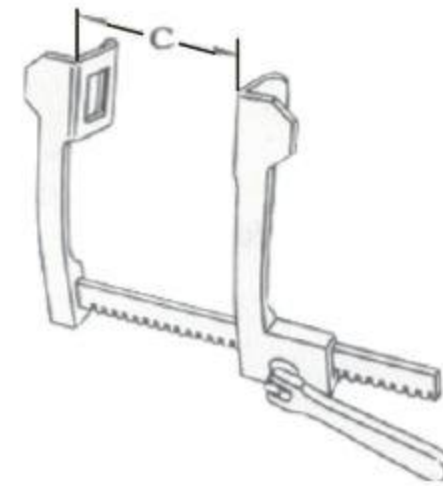

Total Spread



Finocchietto

	a	b	c
14-4230-01	36 mm	45 mm	165 mm
14-4230-02	44 mm	65 mm	200 mm
14-4230-03	44 mm	65 mm	250 mm
14-4230-04	44 mm	65 mm	300 mm
14-4230-05	65 mm	65 mm	200 mm
14-4230-06	65 mm	65 mm	250 mm
14-4230-07	65 mm	65 mm	300 mm

Rib Spreaders ●— EN
 Rippensperrer ●— DE
 Separadores costales ●— ES

With 2 Pairs of Interchangeable Blades



Finocchietto-Burford

Blade Opening
 14-4231-01 200 mm/8"
 14-4231-02 250 mm/10"
 14-4231-03 305 mm/12"

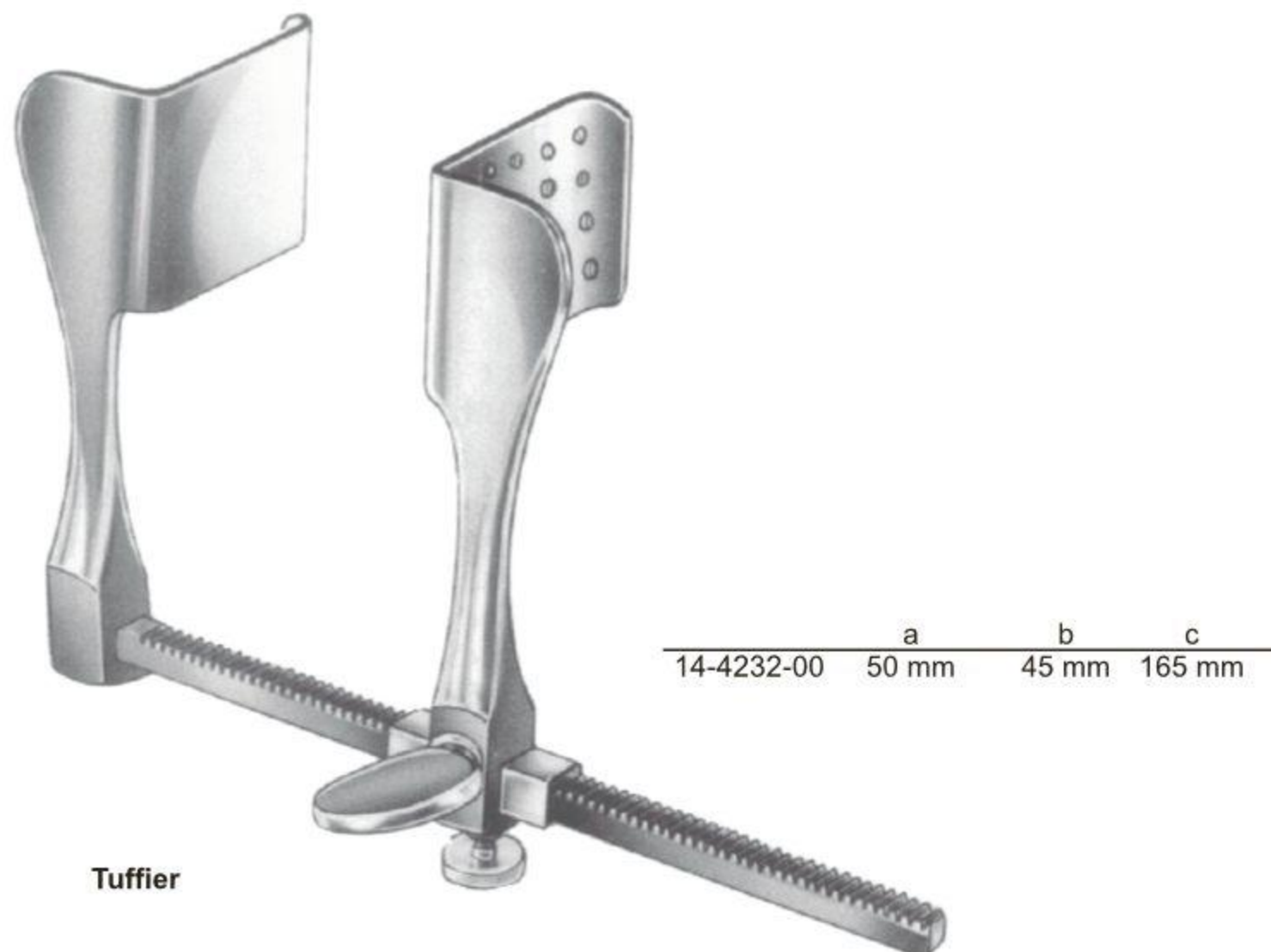

Tuffier



Haight

	a	b	c
14-4233-00	30 mm	30 mm	115 mm

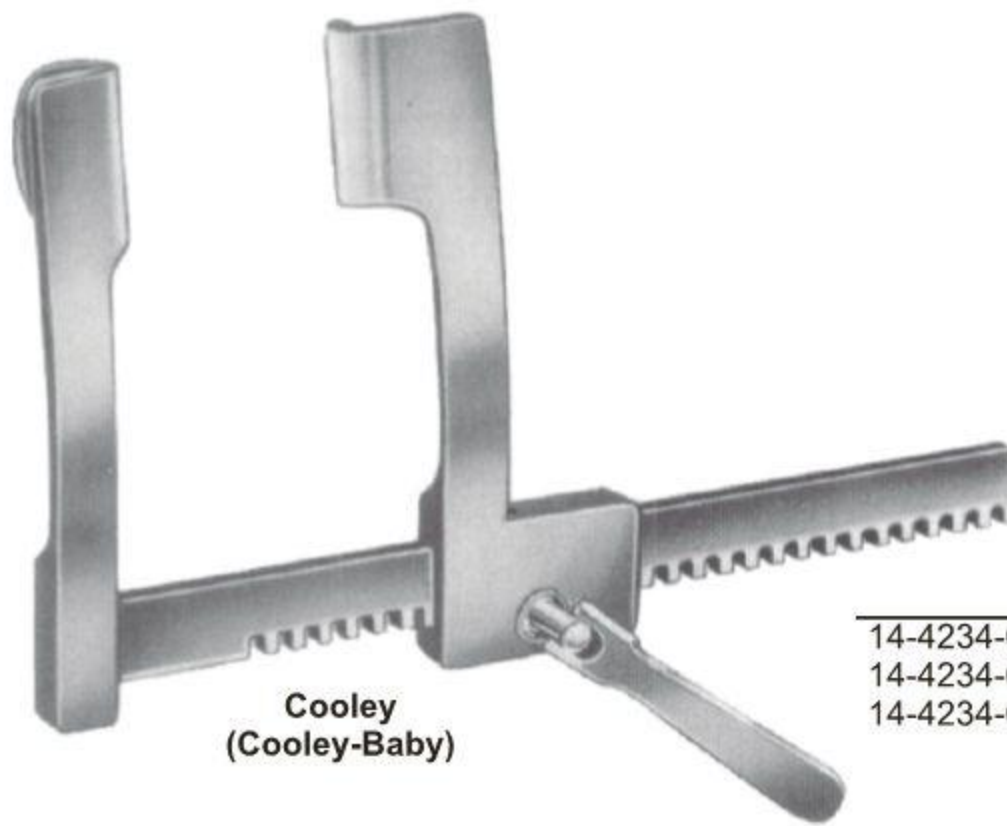

**Cooley
(Cooley-Baby)**

	a	b	c
14-4234-01	15 mm	30 mm	75 mm
14-4234-02	21 mm	45 mm	145 mm
14-4234-03	32 mm	50 mm	190 mm



De Bakey
 14-4235-00
 With 3 Pairs of Blades
 14-4235-01
 14-4235-02
 14-4235-03

Spreader only



14-4235-01
 60 x 60 mm



14-4235-02
 50 x 80 mm



14-4235-03
 40 x 100 mm

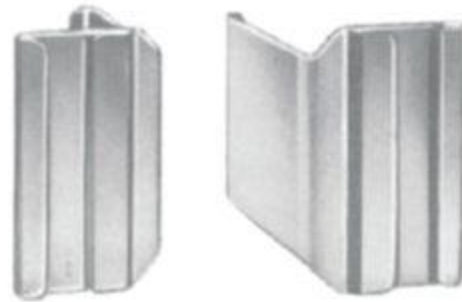

14-4235-04
 80 x 60 mm



14-4235-05
 50 x 66 mm

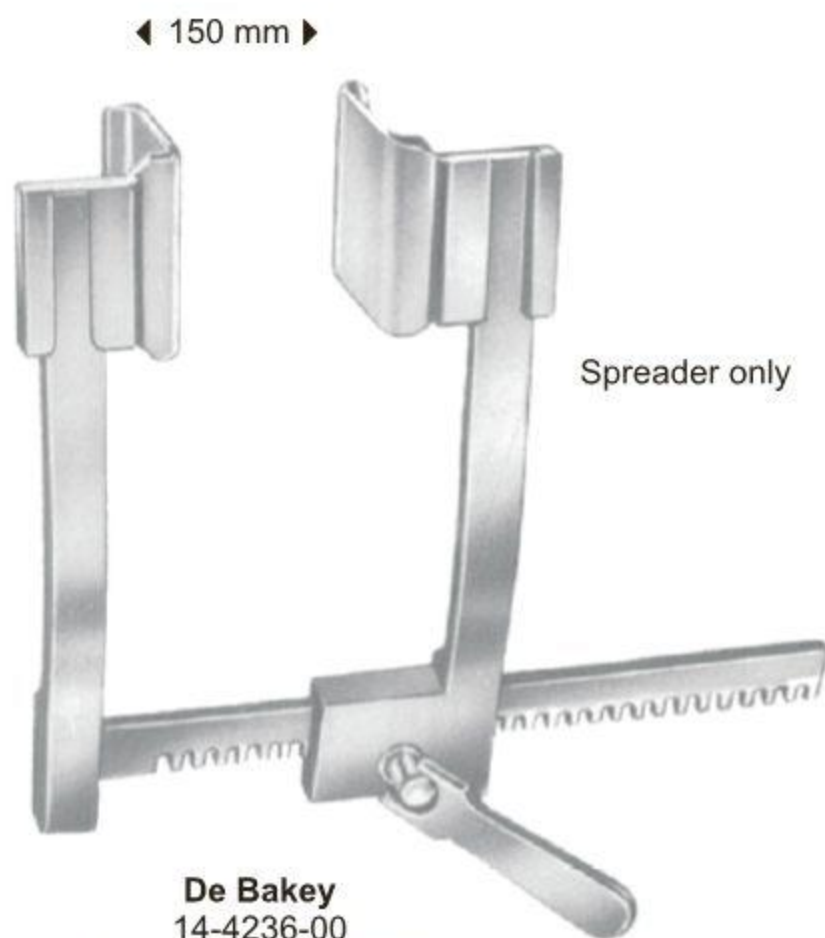

De Bakey
 14-4236-00
 With 3 Pairs of Blades

Spreader only



14-4236-01
 30 x 30 mm



14-4236-02
 40 x 40 mm



14-4236-03
 50 x 50 mm

◀ Fig. 1 15 cm/6" ▶
◀ Fig. 2 20 cm/8" ▶



Morse-Favaloro
Fig. 1 14-4237-01
Fig. 2 14-4237-02

75 x 75 mm

42 x 65 mm

Thoracic Retractor



(Mercedes-Retractor)
14-4238-00
Complete

Rib Spreaders ●— EN
 Rippensperrer ●— DE
 Separadores costales ●— ES

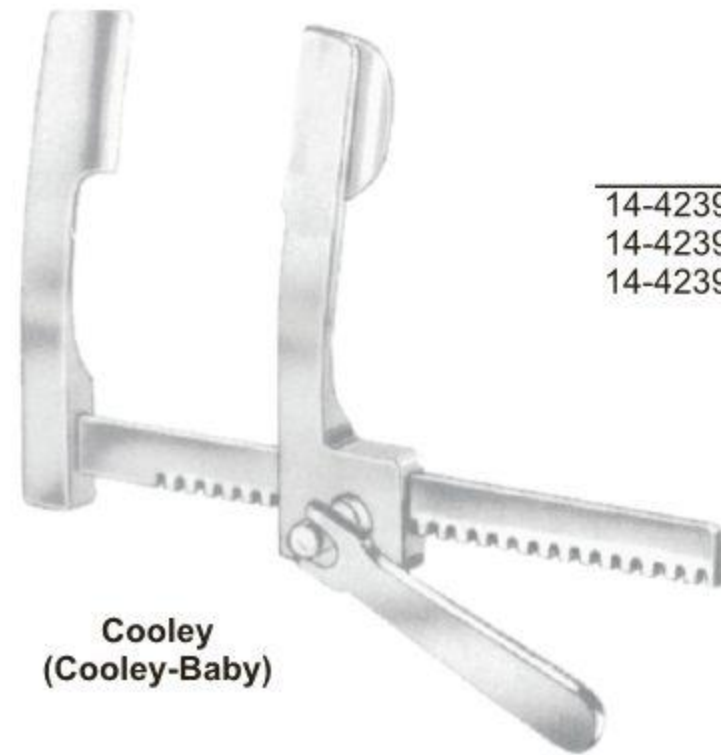

Cooley
(Cooley-Baby)

	a	b	c
14-4239-01	12 mm	17 mm	75 mm
14-4239-02	16 mm	30 mm	105 mm
14-4239-03	37 mm	49 mm	200 mm



Castaneda

	a	b	c
14-4240-01	10.5 mm	32 mm	65 mm
14-4240-02	12 mm	45 mm	70 mm
14-4240-03	15 mm	60 mm	120 mm



Finocchietto-Baby-Haight

	a	b	c
14-4241-01	15 mm	15 mm	75 mm
14-4241-02	31 mm	31 mm	100 mm
14-4241-03			

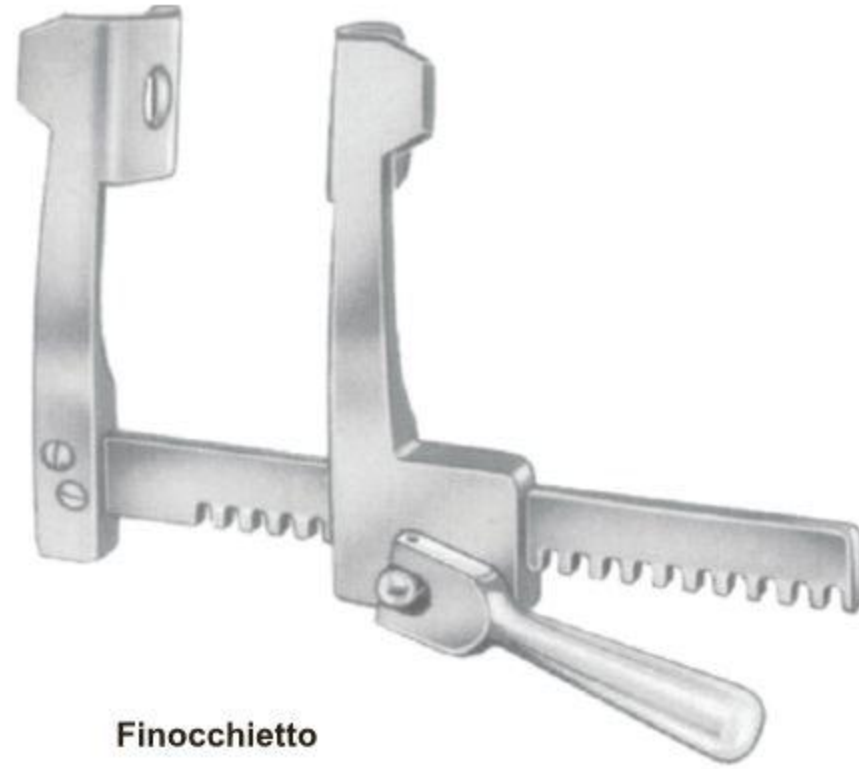

Finocchetto

	a	b	c
14-4242-01	38 mm	44 mm	135 mm
14-4242-02	52 mm	62 mm	135 mm
14-4242-03	85 mm	65 mm	135 mm



Burford
With 2 Pairs of Blades

For Child	a	b	c
	48 mm	42 mm	135 mm
14-4243-00	34 mm	42 mm	135 mm
14-4243-01	65 mm	62 mm	180 mm
	47 mm	62 mm	
14-4243-02	65 mm	62 mm	260 mm
	47 mm	62 mm	
14-4243-03	65 mm	62 mm	300 mm
	47 mm	62 mm	



Lemmon
 14-4244-18
 18 cm/7"



Sellors
 14-4245-19
 19 cm/7½"



Bailey-Baby
 14-4246-14
 14 cm/5½"



Bailey
 14-4247-16
 16 cm/6¼"



Bailey-Gibbon
 14-4248-16
 16 cm/6¼"



Allison
 14-4249-25 25.5 cm/10"
 14-4249-30 30.0 cm/12"

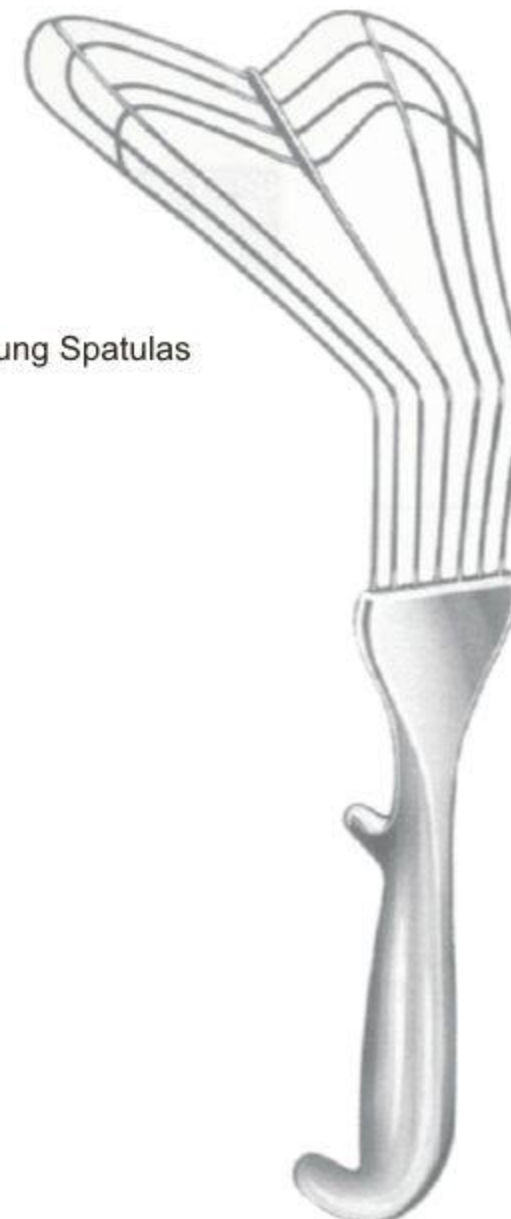

Lung Spatulas

14-4250-30
 30 cm/12"

- EN** Neurosurgery
- DE** Neurochirurgie
- ES** Neuro Cirugía

Page 358 to 388

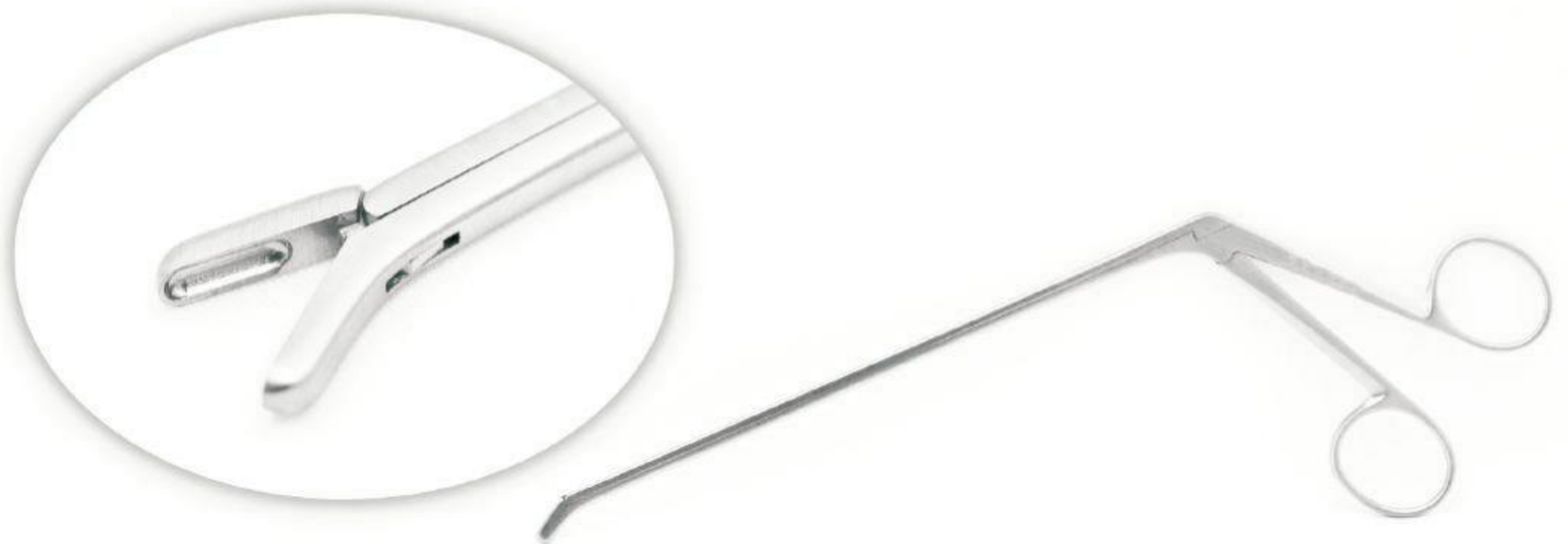

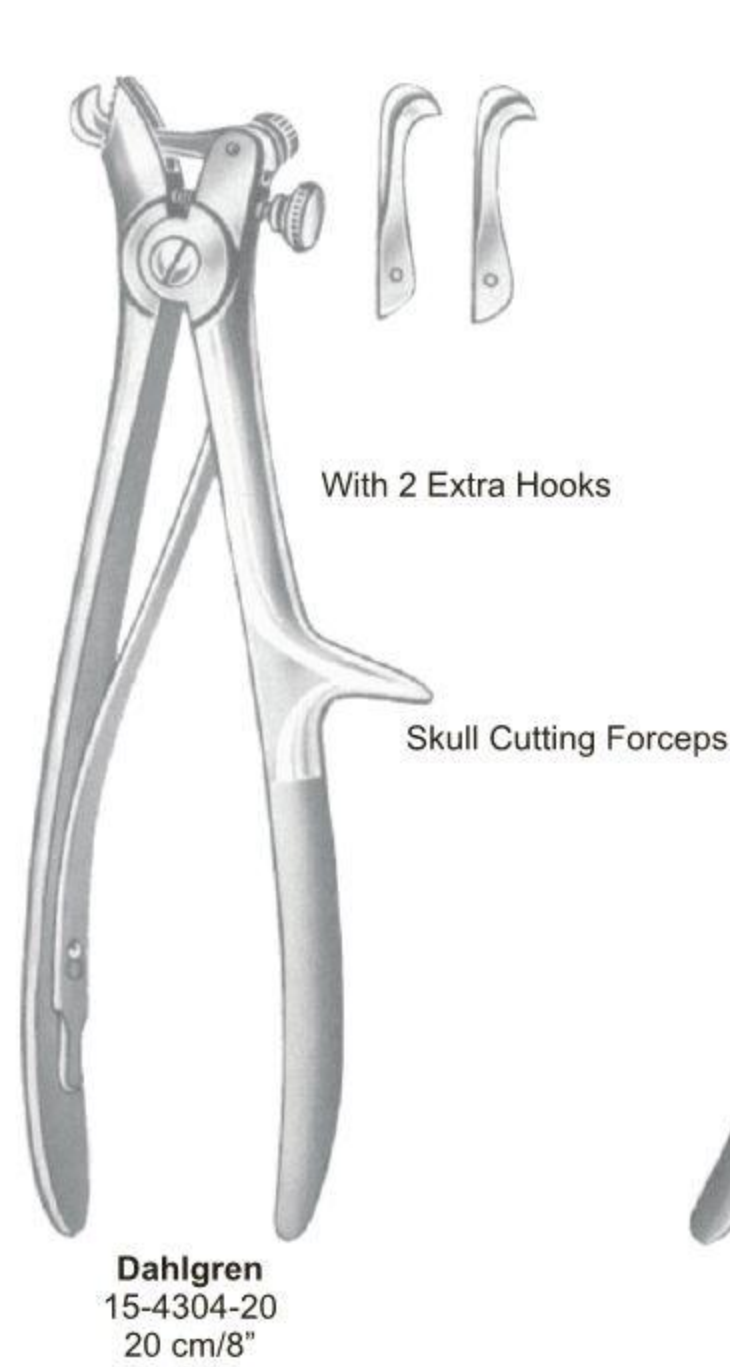



Crutchfield
 15-4306-00



Crutchfield
 15-4307-00



15-4308-00



Crutchfield
 15-4309-00
 Complete With 2 Drills

Applying and Removing Forceps



Raney
15-4310-00
16 cm/6¼"

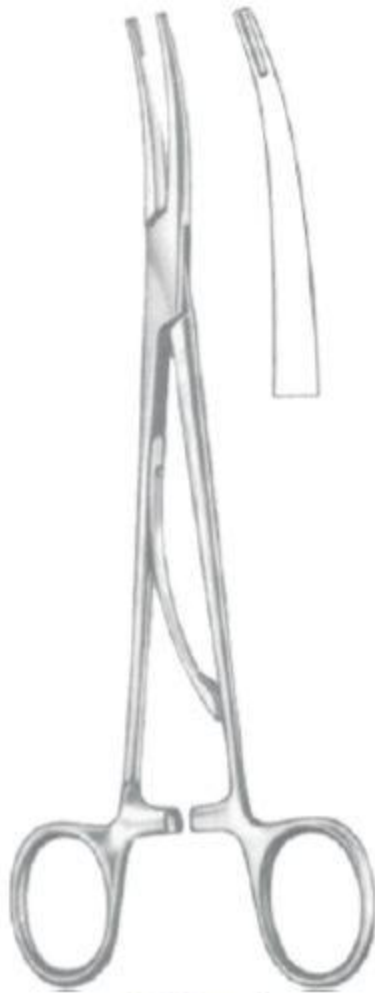

McKenzie
15-4311-15 15 cm/6"
15-4311-19 19 cm/7½"



Olivecrona-Tonnis
15-4312-14



Retractor Only
 15-4313-01
 15 cm/6"

Caspar
 15-4313-00

Retractor Complete With
 1 Blade Each
 15-4313-40
 15-4313-50

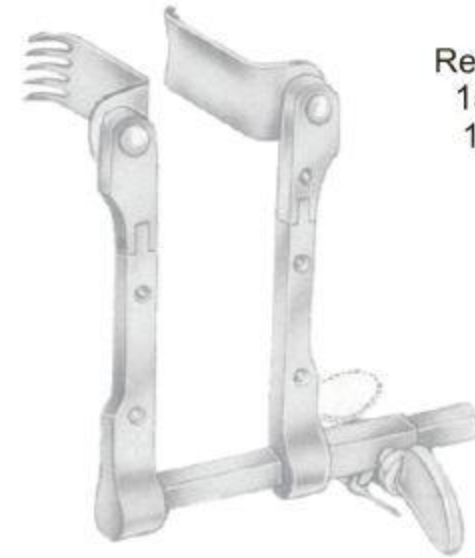

Retractor Only
 15-4314-01
 12 cm/4¾"

Caspar
 15-4314-00

Retractor Complete With
 1 Blade Each
 15-4314-40
 15-4314-50

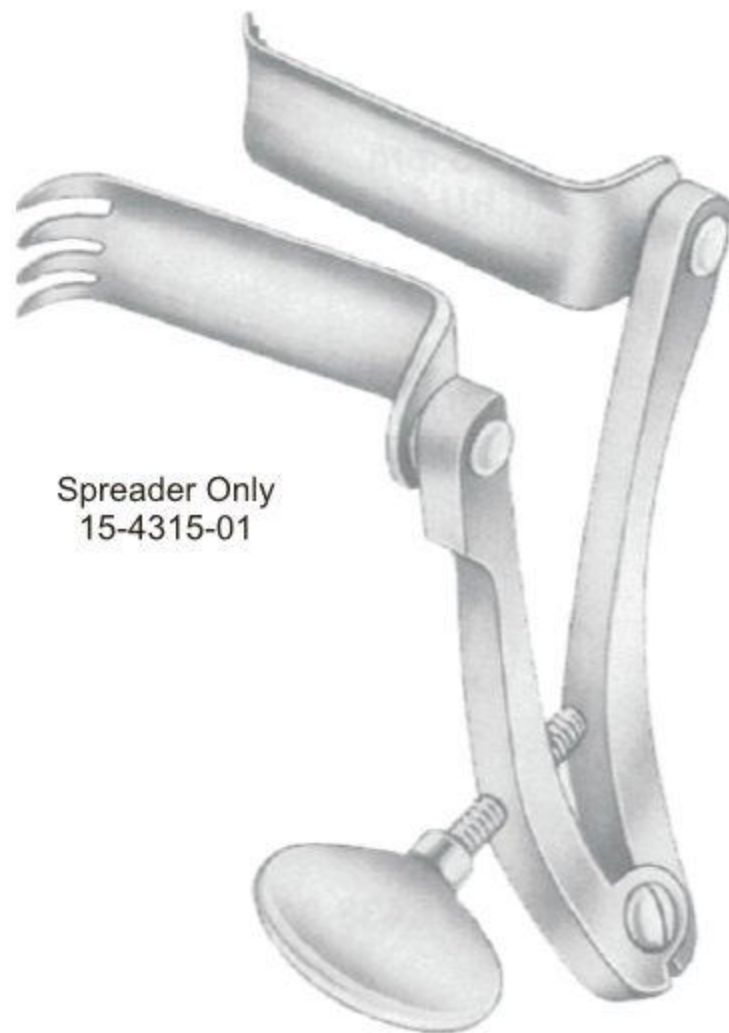

Spreader Only
 15-4315-01

Caspar
 15-4315-00
 Retractors Only
 Spreader Complete With
 1 Blade Each
 15-4315-45
 15-4315-60



Spreader Only
 15-4316-01

Caspar
 15-4316-00
 Spreader Only
 Retractor Complete With
 1 Blade Each
 15-4316-40
 15-4316-60

15-4317-01
15 cm/6"
Retractor only

Caspar
15-4317-00
15-4317-45
15-4317-65
Retractor complete with
1 blade each

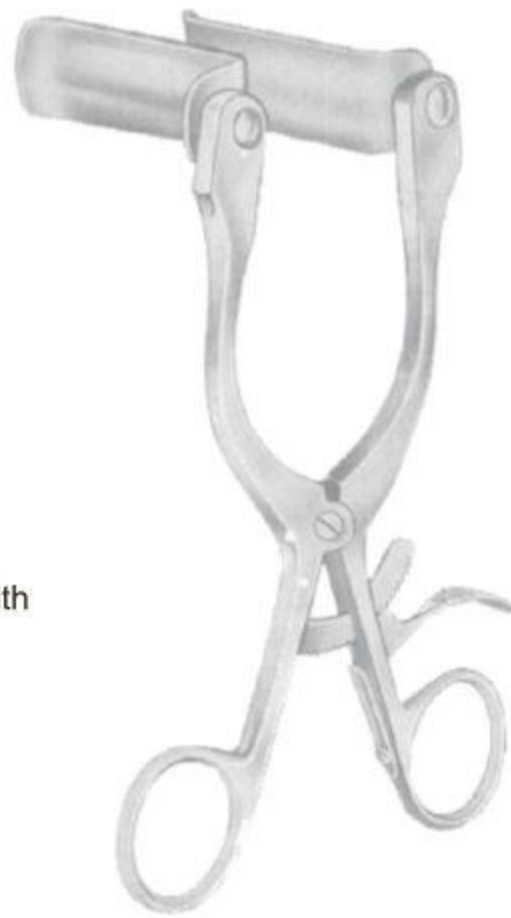

15-4318-01
15 cm/6"
Retractor only

Caspar
15-4318-00
15-4318-45
15-4318-65
Retractor adjustable, con
1 blade each

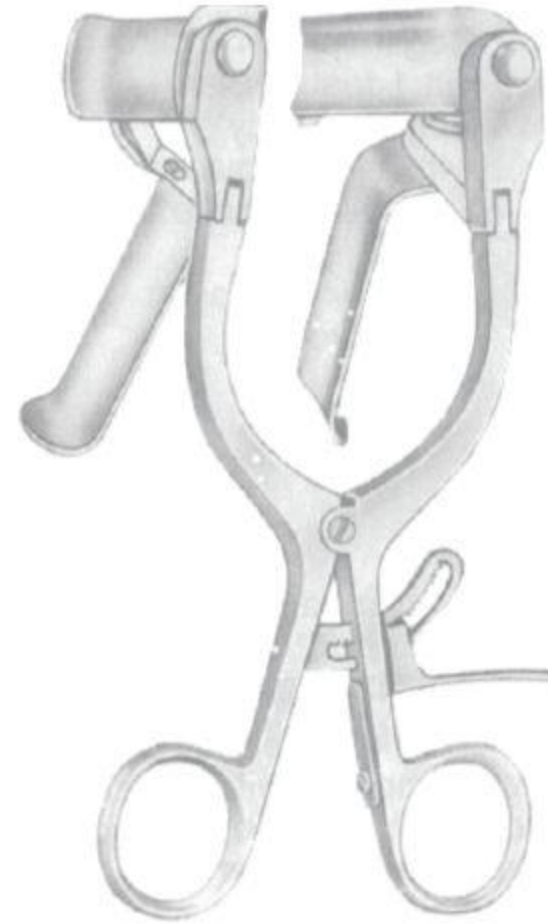

15-4319-01
Retractor only
with 1 fixed blade

Caspar
15-4319-00
Retractor complete,
eith 5 blades

15-4319-40
40 mm



15-4319-45
45 mm



15-4319-50
50 mm



15-4319-55
55 mm



15-4319-60
60 mm





15-4320-01
 Retractor only

Cloward
 15-4320-00
 25 cm/10"
 complete with 5 blades

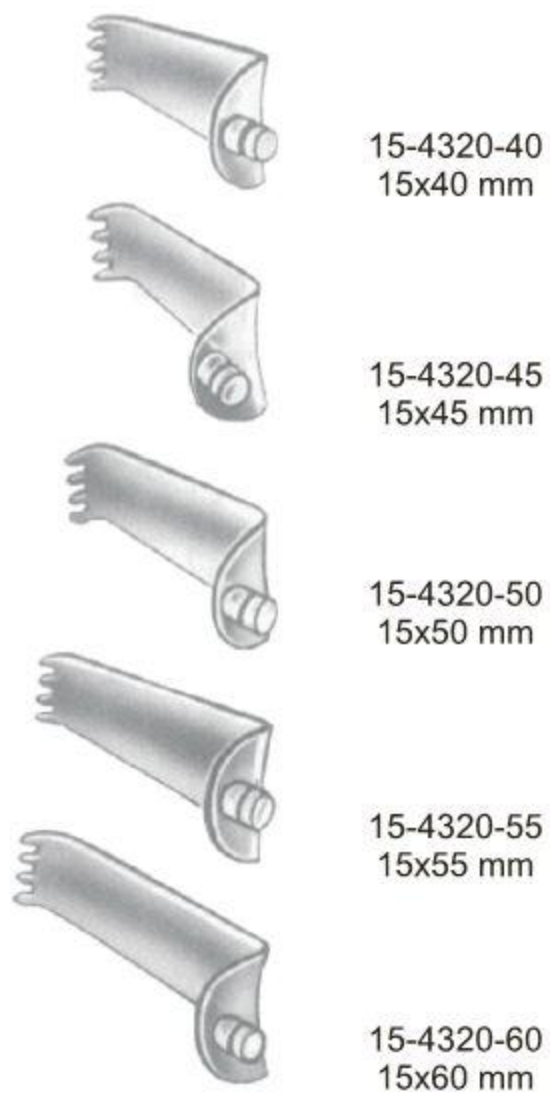

15-4321-01
 Retractor only

Cloward
 15-4321-00
 15 cm/6"
 complete with 5 blades

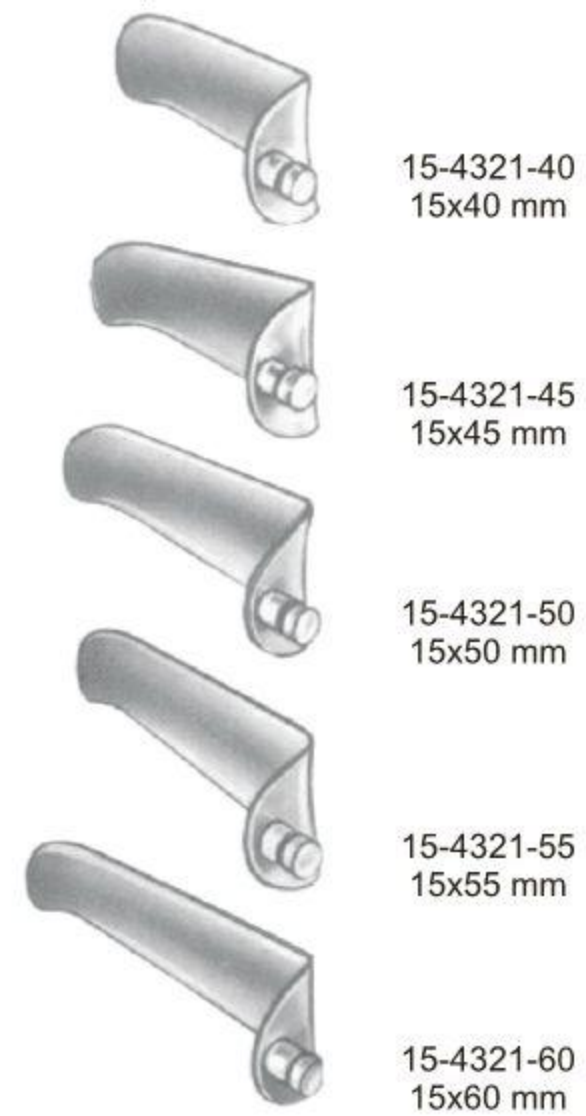



Inge
15-4322-16
16 cm/6¼"



Inge
15-4323-25
27 cm/10¾"



Cloward
15-4324-15
15 cm/6"



Cloward
15-4325-16
16 cm/6¼"



Frame
 15-4326-01

Hey
 15-4327-00
 15-4328-00
 23 cm/9"

Muscle blades



15-4329-50
 20x50 mm



15-4329-60
 20x60 mm



15-4329-70
 20x70 mm

Vertebra-pins



15-4330-50
 50 mm



15-4330-60
 60 mm



15-4330-70
 70 mm



	Left-type	Right-type
50x10 mm	15-4331-01	15-4332-01
60x10 mm	15-4331-02	15-4332-02
70x10 mm	15-4331-03	15-4332-03
50x20 mm	15-4333-01	15-4334-01
60x20 mm	15-4333-02	15-4334-02
70x20 mm	15-4333-03	15-4334-03

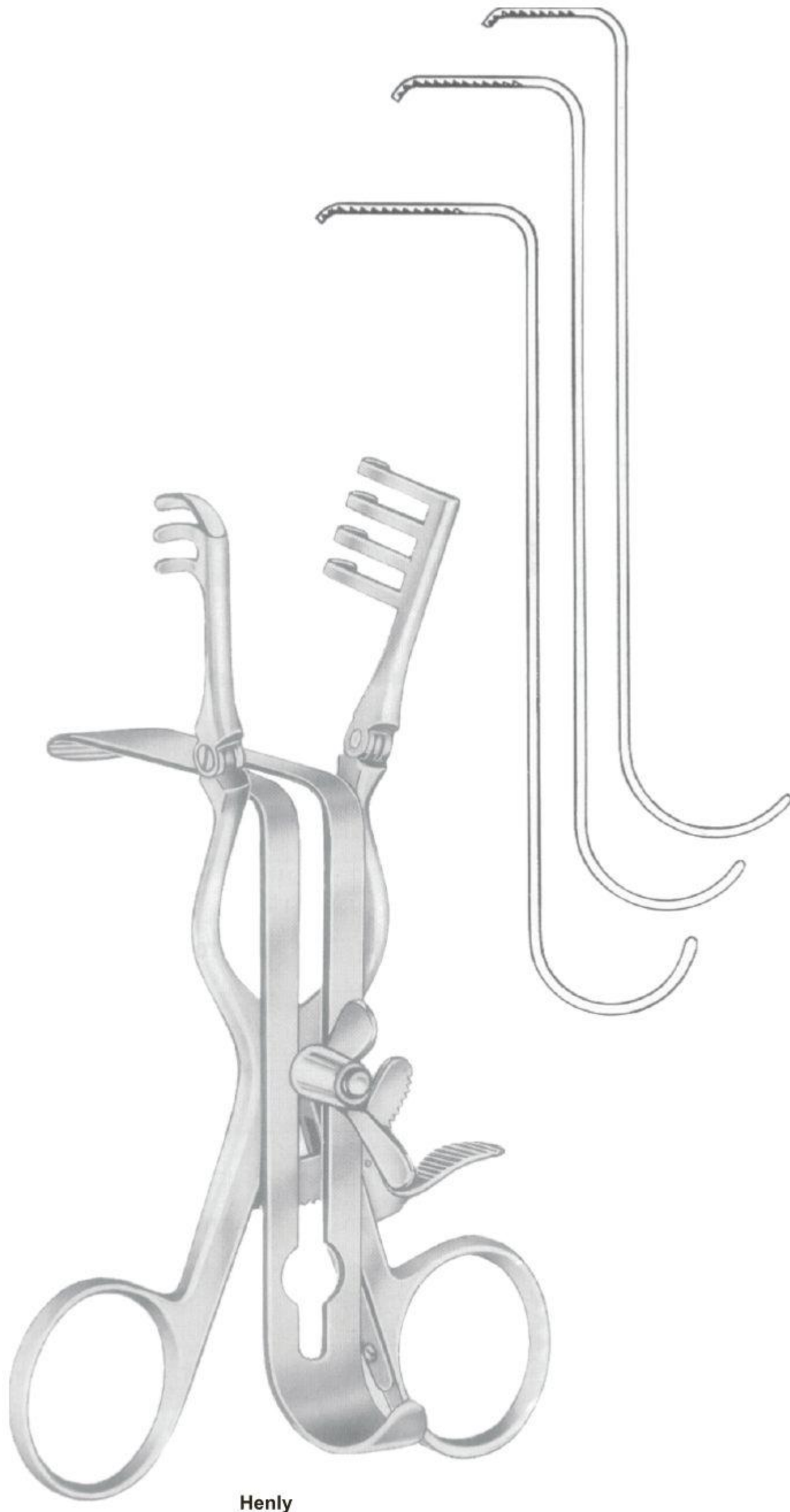

Henly

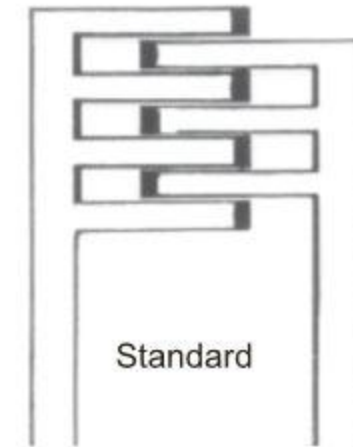

Standard

15-4335-00 Complete 15-4336-00
 14.5 cm/5¾" Consisting of 17 cm/6¾"

15-4335-01 Frame 15-4336-01
 15-4335-21 Centre Blades 15-4336-21
 15-4335-22 15-4336-22
 15-4335-23 15-4336-23

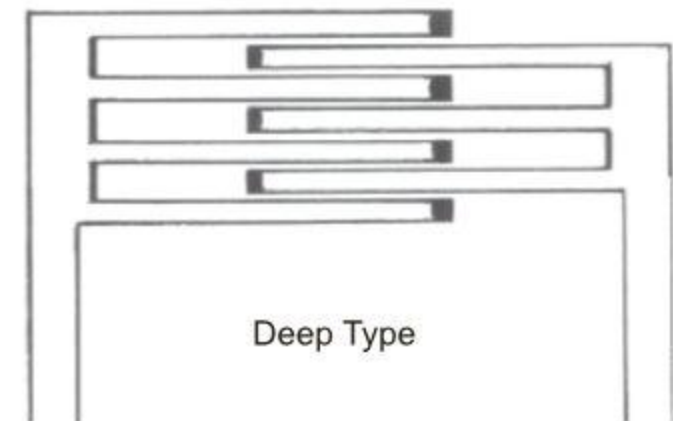

Deep Type

15-4337-00 Complete 15-4338-00
 14.5 cm/5¾" Consisting of 17 cm/6¾"

15-4337-01 Centre Blades 15-4338-01
 15-4337-21 15-4338-21
 15-4337-22 15-4338-22
 15-4337-23 15-4338-23



Davis
15-4339-24
24.5 cm/9 3/4"



Toennis
15-4340-25
25 cm/10"



Frazier
15-4341-15



Hoer
15-4342-15



Hoer
15-4343-15

15 cm/6"



Love-Adson
15-4344-16
16 cm/6 1/2"

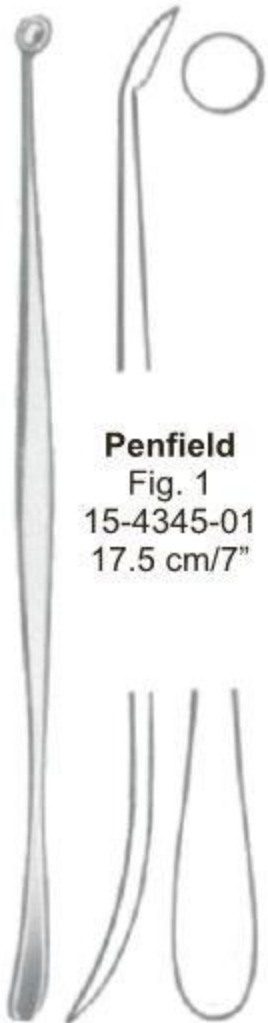

Penfield
Fig. 1
15-4345-01
17.5 cm/7"



Penfield
Fig. 2
15-4346-02
19.5 cm/7 3/4"



Penfield
Fig. 3
15-4347-03
19.5 cm/7 3/4"



Penfield
Fig. 4
15-4348-04
21.5 cm/8 1/2"



Penfield
Fig. 5
15-4349-05
29 cm/11 1/2"



Sachs
 15-4350-21
 21 cm/8¼"

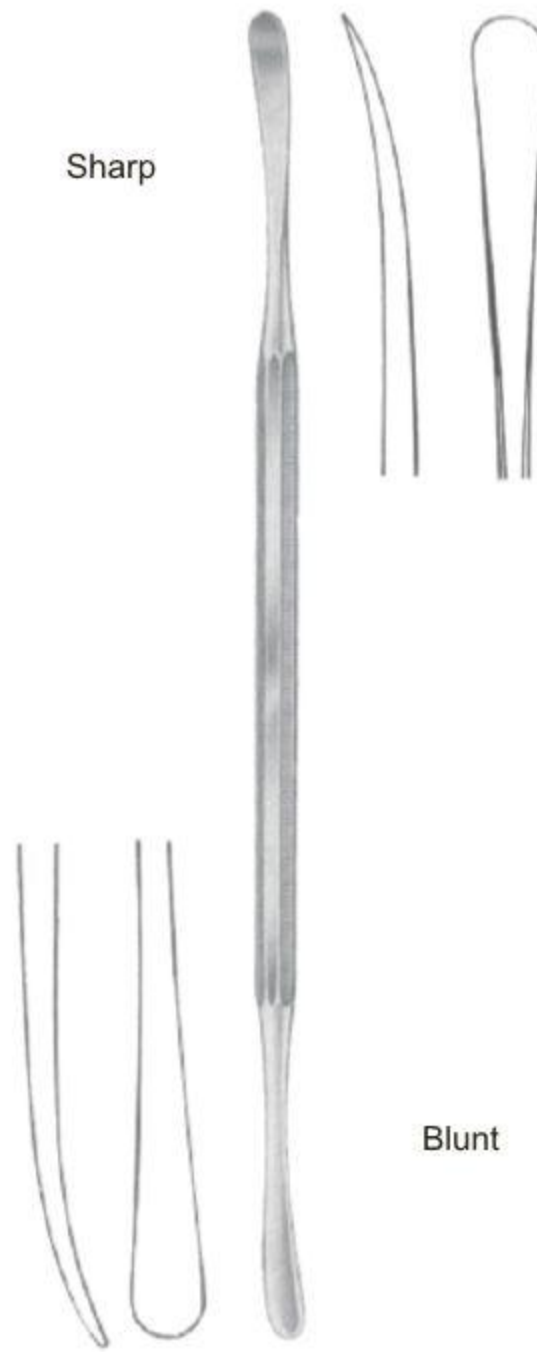

Sharp

Blunt

15-4351-22
 22 cm/8¼"



Woodsen
 15-4352-25
 25 cm/10"



Fragner
 15-4353-20
 20 cm/8"



Fragner
 15-4354-20
 20 cm/8"



Sachs
 15-4355-21
 21 cm/8¼"



Milligan
15-4356-21 21 cm/8¼"



Olivecrona
15-4357-18 18 cm/7"
15-4357-24 24 cm/9½"



Olivecrona
15-4358-19 19.5 cm/7¾"
15-4358-24 24 cm/9½"



Horsley
15-4359-20 20 cm/8"



Sachs
15-4360-21 21 cm/8¼"



Cushing
 17 cm/6¾"
 20 cm/8"
 28 cm/11"

15-4361-17
 15-4361-20
 15-4361-28

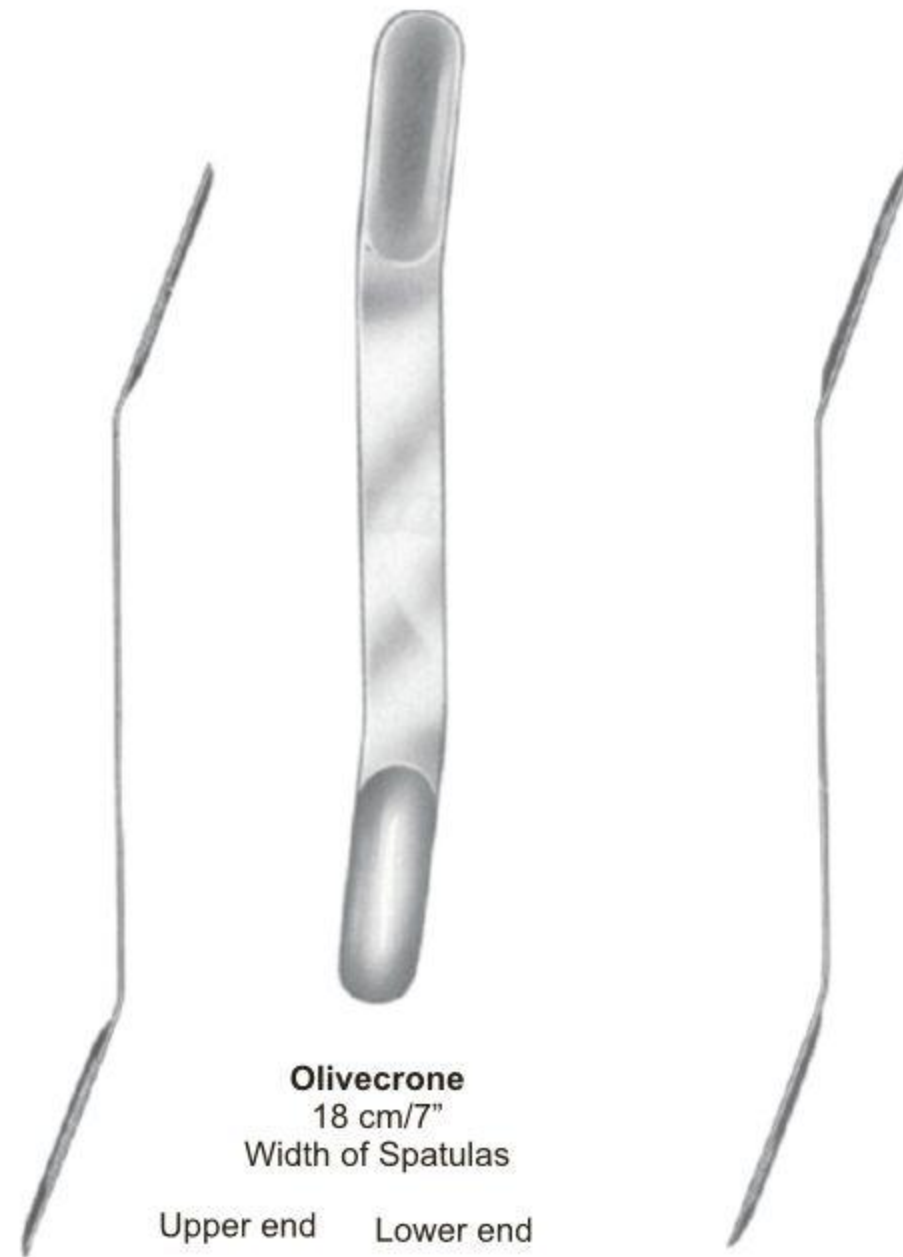

Olivecrona
 18 cm/7"
 Width of Spatulas

	Upper end	Lower end	
Concave	mm	mm	Convex
15-4362-01	7	9	15-4363-01
15-4362-02	11	13	15-4363-02
15-4362-03	15	18	15-4363-03
15-4362-04	18	22	15-4363-04



Width of Spatulas

Upper end		Lower end
mm		mm
7	15-4364-08	8
10	15-4364-11	11
13	15-4364-13	14
16	15-4364-17	17
19	15-4364-20	20
22	15-4364-25	22

Heifetz
 20 cm/8"



Width of Spatulas

15-4365-08	8
15-4365-11	11
15-4365-13	14
15-4365-17	17

Length of Spatulas

Heifetz
 15.5 cm/6"



18 cm/7"

Width of spatulas

Upper end	Lower end	
mm	mm	
7	9	15-4366-09
11	13	15-4366-13
15	18	15-4366-18
18	22	15-4366-22



20 cm/8"
12 mm 15-4367-12
17 mm 15-4367-17



20 cm/8"
14 mm 15-4368-14
17 mm 15-4368-17
20 mm 15-4368-20



15-4369-01
19cm/7½"



Love
15-4370-02
19 cm/7½"



15-4371-03



Love
15-4372-21
21 cm/8¼"

Length of spatulas



70 mm
 3 mm 15-4373-03

100 mm
 15-4374-03



5 mm 15-4373-05

15-4374-05



7 mm 15-4373-07

15-4374-07

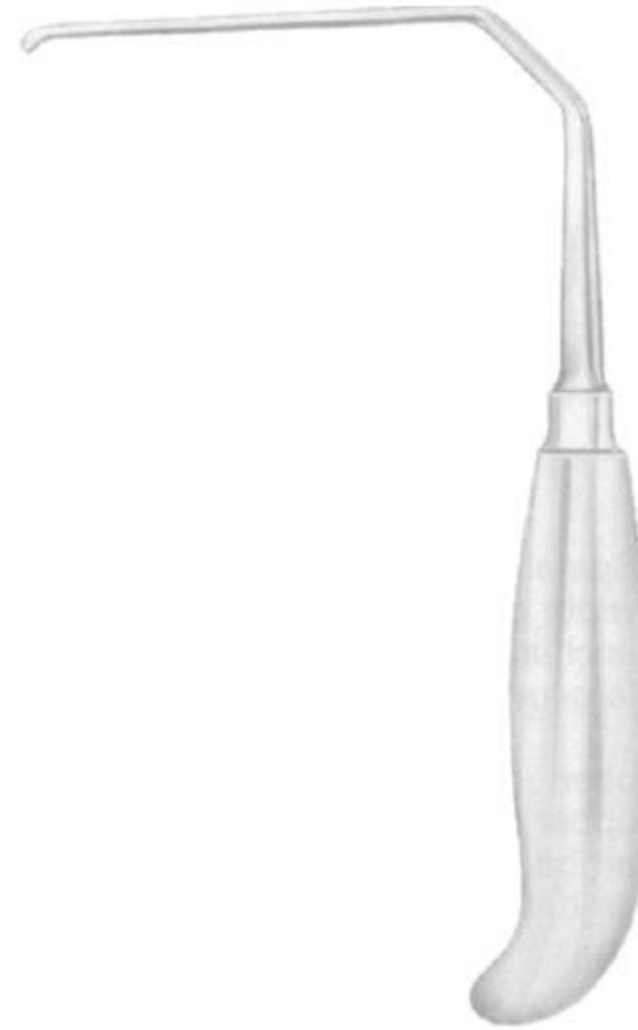

Love



Scoville
 23 cm/9"

7 mm 15-4375-07
 9 mm 15-4375-09



Holsher
 7mm 15-4376-07
 9mm 15-4376-09
 24 cm/9½"



8 mm 15-4377-08
 13 mm 15-4377-13



Taylor
 30x 70 mm 15-4378-07 17 cm/6¾"
 30x100 mm 15-4378-10 17 cm/6¾"



Oldberg
 21 cm/8¼"



15-4379-01



15-4379-02



15-4379-03



15-4379-04



Cushing
 15-4380-19 19 cm/7 3/4"
 15-4380-28 28 cm/11"



Smithwick
 15-4381-17 17 cm/6 1/2"
 15-4381-21 21 cm/8 1/4"



Cushnig
 15-4382-14
 14 cm/5 1/2"



Adson
 20 cm/8"



15-4383-01



15-4383-02



Cloward
15-4384-16
16 cm/6 1/2"



Hoen
15-4385-22
22 cm/8 3/4"



Dandy
15-4386-01
20 cm/8"



Dandy
15-4387-02
20 cm/8"



Dandy
15-4388-03
20 cm/8"



Smithwick
15-4389-29
29 cm/11 3/4"



Scoville
15-4390-30
30 cm/12"



Scoville
15-4391-30
30 cm/12"



Graham
 15-4392-16
 16.5 cm/6½"



Toennis
 15-4393-15
 15 cm/6"



Frazier
 15-4394-13 13 cm/5"
 15-4394-18 18 cm/7"



Toennis
 15-4395-13 13 cm/5"
 15-4395-18 18 cm/7"



Olivecrona
 15-4396-23
 23 cm/9"



Olivecrona
 15-4397-20
 20.5 cm/8"



Ferris-Smith-Kerrison

		Width of Bite	Length of Shaft		
			15 cm/6"	20 cm/8"	18 cm/7"
Cutting Upward		0.6 mm			15-4404-00
		1 mm			15-4404-01
		2 mm			15-4404-02
		3 mm	15-4398-03	15-4401-03	15-4404-03
		4 mm			15-4404-04
		5 mm	15-4398-05	15-4401-05	15-4404-05
Cutting Upward 40°		0.6 mm			15-4405-00
		1 mm			15-4405-01
		2 mm			15-4405-02
		3 mm	15-4399-03	15-4402-03	15-4405-03
		4 mm			15-4405-04
		5 mm	15-4399-05	15-4402-05	15-4405-05
Cutting Downwards		0.6 mm			15-4406-00
		1 mm			15-4406-01
		2 mm			15-4406-02
		3 mm	15-4400-03	15-4403-03	15-4406-03
		4 mm			15-4406-04
		5 mm	15-4400-05	15-4403-05	15-4406-05



Ferris-Smith-Kerrison

		Width of Bite		Length of Shaft		
Cutting Upward		15 cm/6"		20 cm/8"		18 cm/7"
		3 mm	15-4407-03	15-4410-03	15-4413-03	
		5 mm	15-4407-05	15-4410-05	15-4413-05	
Cutting Upward 40°		15 cm/6"		20 cm/8"		18 cm/7"
		3 mm	15-4408-03	15-4411-03		
		5 mm	15-4408-05	15-4411-05		
Cutting Downward		15 cm/6"		20 cm/8"		18 cm/7"
		3 mm	15-4409-03	15-4412-03	15-4414-03	
		5 mm	15-4409-05	15-4412-05	15-4414-05	



Love-Kerrison

		Width of Bite		Length of Shaft	
		2 mm	15 cm/6"	20 cm/8"	18 cm/7"
Cutting Upward		2 mm			15-4419-02
		3 mm	15-4415-03	15-4417-03	15-4419-03
		4 mm	15-4415-04	15-4417-04	15-4419-04
		5 mm	15-4415-05	15-4417-05	15-4419-05
		6 mm			15-4419-06
Cutting Upward 40°		2 mm			15-4420-02
		3 mm			15-4420-03
		4 mm			15-4420-04
		5 mm			15-4420-05
		6 mm			15-4420-06
Cutting Downward		2 mm			15-4421-02
		3 mm	15-4416-03	15-4418-03	15-4421-03
		4 mm	15-4416-04	15-4418-04	15-4421-04
		5 mm	15-4416-05	15-4418-05	15-4421-05
		6 mm			15-4421-06
Cutting Upward 40°		2 mm			15-4422-02
		3 mm			15-4422-03
		4 mm			15-4422-04
		5 mm			15-4422-05
		6 mm			15-4422-06



		Width of Bite	Length of Shaft	
Cutting Upward		3 mm	15 cm/6"	20 cm/8"
		5 mm	15-4423-03	15-4426-03 15-4426-05
Cutting Upward 40°		3 mm	15-4424-03	15-4427-03
		5 mm	15-4424-05	15-4427-05
Cutting Downward		3 mm	15-4425-03	15-4428-03
		5 mm	15-4425-05	15-4428-05



	Length Of Shaft			
Cushing 2 x 10 cm	5"/13 cm	15-4429-01	15-4430-02	15-4431-03
	6"/15 cm	15-4429-01	15-4430-02	15-4431-03
	7"/18 cm	15-4429-01	15-4430-02	15-4431-03
Love-Grunwald 3 x 10 cm	5"/13 cm	15-4429-01	15-4430-02	15-4431-03
	6"/15 cm	15-4429-01	15-4430-02	15-4431-03
	7"/18 cm	15-4429-01	15-4430-02	15-4431-03
Spurling 4 x 10 cm	5"/13 cm	15-4429-01	15-4430-02	15-4431-03
	6"/15 cm	15-4429-01	15-4430-02	15-4431-03
	7"/18 cm	15-4429-01	15-4430-02	15-4431-03



With Suction/Irrigation Device

	Length Of Shaft			
Cushing 2 x 10 cm	5"/13 cm	15-4432-01	15-4433-02	15-4434-03
	6"/15 cm	15-4432-01	15-4433-02	15-4434-03
	7"/18 cm	15-4432-01	15-4433-02	15-4434-03
Love-Grunwald 3 x 10 cm	5"/13 cm	15-4432-01	15-4433-02	15-4434-03
	6"/15 cm	15-4432-01	15-4433-02	15-4434-03
	7"/18 cm	15-4432-01	15-4433-02	15-4434-03
Spurling 4 x 10 cm	5"/13 cm	15-4432-01	15-4433-02	15-4434-03
	6"/15 cm	15-4432-01	15-4433-02	15-4434-03
	7"/18 cm	15-4432-01	15-4433-02	15-4434-03



Ferris-Smith

Width Of Jaw



2 x 10 mm	15-4435-01	15-4436-02	15-4437-03
3 x 10 mm	15-4435-01	15-4436-02	15-4437-03
4 x 10 mm	15-4435-01	15-4436-02	15-4437-03

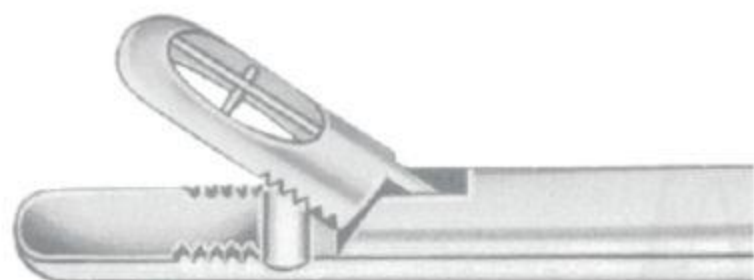

Serrated and Fenestrated Jaws

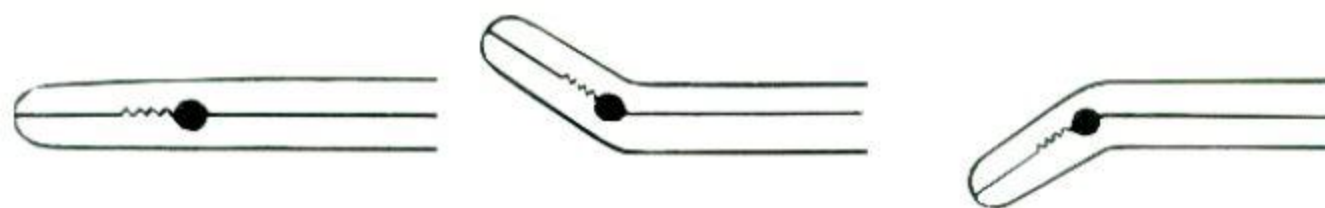

Width Of Jaw	Length Of Shaft			
mm	14 cm/5 1/2"	15-4438-01	15-4438-02	15-4438-03
	16 cm/6 1/4"	15-4439-01	15-4439-02	15-4439-03
2 x 12	14 cm/5 1/2"	15-4440-01	15-4440-02	15-4440-03
	16 cm/6 1/4"	15-4441-01	15-4441-02	15-4441-03
3 x 12	14 cm/5 1/2"	15-4442-01	15-4442-02	15-4442-03
	16 cm/6 1/4"	15-4443-01	15-4443-02	15-4443-03
4 x 14	14 cm/5 1/2"	15-4444-01	15-4444-02	15-4444-03
	16 cm/6 1/4"	15-4445-01	15-4445-02	15-4445-03
5 x 14	14 cm/5 1/2"	15-4446-01	15-4446-02	15-4446-03
	16 cm/6 1/4"	15-4447-01	15-4447-02	15-4447-03
6 x 16	14 cm/5 1/2"			
	16 cm/6 1/4"			



Ø 3.5 mm

Yasargil
15-4448-35
19.5 cm/7¾"



Ø 6.5 mm

Oldberg
15-4449-65
18 cm/7"



Ø 9 mm

Landolt
15-4450-90
21 cm/8¼"

Tumor Grasping Forceps Blunt

Laminectomy Rongeurs ●— EN
 Laminektomie-Zangen ●— DE
 Pinzas cortantes para laminectomía ●— ES



Weil-Blakesley



15-4451-01	15-4451-02	15-4451-03	15-4451-04	15-4451-05
15-4452-01	15-4452-02	15-4452-03	15-4452-04	15-4452-05



15-4453-01	15-4453-02	15-4453-03	15-4453-04	15-4453-05





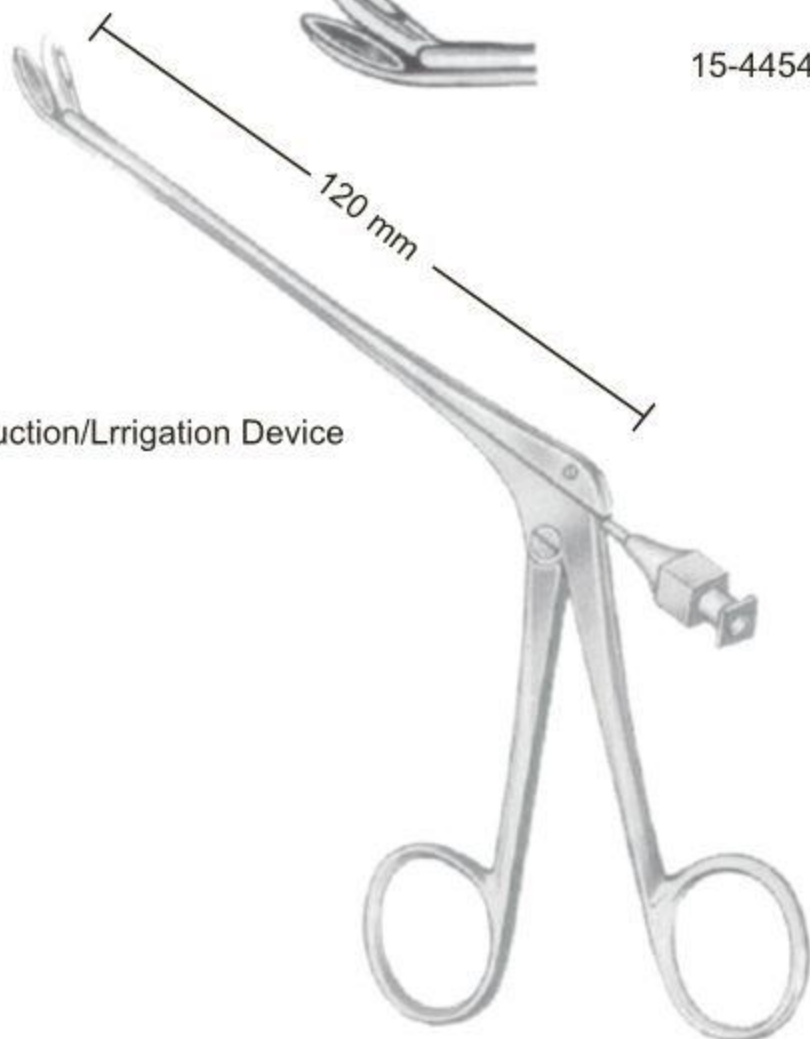

15-4454-01	15-4454-02	15-4454-03	15-4454-04	15-4454-05



With Suction/Irrigation Device

Weil-Blakesley



-  15-4455-01
5 x 4 mm
-  15-4455-02
5 x 4 mm
-  15-4455-03
5 x 3.5 mm
-  15-4455-04
5 x 3.5 mm

**Hajek
(Hajek-Kofler)**
14 cm/5½"

360° Turnable



Hajek-Kofler
15-4456-16
16 cm/6½"

- EN** Ophthalmology
- DE** Ophthalmologie
- ES** Oftalmología

Page 389 to 419



EN —● Eye Speculas
DE —● Lidsperrer
ES —● Espéculos ojo



Weiss
Children 16-4501-07
7 cm/2¾"
Adults 16-4502-09
9 cm/3½"



Weiss
Children 16-4503-07
7 cm/2¾"
Adults 16-4504-09
9 cm/3½"



Park
16-4505-08
8 cm/3¼"



Park-Guyton
16-4506-08
8 cm/3¼"



Park-Maumenee
16-4507-08
8 cm/3¼"



Barraquer (Colibri)
Children 16-4508-03
3 cm/1¼"
Adults 16-4509-04
4 cm/1½"



Barraquer
16-4510-04
4 cm/1½"



Bowman
16-4511-07
7 cm/2¾"



Sauer
16-4512-03
3 cm/1¼"



Goldstein
16-4513-03
3 cm/1¼"



Pley
16-4514-06
6 cm/2¼"

For left eye



Arruga
16-4515-07
7 cm/2¾"

For right eye



Arruga
16-4516-07
7 cm/2¾"

Eye Speculas ●— EN
 Lidsperrer ●— DE
 Espéculos ojo ●— ES



Mellinger-Axenfeld
 16-4517-07
 7 cm/2 3/4"



Mellinger-Axenfeld
 16-4518-07
 7 cm/2 3/4"



Children
 16-4519-05
 5 cm/2 3/4"
Mellinger
 Adults
 16-4520-07
 7 cm/2 3/4"



Children
 16-4521-05
 5 cm/2"
Mellinger Beard
 Adults
 16-4522-07
 7 cm/2 3/4"



Knapp Clark
 16-4523-08
 8 cm/3 1/4"



Children
 16-4524-06
 6 cm/2 1/2"
Graefe
 Adults
 16-4525-09
 9 cm/3 1/2"



Lancaster
 16-4526-08
 8 cm/3 1/4"



Children
 16-4527-07
 7 cm/2 3/4"
Williams
 Adults
 16-4528-08
 8 cm/3 1/4"



Lister-Burch
 16-4529-08
 8 cm/3 1/4"



Weiss
 16-4530-08
 8 cm/3 1/4"



Murdock
 16-4531-05
 5 cm/2"



Mueller
 16-4532-07
 7 cm/2 3/4"



Critchett
 16-4533-06
 6 cm/2 1/2"



Castroviejo
 16-4534-08
 8 cm/3 1/4"



Schepens
16-4535-13
13 cm/5"



Desmarres
16-4536-13
13 cm/5"



8 mm

Conway
16-4537-13
13 cm/5"



Desmarres
13 cm/5"



16-4538-12
12 mm

16-4538-14
14 mm

16-4538-16
16 mm

16-4538-18
18 mm

Lid plate



Jaeger
16-4539-11
11 cm/4½"

Eye Knives ●— EN
 Eye Messer ●— DE
 Cuchillos ojo ●— ES



Graefe



Graefe-Arruga

Deutschmann

Wheeler



Jaeger
16-4544-01



16-4544-02



16-4544-03



16-4544-04



16-4545-01



16-4545-02



16-4545-03



16-4545-04



16-4546-01



16-4546-02



16-4546-03



16-4546-04



16-4547-01



16-4547-02



16-4547-03



16-4547-04

Jaeger-Grieshaber



16-4548-01



16-4548-02



16-4548-03



16-4548-04

Jaeger-Grieshaber

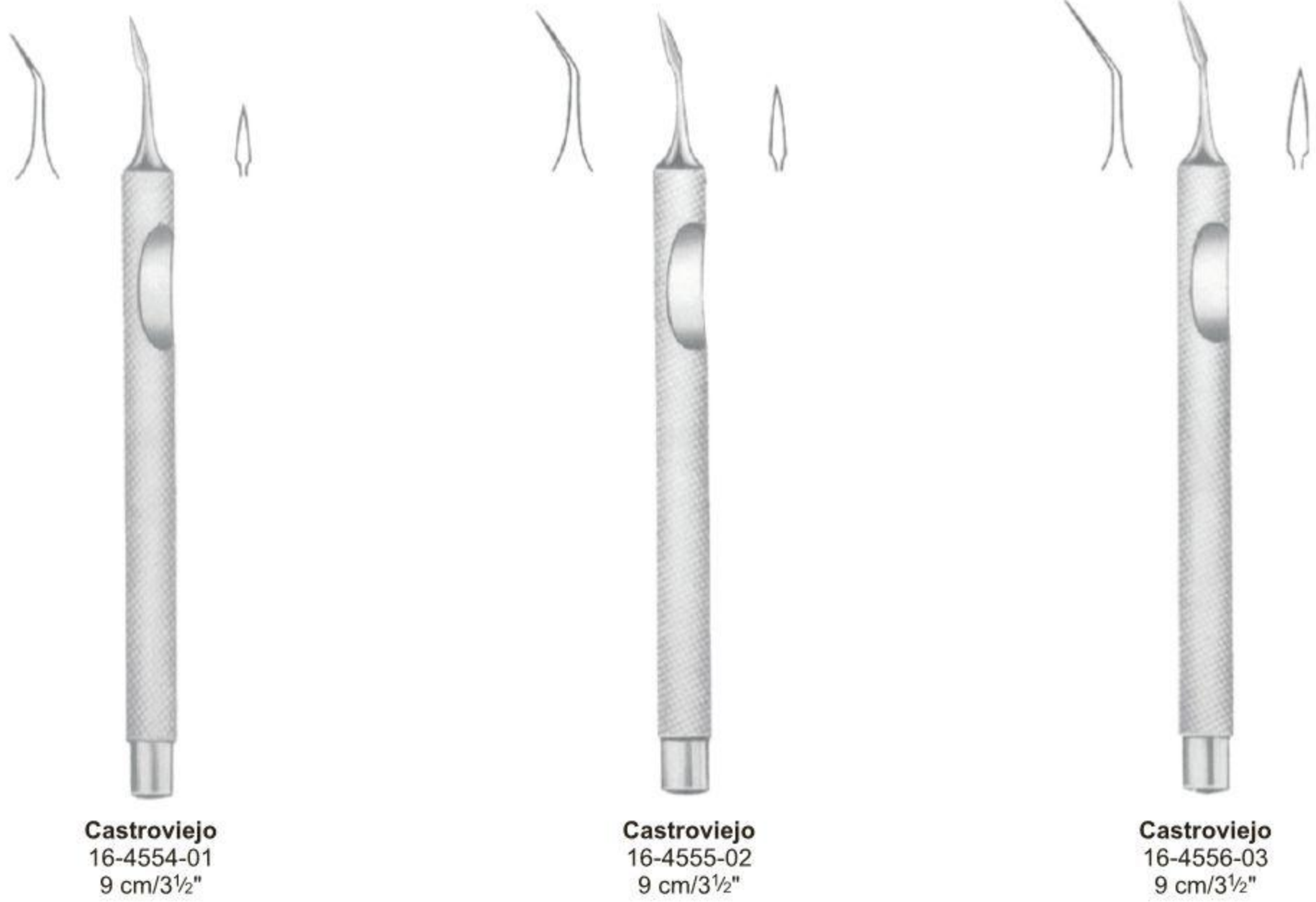



Mod. Hamburg
16-4557-12



Graefe
16-4558-13



16-4559-01



Weber
16-4559-02



16-4559-03



Bowman
16-4560-04
0.4 mm



Bowman
16-4560-05
0.5 mm



Bowman
16-4560-06
0.6 mm



Bowman
16-4560-07
0.7 mm



Bowman
16-4560-08
0.8 mm



Left **Bowman** Right
16-4561-01 16-4561-02



16-4562-01



Knapp
16-4562-02



16-4562-03



16-4563-05
5 mm



Ziegler
16-4563-06
6 mm



16-4563-07
7 mm



Dean
16-4564-13



Zigler
16-4565-11
3½ mm



Sato
16-4566-12



Sichel
16-4567-13



Graefe
16-4568-13



Graefe
16-4569-13



16-4570-01



Kuhnt
16-4571-02



16-4572-03



16-4573-04



Paton
16-4574-12



Elsching
16-4575-13



Took
16-4576-12



16-4577-01



Desmarres
16-4578-02



16-4579-03



Gill
16-4580-12

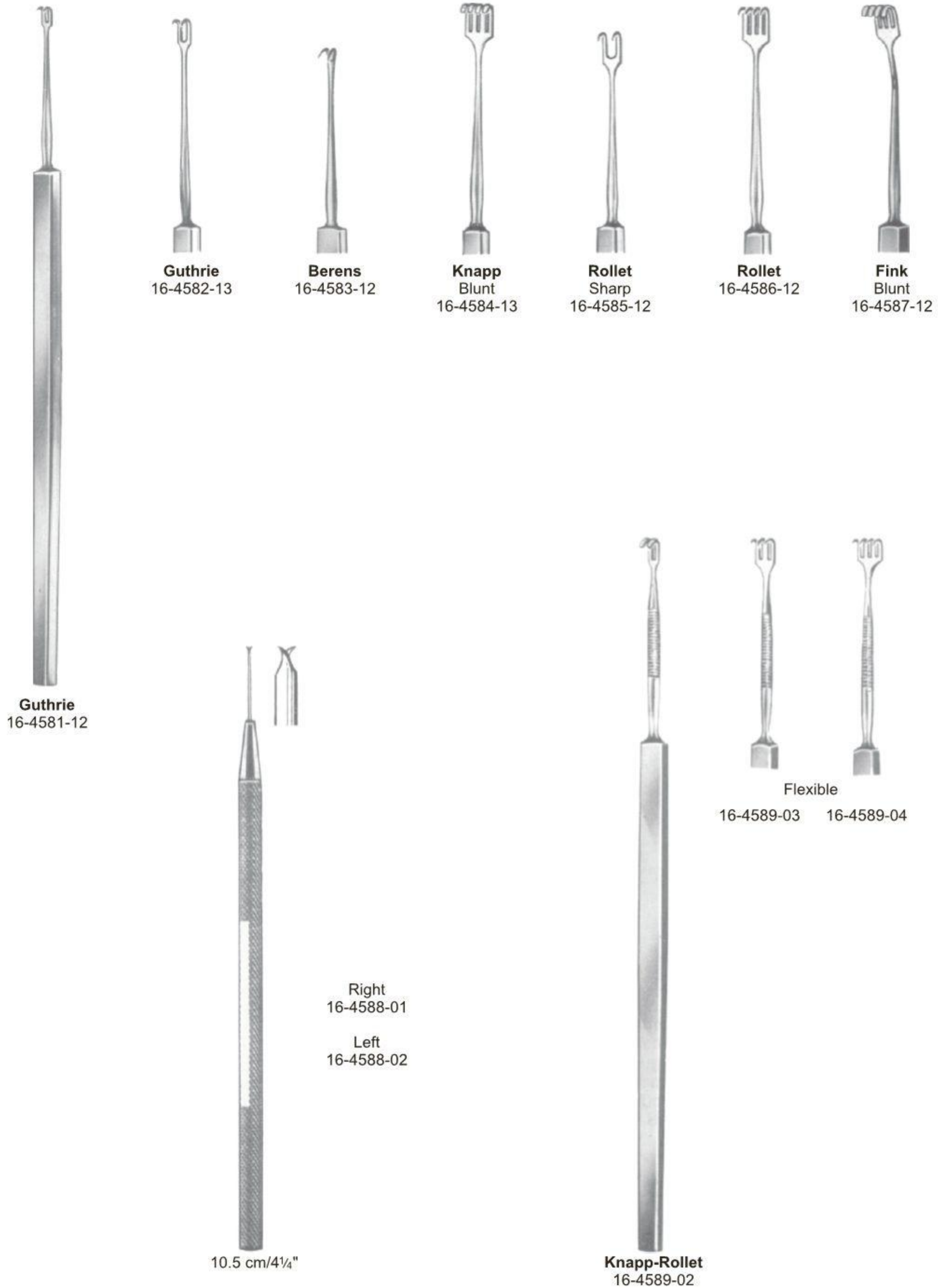



Axenfeld

Sharp
16-4590-14

Blunt
16-4591-14



Axenfeld

Sharp
16-4592-14

Blunt
16-4593-14



Paul
16-4594-12



Sautter
16-4595-01



Sautter
16-4596-02



Sautter
16-4597-03



Arruga
16-4598-13



Stevens
16-4599-14



Stevens
16-4600-12



Graefe
16-4601-01



Graefe
16-4602-02



Graefe
16-4603-03



Wecker
16-4604-13



Wecker
16-4605-13



Stock
16-4606-13



Stock
16-4607-13



Culler
16-4608-13



Suker
16-4609-14

- EN —● Enucleation Scoops and Chalazion Curettes
- DE —● Enucleation Schaufeln und Chalazion Küretten
- ES —● Enucleación Scoops y curetas Chalazión

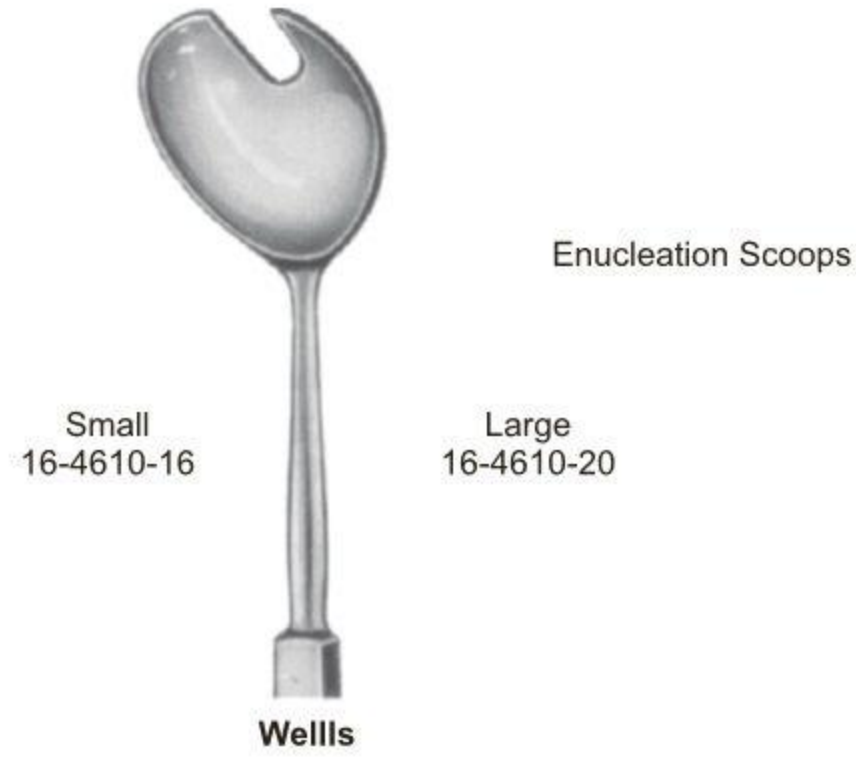

Chalazion Curettes



Exenteration Scoops and Chalazion Curettes Lachrymal Sac Dissectors ●— EN
 Exenteration Schaufeln und Chalazion Küretten Tränensack Dissektoren ●— DE
 Exenteración Scoops y Chalazión Curetas saco lagrimal Disectores ●— ES

Exenteration Scoops



Chalazion Curette, Double

Axenfeld
16-4614-13
13 cm/5"



Lachrymal Sac Dissector

Lang
16-4615-13
13 cm/5"

Irrigating Cannulas

Straight



Binkhorst
16-4616-01
22 gauge

Right



Binkhorst
16-4617-02
22 gauge

Left



Binkhorst
16-4618-03
22 gauge



Bonn
16-4619-04
20 gauge



Bonn
16-4620-05
19 gauge

Probe Point



Hamburg
16-4621-06
23 gauge

Irrigation/Aspiration Cannulas



Simcoe
16-4622-01
23 gauge



stotome Cannulas

Gills-Welsh
16-4623-02
25/23 gauge

Lens Manipulation Cannulas



Knolle-Kelmann
16-4624-01
22 gauge



Nevyas
16-4625-02
22 gauge



Kratz
16-4626-03
22 gauge



Freeman
16-4627-01
27 gauge



Irrigating Vectis Cannulas



Cortex Aspiration Cannulas

Capsule Polishing Cannulas



- EN —● Calipers, Markers, Punches Chisels, Marking instruments and Lachrymal Dilators
- DE —● Messschieber, Marker, Punches Meißel, Kennzeichnung Instrumente und Lachrymal Dilatoren
- ES —● Pinzas, marcadores, cinceles Punzones, los instrumentos de marcado y Dilatadores lagrimales



Castroviejo
16-4636-15



Castroviejo
16-4637-20
20 mm



Holth
16-4638-01



Haitz
16-4639-02



West
16-4640-16
16 cm/6 1/4"



West
16-4641-16
16 cm/6 1/4"



Connin-Amsler
16-4642-13
13 cm/5"



Wilder
16-4643-01



Wilder
16-4644-02



Wilder
16-4645-03

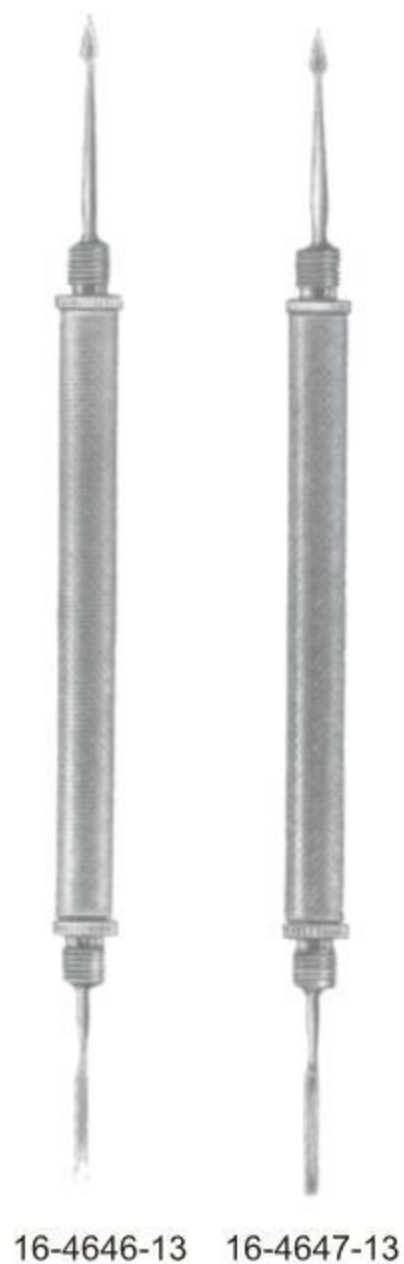

Needle Only
16-4648-01

Chisel Only
16-4648-02

Gouge Only
16-4648-03



Instrumentation for D. B. Kirby Operations



16-4651-10 1:2 Teeth
16-4652-10 2:3 Teeth





Tuebingen
16-4658-10
10 cm/4"



16-4659-08
8.5 cm/3 1/2"



Paufigue
16-4660-10
10 cm/4"



Barraquer
16-4661-10
10.5 cm/4 1/4"



McPherson
16-4662-10
10 cm/4"



McPherson
16-4663-07
7.5 cm/3"

Suture Forceps, Strabismus Forceps ●— EN
 Suture Pinzetten, Zangen Strabismus ●— DE
 Sutura Pinzas, estrabismo ●— ES



McCullough
16-4664-09
9.5 cm/3 3/4"



McCullough
16-4665-09
9.5 cm/3 3/4"



Bonaccoito
16-4666-10
10 cm/4"



Bonaccoito
16-4667-10
10 cm/4"



16-4668-11
11 cm/4 1/2"



11 cm/4 1/2"

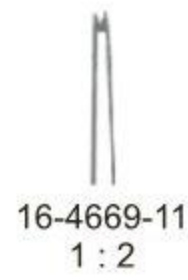

16-4669-11
1 : 2



16-4670-11
2 : 3



Nugent
10 cm/4"



16-4671-01



16-4672-02

EN —● Strabismus, Muscle and Advancement Forceps

DE —● Strabismus, Muskel-und Advancement Zange

ES —● Estrabismo, los músculos y Promoción Pinzas

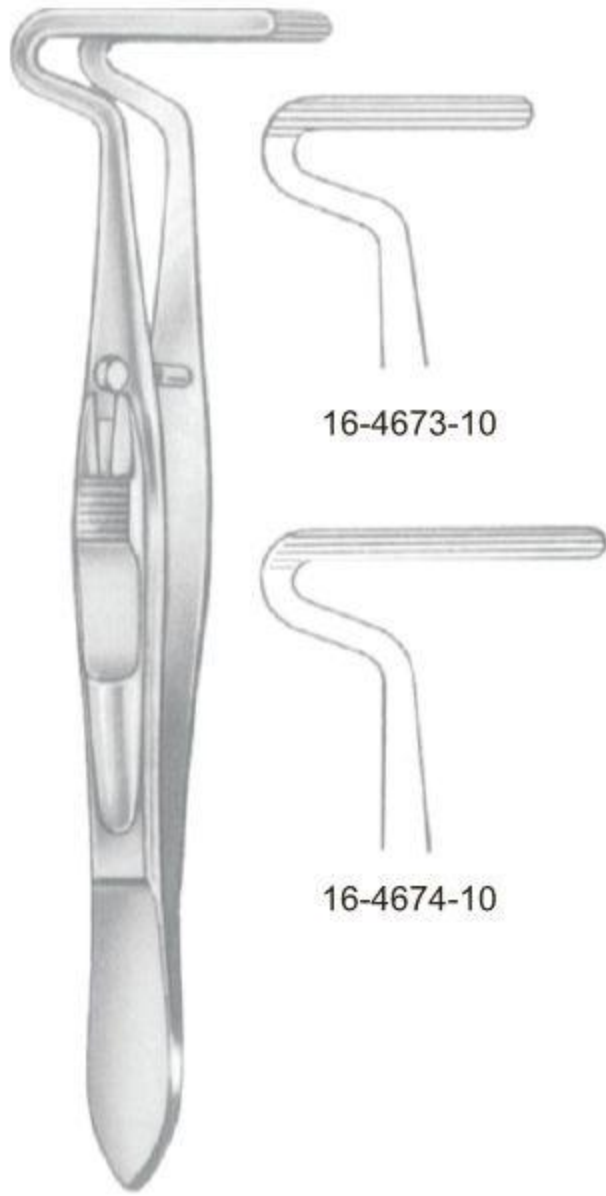

Berke
10 cm/4"



Blascovics
16-4675-09
9 cm/3 1/2"



Blascovics
16-4676-09
9 cm/3 1/2"



Worth
16-4677-10
10 cm/4"



Worth
16-4678-10
10 cm/4"



Jameson
16-4679-10
10 cm/4"



Jameson
16-4680-10
10 cm/4"



Prince
16-4681-10
10 cm/4"



Prince
16-4682-10
10 cm/4"

Entropium, Anterior Chamber Forceps ● EN
 Entropium, Vorderkammer Zange ● DE
 Entropion, pinzas Cámara Anterior ● ES



Snellen
 16-4683-10
 10 cm/4"



Snellen
 16-4684-10
 10 cm/4"



Erhardt
 16-4685-09
 9 cm/3 1/2"

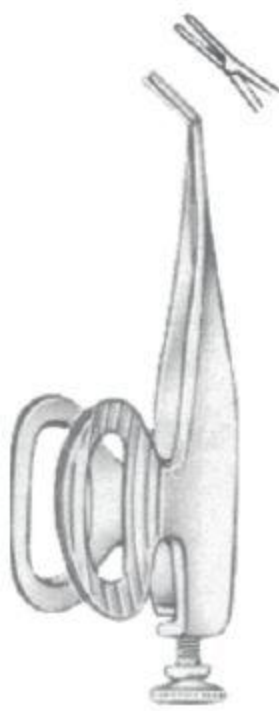

Barraquer
 16-4686-05
 5.5 cm/2 1/4"

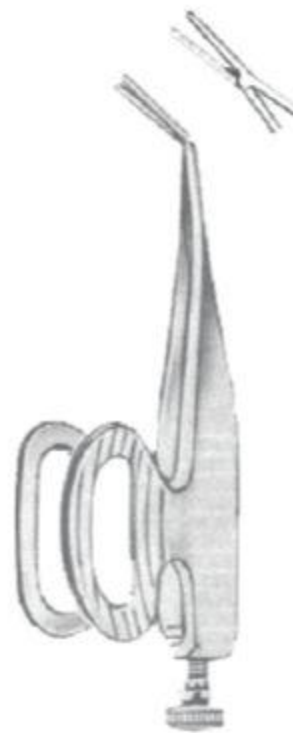

Barraquer
 16-4687-07
 5.5 cm/2 1/4"



Barraquer
 16-4688-10
 5.5 cm/2 1/4"



Iris Forceps ●— EN

Iris Zange ●— DE

Iris Pinzas ●— ES



Graefe
10 cm/4"



16-4696-10



16-4697-10



16-4698-10



16-4699-10



16-4700-10



16-4701-10

Conjunctival forceps



Stevens
10.5 cm/4¼"



16-4702-10



16-4703-10



16-4704-10



O'Connor
16-4708-10
10 cm/4"



16-4705-10



16-4706-10



16-4707-10



Stevens
16-4709-11
11 cm/4½"



Stevens
16-4710-11
11 cm/4½"



Fischer
16-4711-07
7 cm/2 3/4"



Fischer-Arit
16-4712-07
7 cm/2 3/4"



Hess
16-4713-07
7 cm/2 3/4"



Hess
16-4714-07
7 cm/2 3/4"



Smooth **Chandler** Serrated
16-4715-01 7 cm/2 3/4" 16-4716-02



Fuchs
16-4717-07
7 cm/2 3/4"



Gill-Hess
16-4718-07
7.5 cm/3"



Gill-Hess Teeth Below
16-4719-07 7.5 cm/3"
Teeth on side 16-4720-07



Barraquer-Katzin
(Colibri)
16-4721-07
7 cm/2 3/4"

Capsular Forceps ●— EN
 Kapsel-Pinzetten ●— DE
 capsular Pinzas ●— ES



Fuchs
 16-4722-07
 7 cm/2 ¾"



Kalt
 16-4723-10
 10 cm/4"



Terson
 16-4724-09
 9.5 cm/3 ¾"



Arruga-Nizetic
 16-4725-10
 10 cm/4"



Castroviejo
 16-4726-10
 10 cm/4"



Castroviejo
 16-4727-10
 10 cm/4"



Elschnig
 16-4728-10
 10 cm/4"

For Len Implantation



Binkhorst
 16-4729-07
 7 cm/2 ¾"



Arruga
 16-4730-09
 9.5 cm/3 ¾"



Arruga
 16-4731-09
 9.5 cm/3 ¾"



Knapp
16-4732-11
11 cm/4¼"



Ayer
16-4733-09
9 cm/3½"



Ayer
16-4734-09
9 cm/3½"



Lambert
16-4735-09
9 cm/3½"



Desmarres
16-4736-01
9 cm/3½"



16-4736-01



16-4737-02



16-4738-03



Fig. 1



Fig. 2



Fig. 3



Noyes
 Fig.1 16-4739-01
 Fig.2 16-4739-02
 Fig.3 16-4739-03
 12 cm/4 ¾"



Noyes
 16-4740-12
 12 cm/4 ¾"



Wecker
 11.5 cm/4 ½"



16-4741-01



16-4742-02



Barraquer
 16-4743-05
 5.5 cm/2 ¼"



16-4744-09
 9 cm/3 ½"



16-4745-09



16-4746-09



16-4747-09



16-4748-09



16-4749-09



Straight

Vannas
16-4750-08
8 cm/3 1/4"



Curved

Vannas
16-4751-08
8 cm/3 1/4"

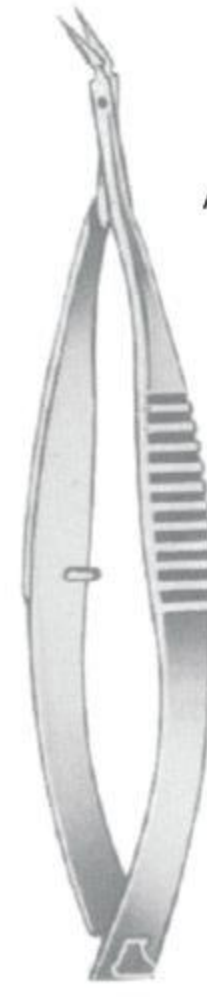

Angular

Vannas
16-4752-08
8 cm/3 1/4"

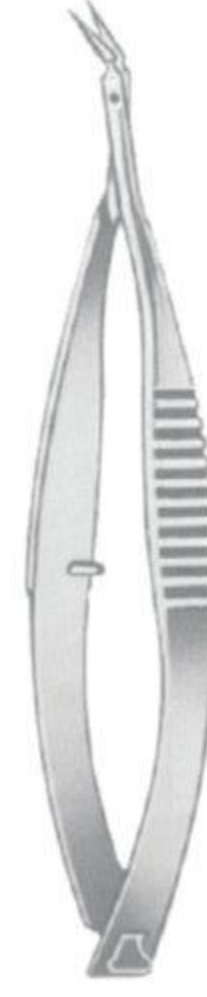

Vannas
16-4753-08
8 cm/3 1/4"



Straight

16-4754-08
8.5 cm/3 1/4"



Curved

16-4755-08
8.5 cm/3 1/4"

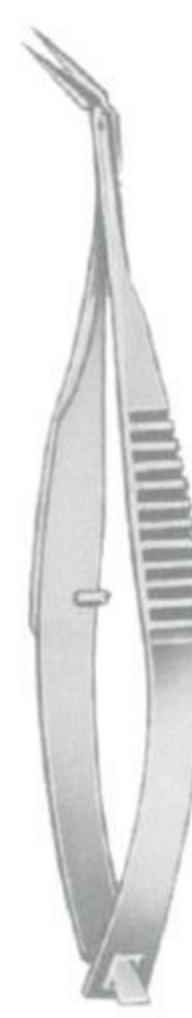

Angular

16-4756-08
8.5 cm/3 1/4"



Angular

16-4757-08
8.5 cm/3 1/4"

Vannas Mod, Tubingen

Iridectomy Scissors ●— EN
 Iridektomie Scissors ●— DE
 Tijeras iridectomía ●— ES



16-4758-10
 10 cm/4"



16-4759-10
 10 cm/4"



Castroviejo
 16-4760-10
 10 cm/4"



Castroviejo
 16-4761-10
 10 cm/4"



Aebli
 16-4762-10
 10 cm/4"

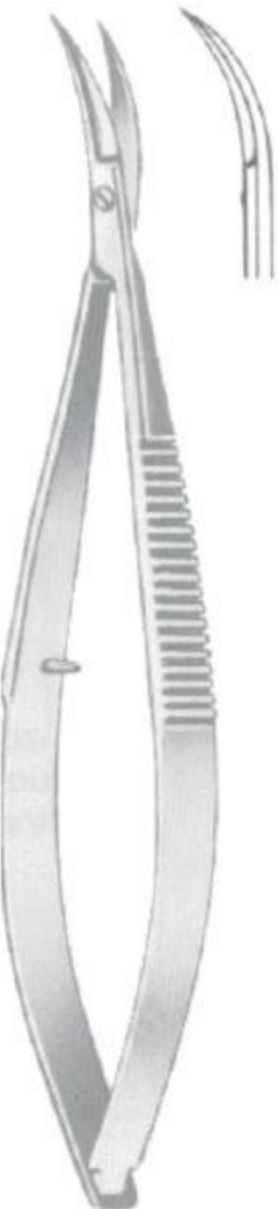

Castroviejo
 16-4763-10
 10 cm/4"

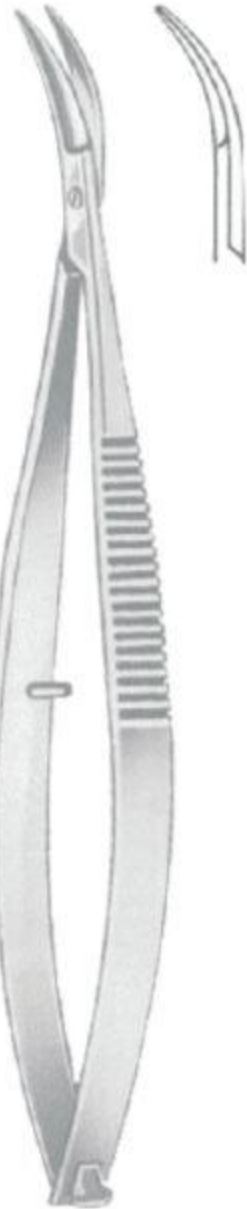

Castroviejo
 16-4764-10
 10 cm/4"

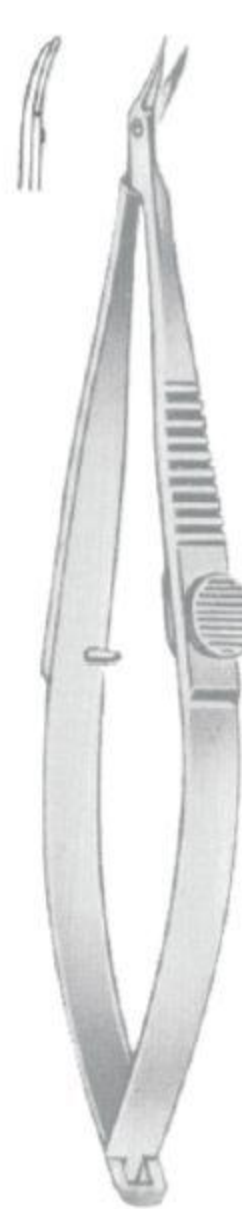

Troutman-Barraquer
 16-4765-10
 10 cm/4"



Troutman-Barraquer
 16-4766-10
 10 cm/4"



Saw Edge

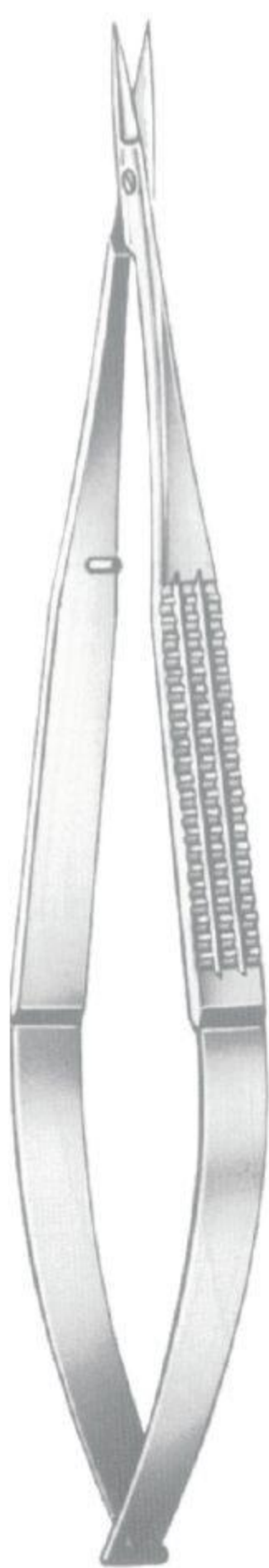

Straight
16-4767-16
16cm/6 1/4"

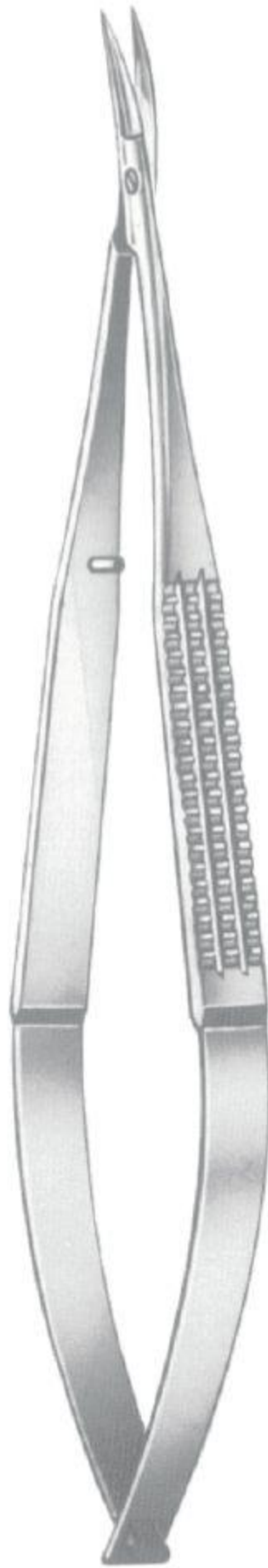

Curved
16-4768-16
16cm/6 1/4"



Straight
16-4769-16
16cm/6 1/4"

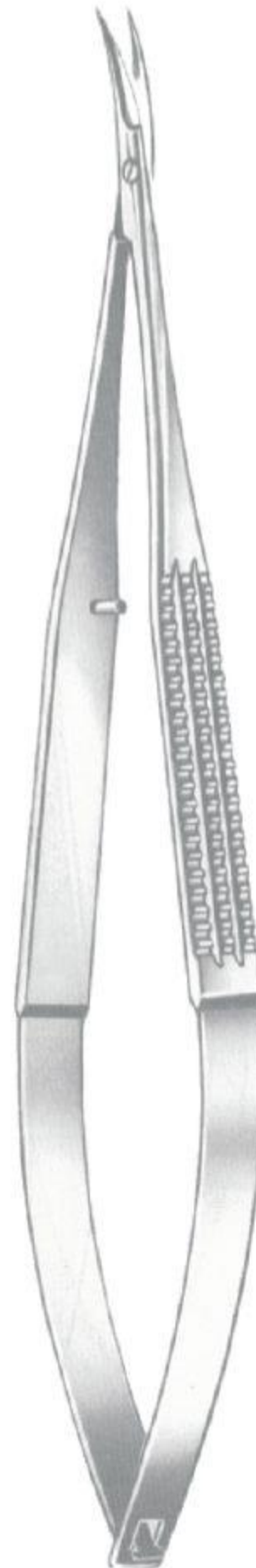

Curved
16-4770-16
16cm/6 1/4"



Millesi
Straight
16-4771-16
16cm/6 1/4"

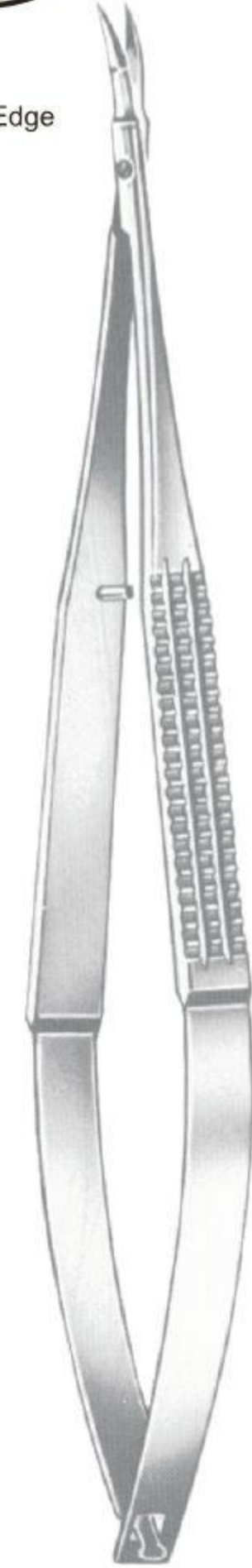

Millesi
Curved
16-4772-16
16cm/6 1/4"

Micro Scissors ● EN
 Mikro-Scheren ● DE
 Micro-Tijeras ● ES



Straight
 16-4773-18
 18.5cm/7 1/4"



Curved
 16-4774-18
 18.5cm/7 1/4"



Angular
 16-4775-18
 18.5cm/7 1/4"



Straight
 16-4776-23
 23cm/9"

Dissecting Scissors



Straight
16-4777-14
14.5cm/5 3/4"



Curved
16-4778-14
14.5cm/5 3/4"



Curved
16-4779-14
14.5cm/5 3/4"

EN Otology

DE Otologie

ES Otología

Page 420 to 437



Ø=Inside Dia



Troltsch
For Babies

- 17-4801-01 1.5 mm Ø
- 17-4801-02 2.5 mm Ø
- 17-4801-03 3.5 mm Ø

17-4801-30
Set of 3



Troltsch
For Adults

- 17-4802-04 4.0 mm Ø
- 17-4802-05 5.0 mm Ø
- 17-4802-06 6.0 mm Ø
- 17-4802-07 7.0 mm Ø

17-4802-30 17-4802-40
Set of 3 Set of 4



Politzer

- 17-4803-01 2.0 mm Ø
- 17-4803-02 3.0 mm Ø
- 17-4803-03 4.0 mm Ø

17-4803-30
Set of 3



Erhard
For Adults

- 17-4804-01 3.0 mm Ø
- 17-4804-02 4.0 mm Ø
- 17-4804-03 5.0 mm Ø
- 17-4804-04 6.0 mm Ø

17-4804-30 17-4804-40
Set of 3 Set of 4



Hartmann
For Babies

- 17-4805-01 2.0 mm Ø

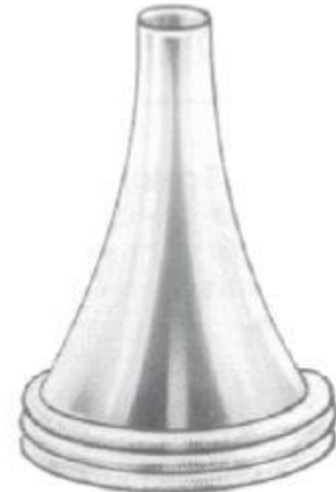

Hartmann
For Children

- 17-4806-02 3.0 mm Ø
- 17-4806-03 4.0 mm Ø
- 17-4806-04 5.5 mm Ø

17-4806-30
Set of 3



Hartmann
For Adults

- 17-4807-03 4.0 mm Ø
- 17-4807-04 5.5 mm Ø
- 17-4807-05 6.5 mm Ø
- 17-4807-06 7.5 mm Ø

17-4807-30 17-4807-40
Set of 3 Set of 4



Toynbee
For Adults

- 17-4808-01 4.5 mm Ø
- 17-4808-02 5.5 mm Ø
- 17-4808-03 6.5 mm Ø
- 17-4808-04 7.5 mm Ø

17-4808-30 17-4808-40
Set of 3 Set of 4

Alu Black



17-4809-60
Set of 6

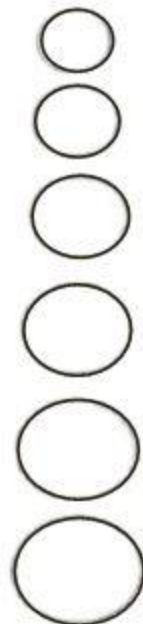

Ø=Inside Dia

- 17-4809-01 4.5 x 5.5 mm Ø
- 17-4809-02 5.5 x 6.5 mm Ø
- 17-4809-03 6.5 x 7.5 mm Ø
- 17-4809-04 7.5 x 8.5 mm Ø
- 17-4809-05 8.5 x 9.5 mm Ø
- 17-4809-06 9.5 x 10.5 mm Ø



Gruber

17-4810-30 17-4810-40 17-4811-40 17-4811-40
Set of 3 Set of 4 Set of 3 Set of 4



- 17-4810-01 3 mm Ø
- 17-4810-02 4 mm Ø
- 17-4810-03 5 mm Ø
- 17-4810-04 6 mm Ø



- 17-4811-01 3 mm Ø
- 17-4811-02 4 mm Ø
- 17-4811-03 5 mm Ø
- 17-4811-04 6 mm Ø

Ear Speculas ●— EN
 Ohrspekula ●— DE
 Espéculos auriculares ●— ES



Hartmann
 17-4812-40
 Set of 4

- Black
- 17-4812-01 3.0 mm Ø
 - 17-4812-02 4.0 mm Ø
 - 17-4812-03 5.0 mm Ø
 - 17-4812-04 7.0 mm Ø



Hartmann
 17-4813-20
 Set of 2

- Black
- 17-4813-05 9.0 mm Ø
 - 17-4813-06 11.0 mm Ø



17-4814-01



17-4814-02
 17-4814-01 4.2 x 3.8 mm
 17-4814-02 5.5 x 3.8 mm
 17-4814-03 6.5 x 3.8 mm
 17-4814-30
 Set of 3



17-4814-03



17-4815-01



17-4815-02



17-4815-03

- 17-4815-01 4.2 mm
- 17-4815-02 5.5 mm
- 17-4815-03 6.5 mm
- 17-4815-30
 Set of 3

- 17-4816-03 3.5 mm Ø
- 17-4816-04 4.5 mm Ø
- 17-4816-05 5.5 mm Ø
- 17-4816-06 6.5 mm Ø

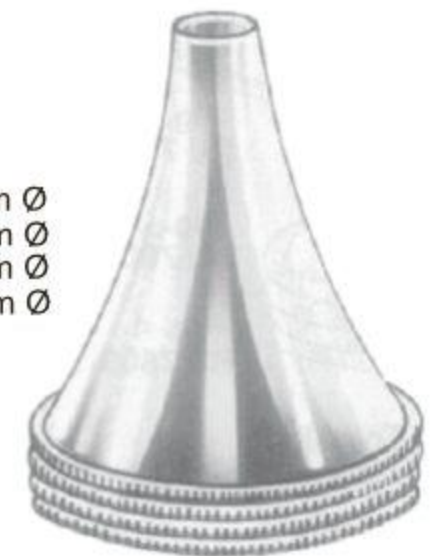

Boucheron
 17-4816-40
 Set of 4



Turmakin Speculum
 Black finish (slot)

A= Distal tip diameter
 B= Distal slot width
 C= Proximal slot width

- 17-4817-01 No. 1 A=3mm B=2.5mm C=4mm
- 17-4817-02 No. 2 A=4.5mm B=3mm C=5mm
- 17-4817-03 No. 3 A=6.5mm B=3mm C=5mm
- 17-4817-04 No. 4 A=7mm B=3mm C=5mm
- 17-4817-05 No. 5 A=7.5mm B=3.5mm C=7mm
- 17-4817-06 No. 6 A=8mm B=4mm C=8mm
- 17-4817-07 No. 7 A=8.5mm B=4.5mm C=9mm
- 17-4817-08 No. 8 A=9mm B=5mm C=10mm
- 17-4817-09 No. 9 A=11mm B=6mm C=11mm



Gruber Speculum
 Black finish (round)

- 17-4818-03 3mm
- 17-4818-04 4mm
- 17-4818-05 5mm
- 17-4818-06 6mm

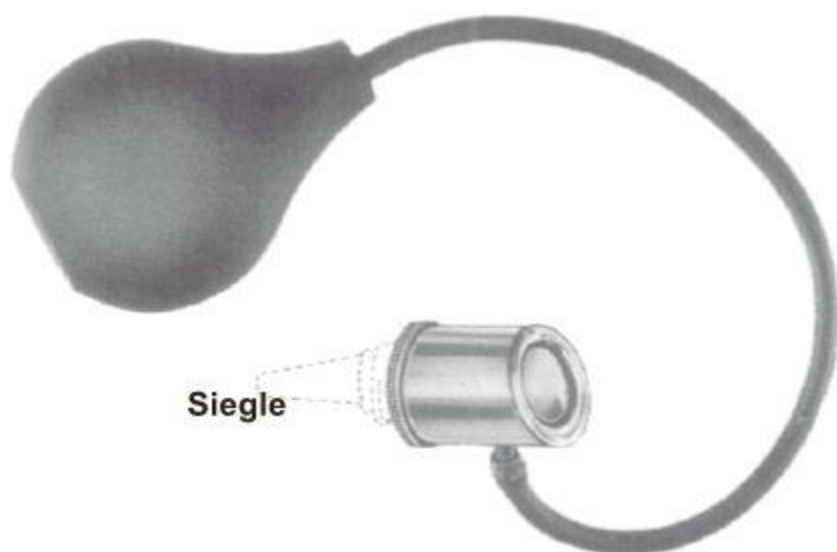

Siegle



Otoscope with 3 ear specula and rubber tube with bulb
 17-4819-00

Tuning Forks



Hartmann

Lucae

**French
Hartmann**

**Lucae
C 128**

**Hartmann
C 128**

**Rydel-Seiffer
17-4825-00
C 64/C 128**

16			17-4822-16
32			17-4822-32
64			17-4822-01
128	17-4820-00	17-4821-00	17-4822-02
256	17-4820-01	17-4821-01	17-4822-03
512	17-4820-02	17-4821-02	
1024	17-4820-03	17-4821-03	
2048	17-4820-04	17-4821-04	
4096	17-4820-05	17-4821-05	

Variable up to h (Engl. B)
17-4823-00 17-4824-00

With Clamps = C 64
Without Clamps = C 128



Tuning Fork for neurological examination, with percussion hammer, pin wheel, brush and needle
17-4826-00



17-4827-01
C 64

17-4827-02
C 128

17-4827-03
C 256

17-4827-04
C 512

17-4827-05
C 1024

17-4827-06
C 2048

17-4827-07
C 4096

Tuning Forks, Eustachin Catheters and Suction Instruments — EN

Tuning Forks, Eustachin Katheter und Sauginstrumente — DE

Diapasones, catéteres e instrumentos de succión Eustachin — ES

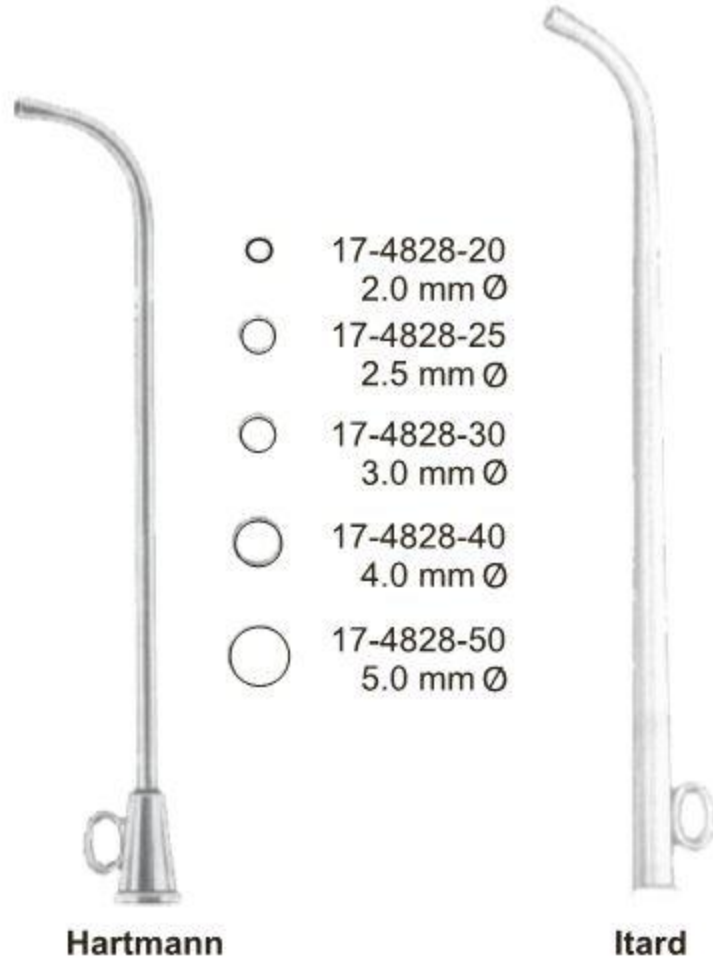

- 17-4828-20
2.0 mm Ø
- 17-4828-25
2.5 mm Ø
- 17-4828-30
3.0 mm Ø
- 17-4828-40
4.0 mm Ø
- 17-4828-50
5.0 mm Ø

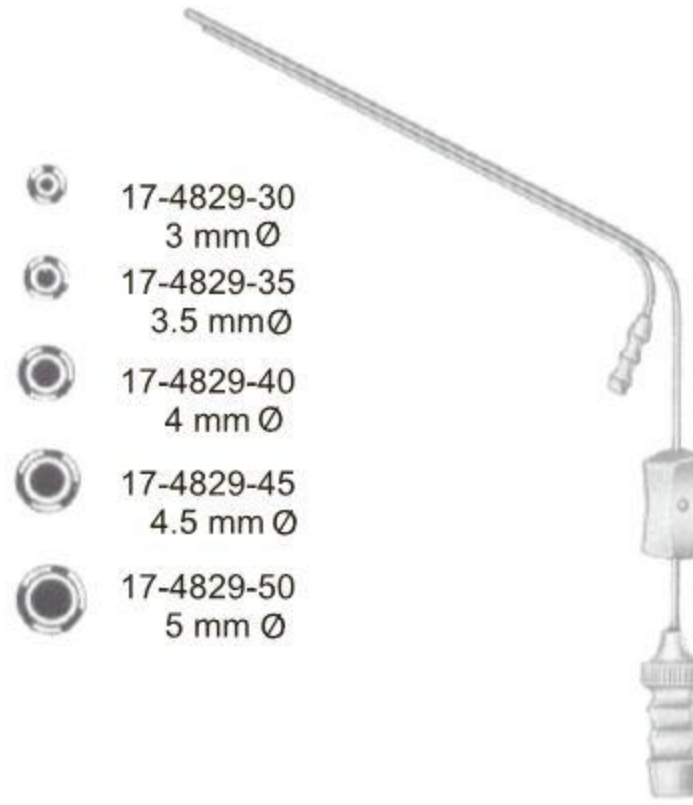

- House**
- 17-4830-09 0.9 mm Ø
 - 17-4830-12 1.2 mm Ø
 - 17-4830-15 1.5 mm Ø



- Baron (Schuknecht)**
- 17-4831-01 1.0 x 75 mm
 - 17-4831-02 1.5 x 75 mm
 - 17-4831-03 2.0 x 75 mm

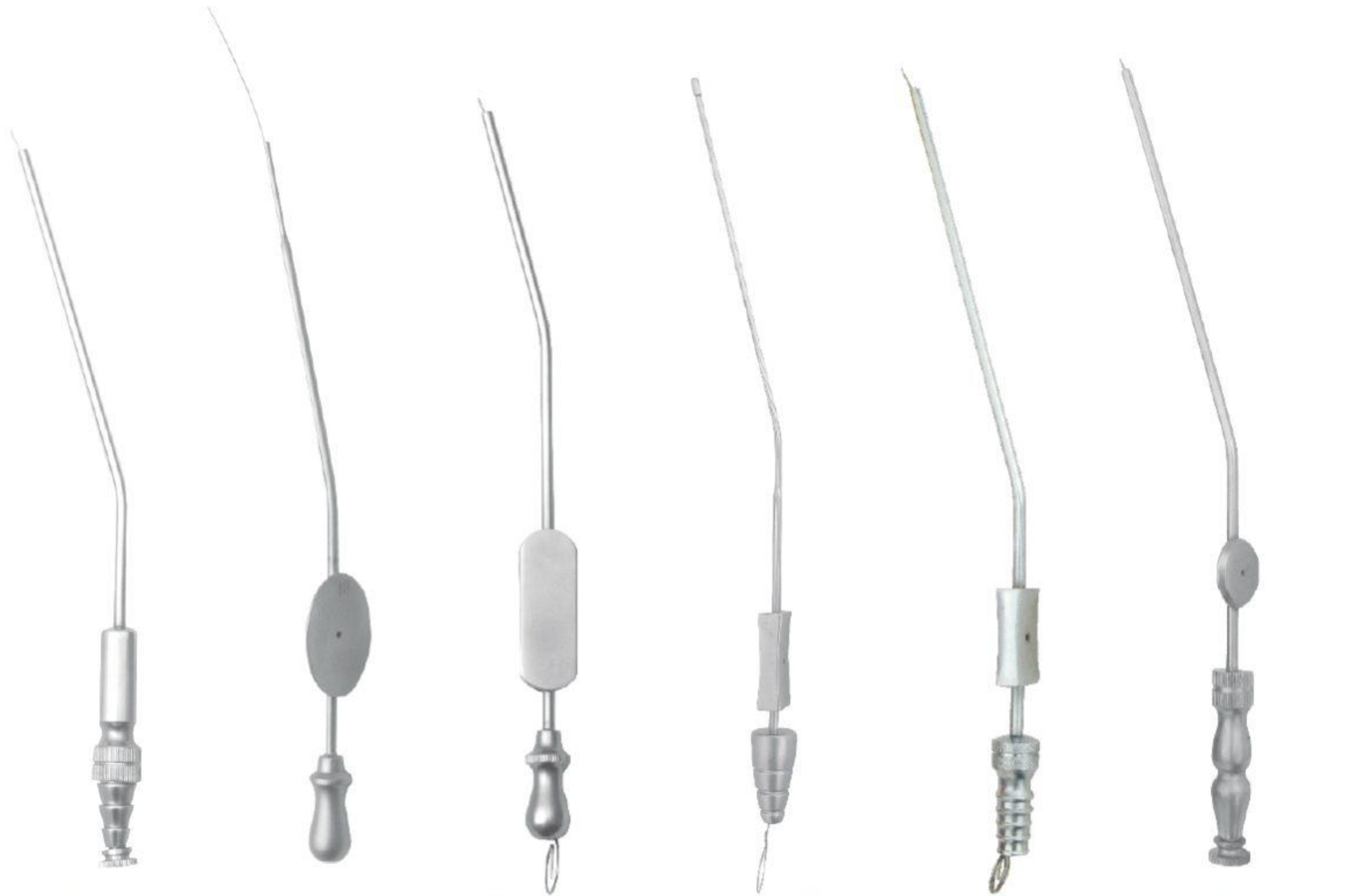

Adson Frazier Suction Tube
with stilette
17-4832-02
2 x 180 mm
17-4832-03
3 x 180 mm

Schucknecht Suction Tube
with stilette
17-4833-18 swg 18
17-4833-20 swg 20
17-4833-22 swg 22
17-4833-24 swg 24

Zoellner Suction Tube
with stilette
length 150 mm
17-4834-15

Firth Suction Tube
rounded tip, with stilette
17-4835-70
70 x 80 mm
17-4835-80
80 x 90 mm

Lempert Suction Tube
with stilette
17-4836-06
Fig. 6, 2mm
17-4836-09
Fig. 9, 3mm
length 200 mm

Fraizer Suction Tube
with stilette
17-4837-02
Dia 2 mm
17-4837-03
Dia 3 mm
length 200 mm

- EN —● Ear Polypus Snares and Ear Dressing Forceps
- DE —● Polypenschnürer, Ohrpinzetten
- ES —● Polipótomos, Pinzas auriculares



Krause
17-4838-16
16 cm/6 1/4"



Krause-Voss
17-4839-16
16 cm/6 1/4"



Lange-Wilde
17-4840-16
16 cm/6 1/4"



Package of 1 dozen each

mm Ø	
17-4841-02	0.2
17-4841-03	0.3

Ear Dressing Forceps



**Troeltsch
(Wilde)**



Troeltsch



Lucae



Lucae



Jansen

Cm	In				
11.0	4 1/4"	17-4842-11			
12.0	4 3/4"	17-4842-12	17-4843-12		17-4845-14
14.0	5 1/2"	17-4842-14		17-4844-14	
15.0	6"	17-4842-15			
16.0	6 1/4"				17-4846-16
18.0	7"				17-4846-18
20.0	8"				17-4846-20

Ear Polypus Forceps and Foreign Body Levers ●— EN
 Polypenzängchen, Fremdkörperheber ●— DE
 Pinzas para pólipos, Elevadores para cuerpos extraños ●— ES



Okonogto
 17-4847-16
 16 cm/6¼"



Littauer
 17-4848-12
 12 cm/4¾"



Fine Pattern

Hartmann
 17-4849-12
 12 cm/4¾"



Hartmann
 17-4850-14
 14 cm/5½"



Standard Pattern

Tilley Aural Forcep
 17-4851-14 14cm/5 ½"
 17-4851-16 16cm/6 ¼"
 17-4851-18 18cm/7"



Buck
 17-4852-09
 9 cm/3½"



Quire
 17-4853-08
 8 cm/3¼"



Hartmann-Noyes
17-4854-09
8.5 cm/3 1/4"



1 : 2



Hartmann-Noyes
17-4855-09
8.5 cm/3 1/4"



Hartmann
17-4856-09 8.5 cm/3 1/4"
17-4856-14 14 cm/5 1/2"
17-4856-16 16 cm/6 1/4"



1 : 2



Hartmann
17-4857-09 8.5 cm/3 1/4"
17-4857-14 14.0 cm/5 1/2"



Hartmann
17-4858-20 8.5 cm/3 1/4" ○ 2.0 mm
17-4858-25 8.5 cm/3 1/4" ○ 2.5 mm
17-4858-30 8.5 cm/3 1/4" ○ 3.0 mm



Hartmann-Citelli
17-4859-02 ○ 2 mm 8.5 cm/3 1/4"
17-4859-03 ○ 3 mm 8.5 cm/3 1/4"



Strumpel
17-4860-09
8.5 cm/3 1/4"



Hartamm-Weingartner
17-4861-09
8.5 cm/3 1/4"



Hartamm
17-4862-09
8.5 cm/3 1/4"



Hartamm-Wullstein
17-4863-06 8.5 cm/3 1/4" 08 x 6 mm
17-4863-08 8.5 cm/3 1/4" 1.8 x 8 mm



Hartamm-Wullstein
17-4864-01 ○ 1 mm 8.5 cm/3 1/4"
17-4864-02 ○ 2 mm 8.5 cm/3 1/4"



	Micro Forceps	Mini	Cup-Shaped Forceps
	1.6 x 7.0 mm 17-4865-01	0.7 x 3.5 mm 17-4866-08	0.9 x 1.1 mm 17-4867-11
	 17-4868-02 0.8 x 4.0 mm		
Smooth Jaw	 17-4869-03 0.8 x 6.0 mm		
Curved Left	 17-4870-04 0.8 x 6.0 mm		 17-4871-12 0.9 x 1.1 mm
Curved Right	 17-4872-05 0.8 x 4.0 mm		 17-4873-13 0.9 x 1.1 mm
Angled Up	 17-4874-06 0.8 x 4.0 mm		 17-4875-14 0.9 x 1.1 mm
Angled Down	 17-4876-07 0.8 x 4.0 mm		 17-4877-15 0.9 x 1.1 mm



Curved Right 17-4878-01
Curved Left 17-4878-02
Angled Up 17-4878-03
Angled Down 17-4878-04



Cup-Shaped Forceps

Micro Forceps 0.5 mm

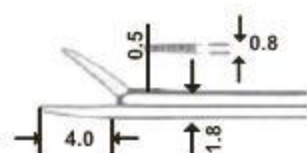

Straight 17-4879-01

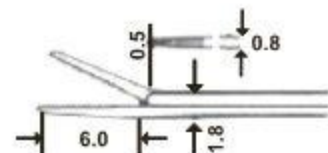

17-4879-02

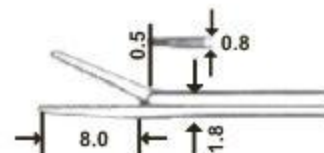

17-4879-03

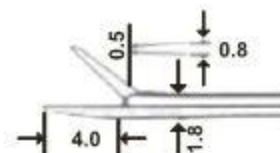

17-4879-04

Smooth Jaw

1.5 x 0.8 mm

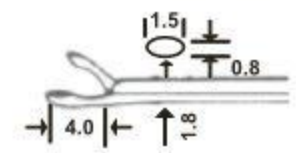

Straight 17-4883-01
Curved Right 17-4883-02
Curved Left 17-4883-03
Angled Up 17-4883-04
Angled Down 17-4883-05

Micro Forceps 0.3 mm

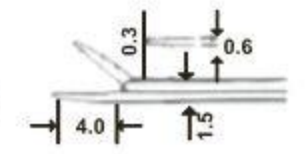

Straight 17-4880-01

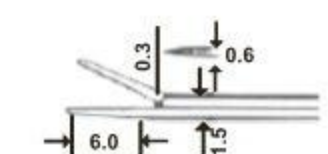

17-4881-02

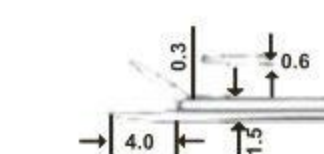

17-4882-03

Smooth Jaw

1.0 x 0.5 mm

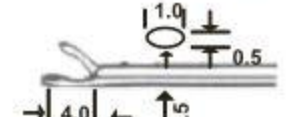

Straight 17-4883-06

Length of Shaft 8 cm

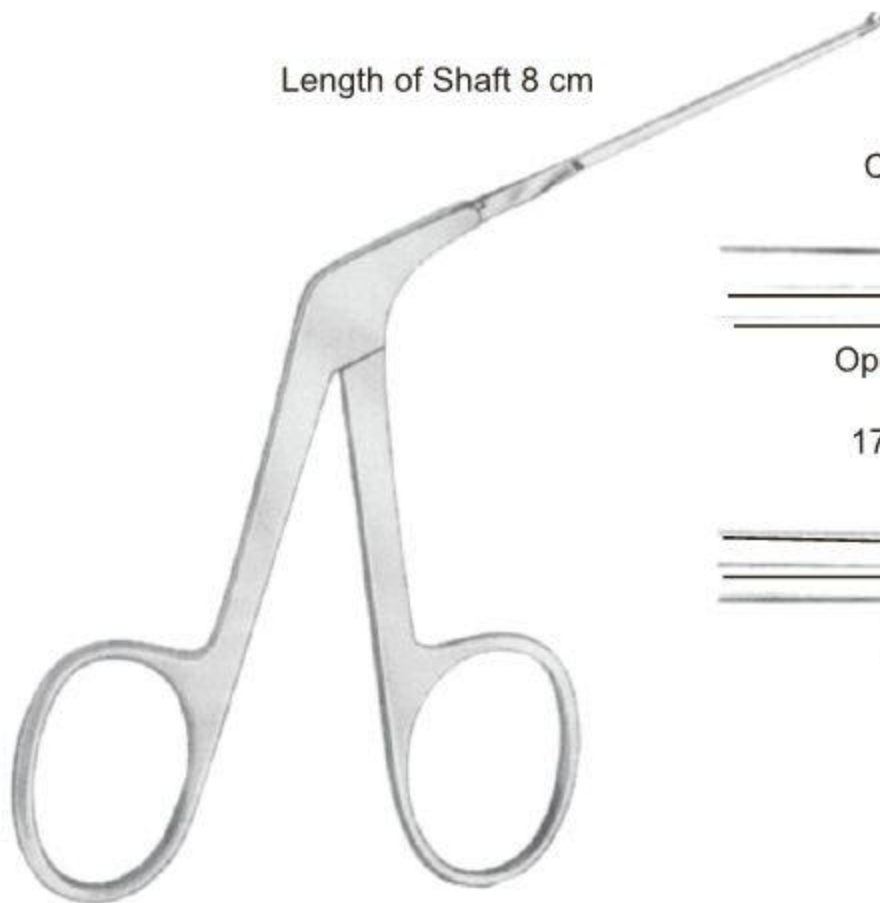

Crura Forceps



Open to Right
Fisch
17-4885-01



Open to Left
Fisch
17-4885-02

Micro Scissors

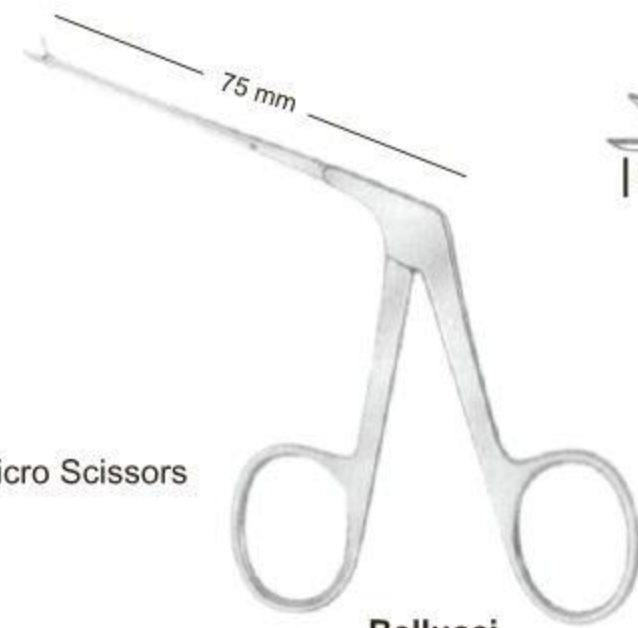

Bellucci
0.8 mm

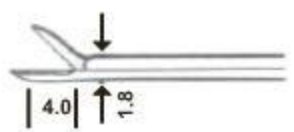

17-4884-01
17-4884-02
17-4884-03
17-4884-04
17-4884-05

Length of Shaft 8 cm



Wire Closure Forceps

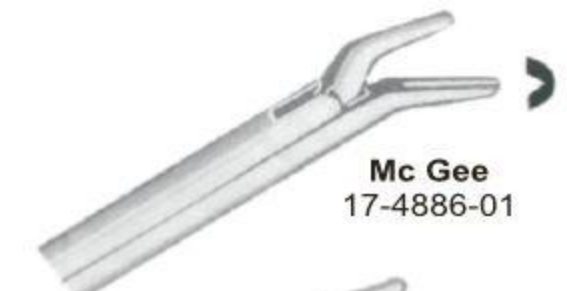

Mc Gee
17-4886-01



Mc Gee/Fisch
17-4886-02



Henckel
 crocodile, scoop blades
 17-4887-02



Cawthorne
 micro crocodile scissor, 5 mm blade
 17-4888-01 Straight
 17-4888-02 Curved
 17-4888-03 Angled



Hartmann
 micro crocodile, 3 mm serrated jaws
 17-4890-02

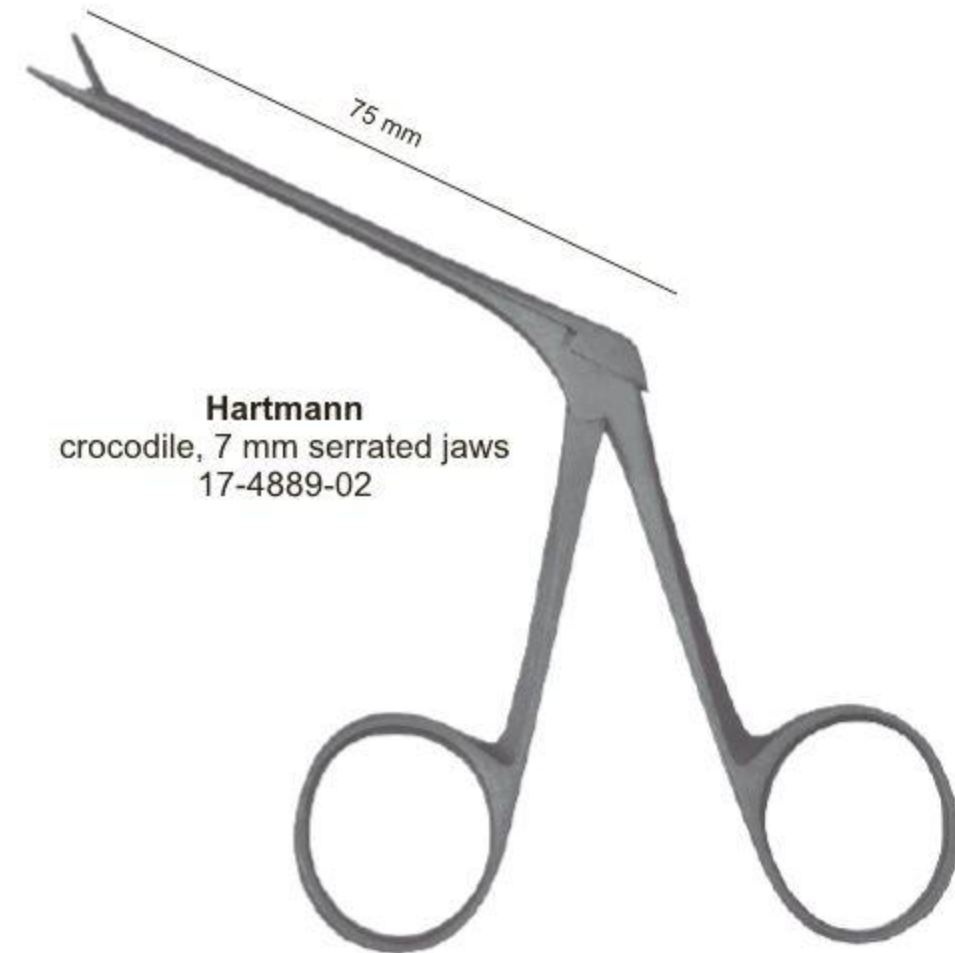

Hartmann
 crocodile, 7 mm serrated jaws
 17-4889-02

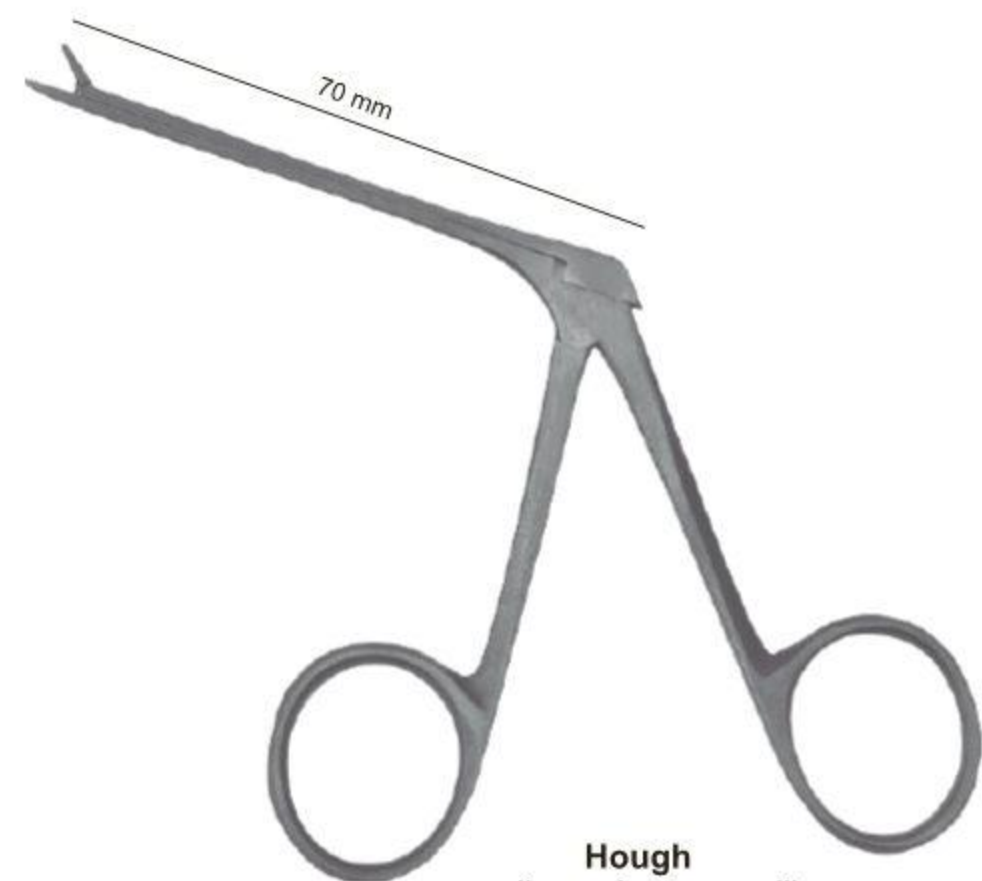

Hough
 medium micro crocodile
 5 mm serrated jaws
 17-4891-01 Straight
 17-4891-02 Angled

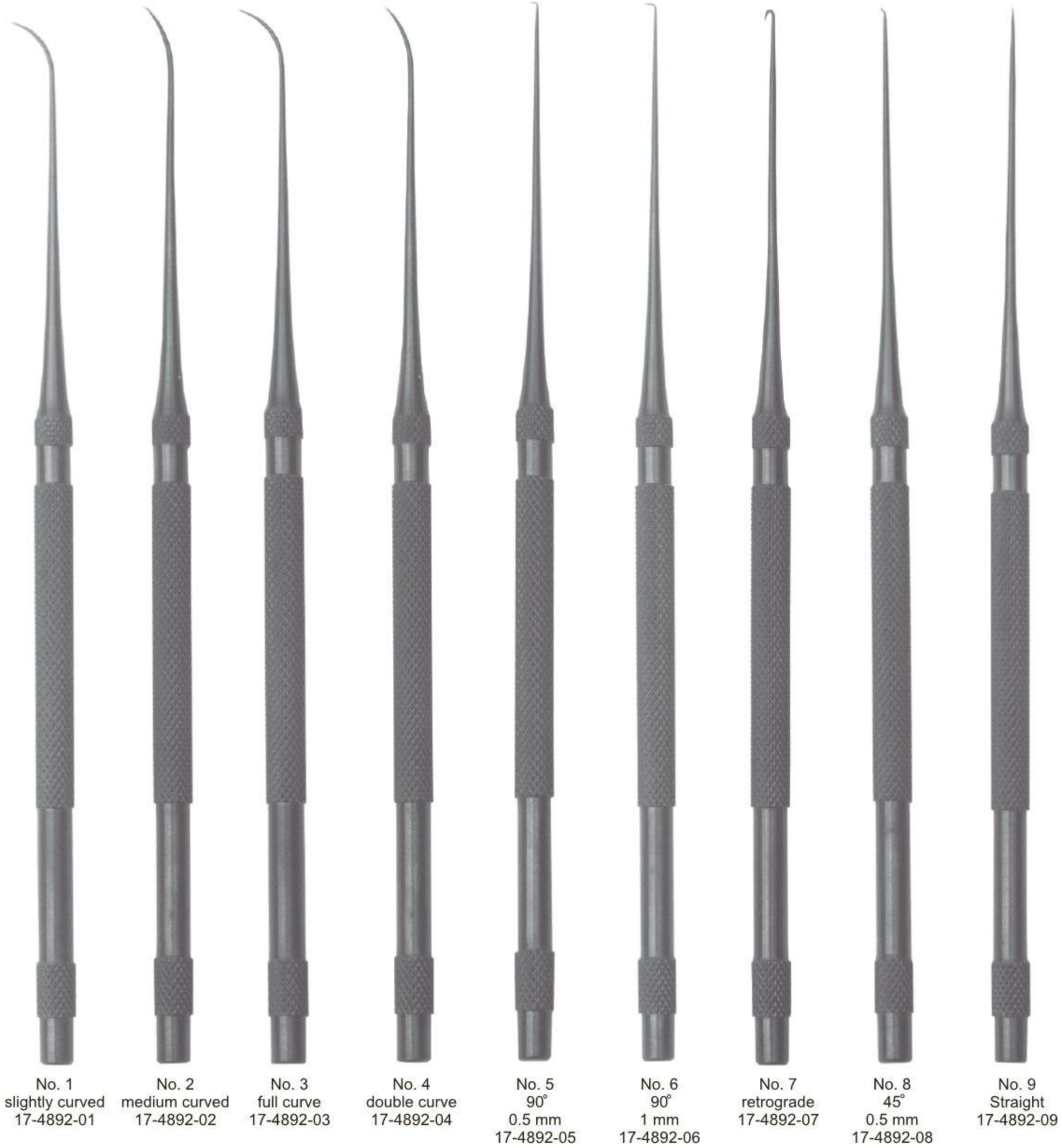

Cawthorne Stape Hook (Black Finish)
16.5cm / 6 1/2"
17-4892-10 (set of 9)

Messer



Schuknecht
17-4893-01

Schuknecht
17-4894-02

Schuknecht
17-4895-01

Knives



Wullstein
17-4896-01



Tabb
17-4897-01



Plester
17-4898-01

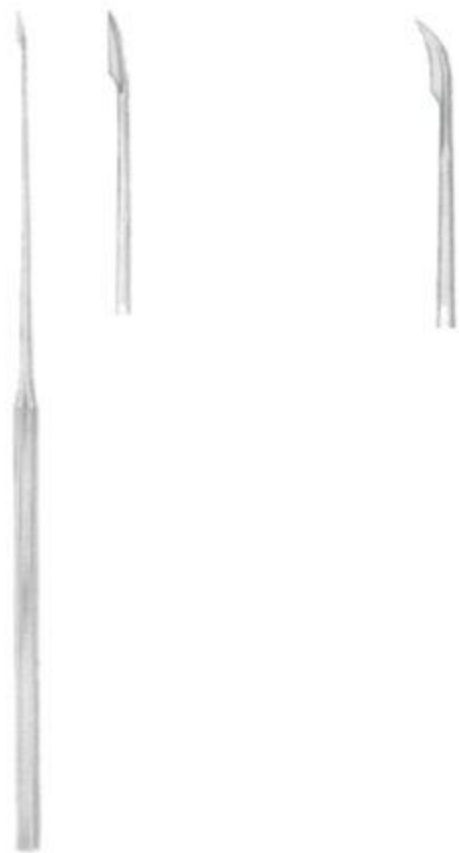

Plester
17-4899-02

17-4900-03



Rosen

17-4904-20
2.0 mm



17-4901-10
1.0 mm



17-4902-14
1.4 mm



17-4903-16
1.6 mm



17-4905-26
2.6 mm



17-4906-28
2.8 mm



17-4907-30
3.0 mm

Needles And Hooks

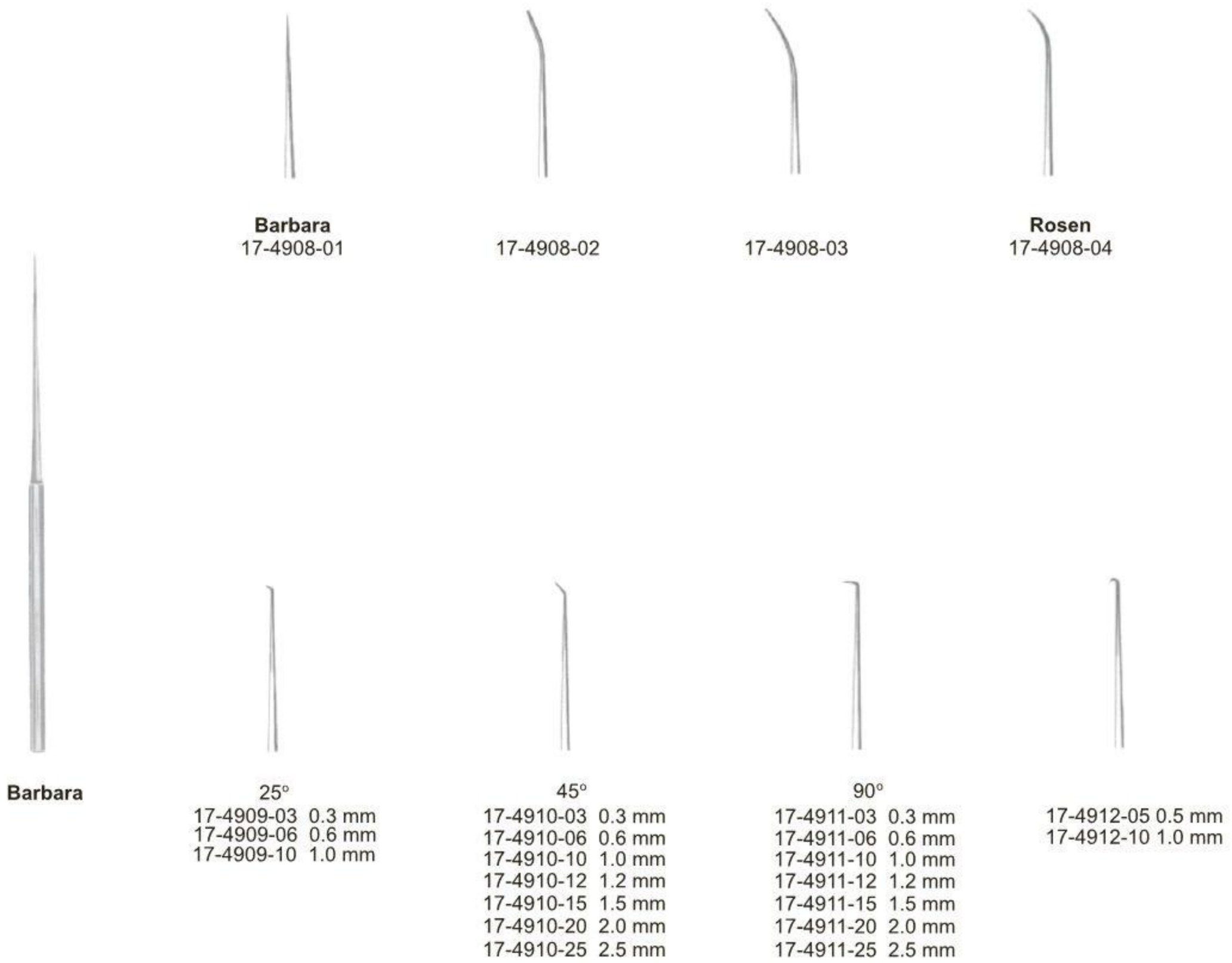

Barbara
17-4908-01

17-4908-02

17-4908-03

Rosen
17-4908-04

Barbara

25°
17-4909-03 0.3 mm
17-4909-06 0.6 mm
17-4909-10 1.0 mm

45°
17-4910-03 0.3 mm
17-4910-06 0.6 mm
17-4910-10 1.0 mm
17-4910-12 1.2 mm
17-4910-15 1.5 mm
17-4910-20 2.0 mm
17-4910-25 2.5 mm

90°
17-4911-03 0.3 mm
17-4911-06 0.6 mm
17-4911-10 1.0 mm
17-4911-12 1.2 mm
17-4911-15 1.5 mm
17-4911-20 2.0 mm
17-4911-25 2.5 mm

17-4912-05 0.5 mm
17-4912-10 1.0 mm

Needles And Hooks



90°
 17-4913-03 0.3 mm
 17-4913-06 0.6 mm
 17-4913-10 1.0 mm

90°
 17-4914-03 0.3 mm
 17-4914-06 0.6 mm
 17-4914-10 1.0 mm

McGee
 17-4915-05 0.5 mm
 17-4915-10 1.0 mm

McGee
 17-4916-05 0.5 mm
 17-4916-10 1.0 mm



Barbara
 17-4917-01

Rosen
 17-4917-02

25°
 17-4918-03 0.3 mm
 17-4918-06 0.6 mm
 17-4918-10 1.0 mm

25°
 17-4919-03 0.3 mm
 17-4919-06 0.6 mm
 17-4919-10 1.0 mm

45°
 17-4920-03 0.3 mm
 17-4920-06 0.6 mm
 17-4920-10 1.0 mm

45°
 17-4921-03 0.3 mm
 17-4921-06 0.6 mm
 17-4921-10 1.0 mm

Dissectors, Measuring Road, Elevators, Currettes and Mobilizer



Fisch



17-4922-01



17-4922-02



17-4922-03



17-4922-04



Rosen

17-4923-15 1.5 mm 17-4923-25 2.5 mm



Rosen



17-4924-01



17-4924-02



17-4924-03



17-4924-04



17-4924-05



17-4924-06



House



17-4925-01
3.5 mm



17-4925-02
4.0 mm



17-4925-03
4.5 mm



17-4925-04
5.0 mm



Buckingham



17-4926-01



17-4926-02



17-4926-03



St. Bart Blunt Hook
 17-4927-18
 18 cm / 7"



House
 17-4928-10 1.0/1.2 mm
 17-4928-15 1.5/1.8 mm



House
 17-4929-10 1.0/1.2 mm
 17-4929-15 1.5/1.8 mm



Shea
 17-4930-15 1.5 mm



Negus Aspiration
 17-4931-18
 21 cm / 8 1/4"



Jobson Horne Probe
 one side serrated
 one side ring
 17-4932-17
 17.5 cm / 7"



Zollner

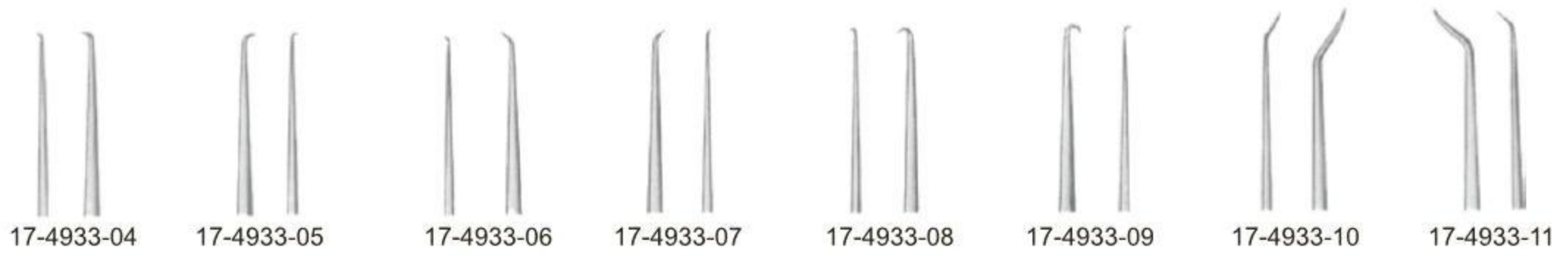



Width of Bite

Citelli
 17-4934-20 2.0 mm
 17-4934-30 3.0 mm



Width of Bite





Citelli-Beyer
 17-4935-15 1.5 mm
 17-4935-20 2.0 mm



Width of Bite



Brunings
 17-4936-40
 17-4936-60

-  17-4937-30 3.0 mm
-  17-4937-40 4.0 mm
-  17-4937-50 5.0 mm
-  17-4937-60 6.0 mm



Kerrison
 20 cm/8"

EN Rhinology

DE Rhinologie

ES Rinología

Page 438 to 462





Fraenkel
18-5001-01 Fig. 1
18-5001-02 Fig. 2
18-5001-03 Fig. 3



18-5002-01
18-5002-02
18-5002-03
13 cm/5"



Fig. 1
18-5003-01
18-5003-01

Fig. 2
18-5004-02
18-5004-02

Fig. 3
18-5005-03
18-5005-03



18-5006-01
18-5006-02
18-5006-03
13 cm/5"



Hartmann
15 cm/6"

18-5007-01

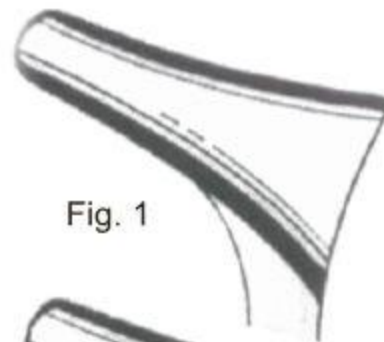

Fig. 1

18-5008-01

18-5007-02

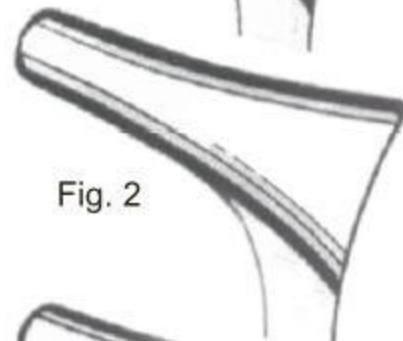

Fig. 2

18-5008-02

18-5007-03

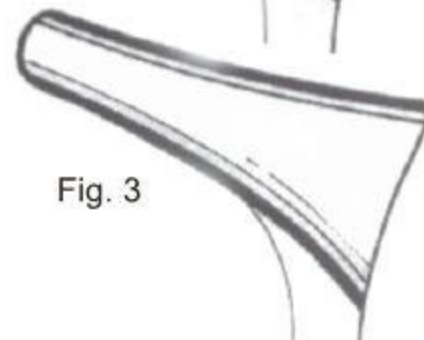

Fig. 3

18-5008-03



Hartmann
15 cm/6"



18-5009-01

18-5009-02

18-5009-03

Hartmann-Halle
 15 cm/6"

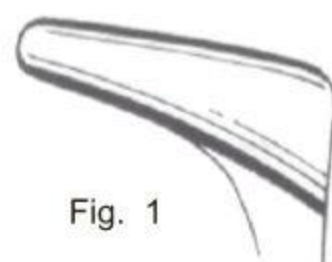

Fig. 1

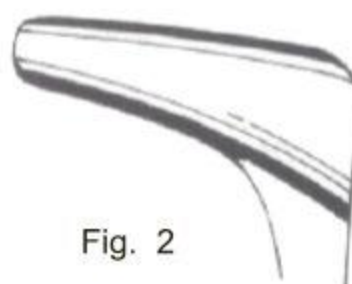

Fig. 2

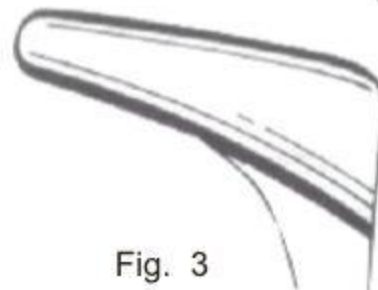

Fig. 3



18-5010-01

18-5010-02

18-5010-03

Hartmann-Halle
 15 cm/6"



18-5011-01

18-5011-02

Tieck
 13.5 cm/5 1/4"



18-5012-01

18-5012-02



Tieck
 13.5 cm/5 1/4"



Beckmann
 15 cm/6"



Fig. 1
 18-5013-01



Fig. 2
 18-5013-02



Fig. 3
 18-5013-03



18-5014-01

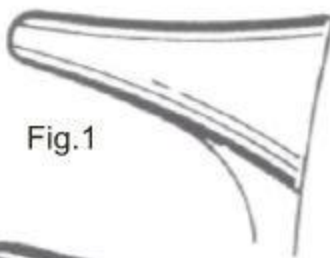

18-5015-01

18-5014-02

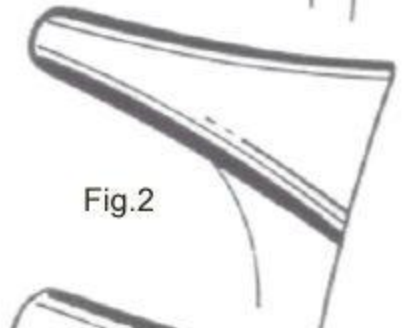

18-5015-02

18-5014-03

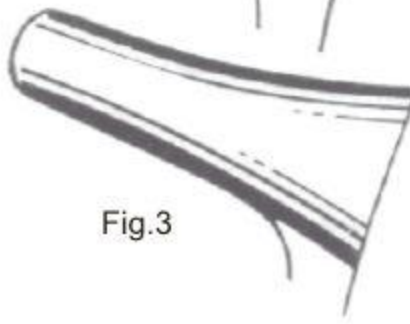

18-5015-03



Nasal Speculas ●— EN
 Nasenspekula ●— DE
 Espéculos nasales ●— ES



Cottle
 18-5017-01
 18-5017-02
 18-5017-03
 18-5017-04
 15 cm/6"

Cottle
 18-5018-01
 18-5018-02
 18-5018-03
 18-5018-04
 15 cm/6"

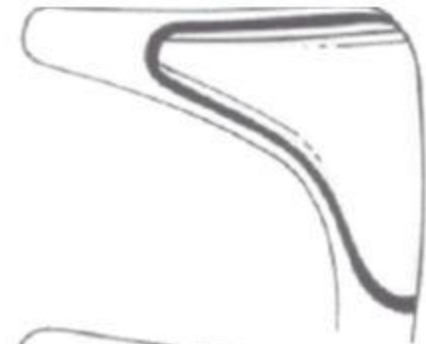

Fig 1
 18-5017-01
 18-5018-01
 35 mm



Fig 2
 18-5017-02
 18-5018-02
 50 mm



Fig 3
 18-5017-03
 18-5018-03
 75 mm

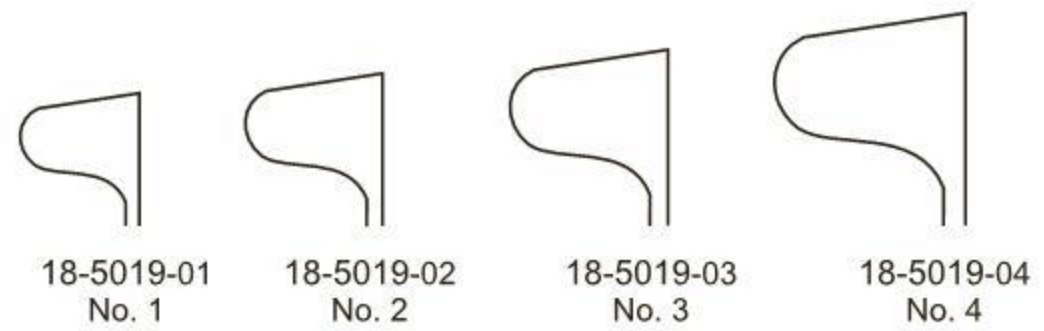

Fig 4
 18-5017-04
 18-5018-04
 90 mm



Thudicum Nasal Speculum
 Length 7 cm

- 18-5019-30 No. 1-3 (set of 3)
- 18-5019-40 No. 1-4 (set of 4)
- 18-5019-70 No. 1-7 (set of 7)



18-5019-01
 No. 1

18-5019-02
 No. 2

18-5019-03
 No. 3

18-5019-04
 No. 4

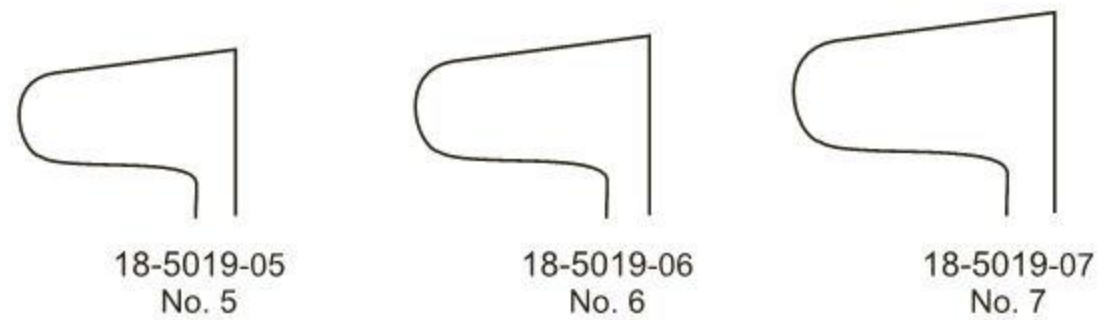

18-5019-05
 No. 5

18-5019-06
 No. 6

18-5019-07
 No. 7

EN —● Nasal Snares, Dressing and Tampon Forceps
 DE —● Polypenschnürer, Tamponpinzetten und -zangen
 ES —● Polipótomos, Pinzas para compresas y tanopamientos



Krause
18-5020-26
26 cm/10¼"



Krause-Voss
18-5021-26
26 cm/10¼"



Lange-Wilde
18-5022-24
24 cm/9½"

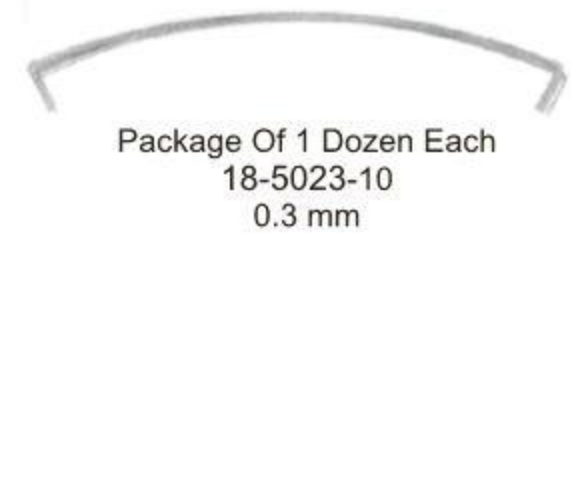

Package Of 1 Dozen Each
18-5023-10
0.3 mm



Cm	In
15.0	6
18.0	7
20.0	8



Cm	In
15.0	6
18.0	7
20.0	8



Westmacott (West)
18-5026-20
20 cm/8"



Lubet-Barbon
18-5027-20
20 cm/8"

Nasal Polypus and Septum Compression Forceps ● EN

Polypenzangen, Septumzange ● DE

Pinzas para pólipos, Pinza para el tabique nasal ● ES



Hartmann
18-5028-16
16 cm/6 1/4"

Hartmann
18-5029-20
20 cm/8"

Heymann
18-5030-18
18 cm/7"

Craig
18-5031-18
18 cm/7"

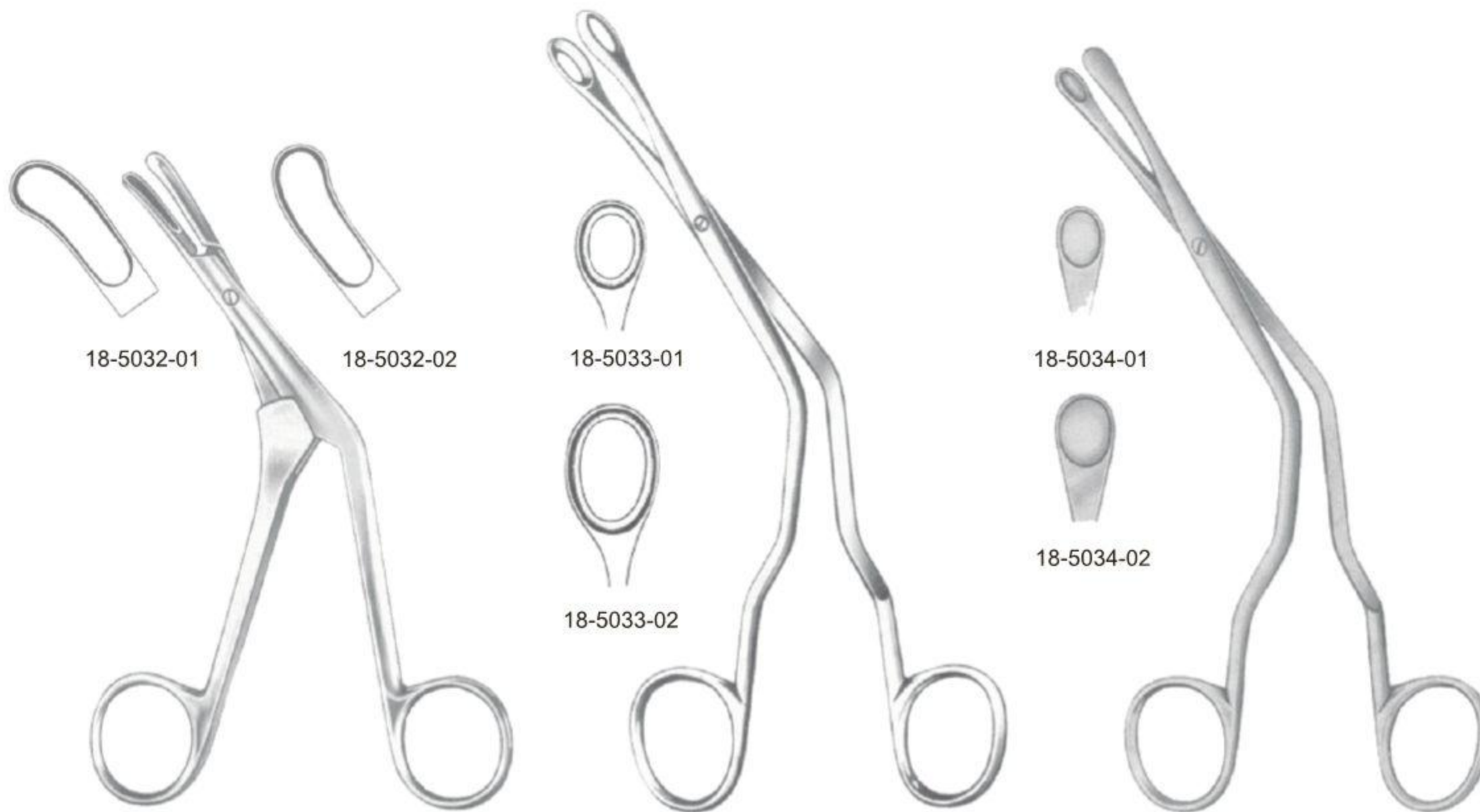

Craig Domnick
18 cm/7"

Luc
20 cm/8"

Luc
20 cm/8"



Bruenings
19 cm/7½"



Takahashi
19 cm/7½"



Watson-Williams
19 cm/7½"



Ferris-Smith
18-5038-12
19 cm/7½"

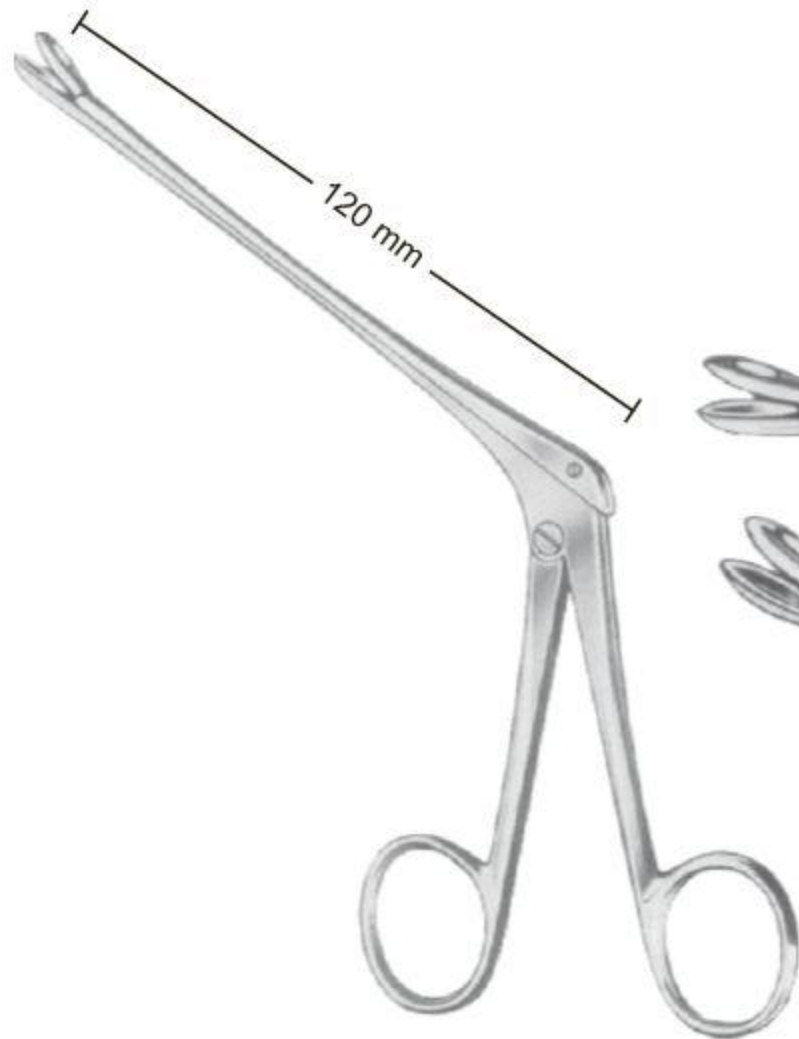

Weil-Blakesley

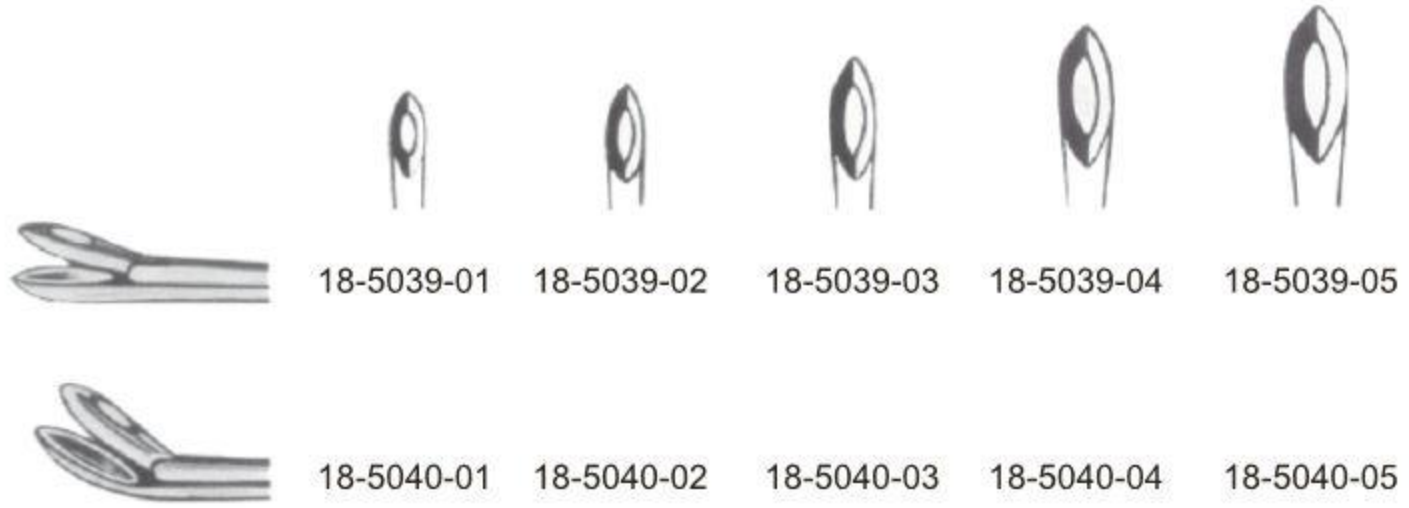

Struycken

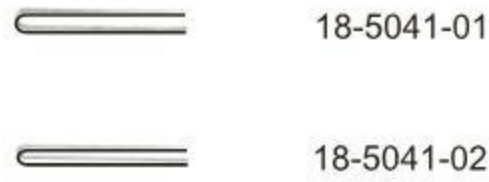

Hajek

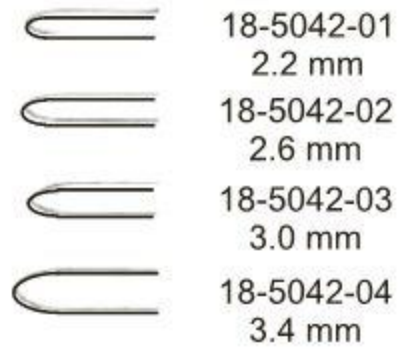

Myles

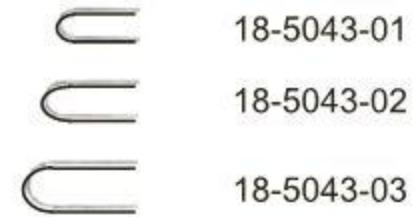

Grunwald

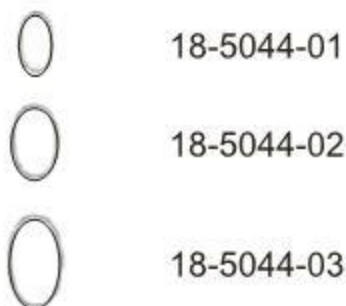

Hartmann

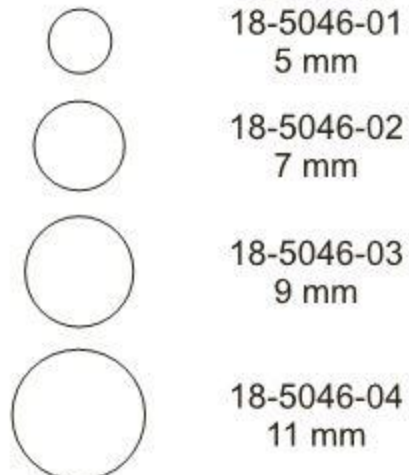

Schmeden

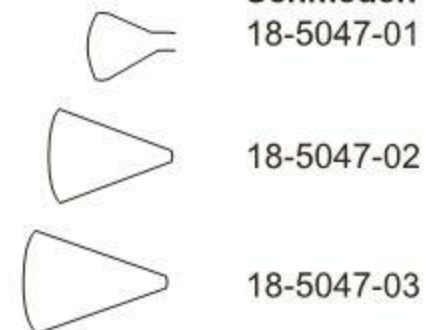

Grunwald
18-5045-01



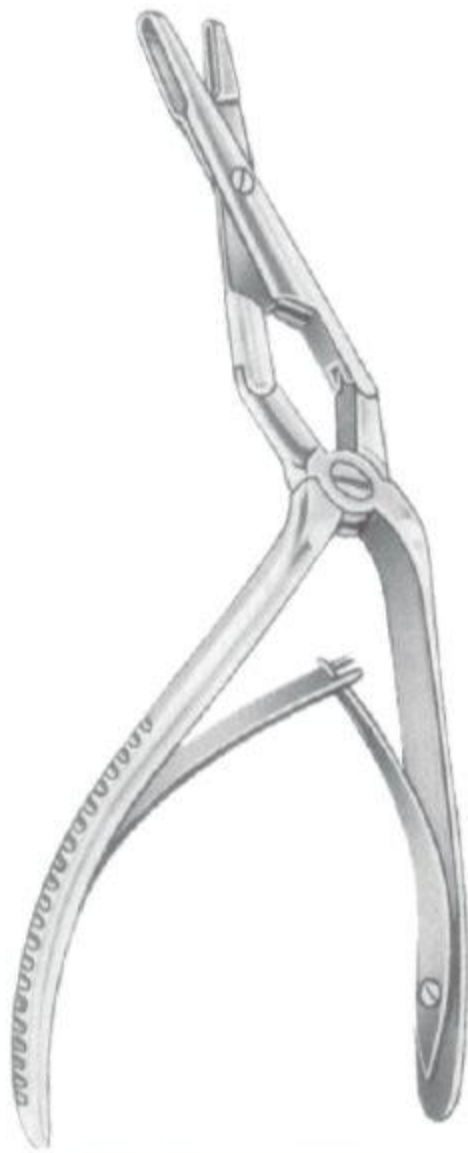

Middleton-Jansen
18-5048-19
19 cm/7½"

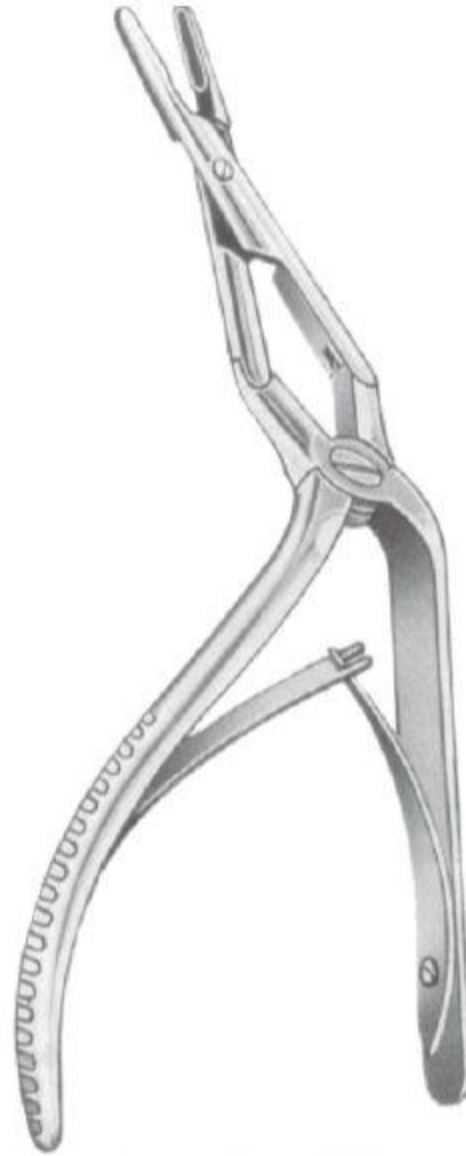

Middleton-Jansen
18-5049-19
19 cm/7½"



Kazanjian
18-5050-18
18 cm/7"



Caplan
18-5051-20
20 cm/8"

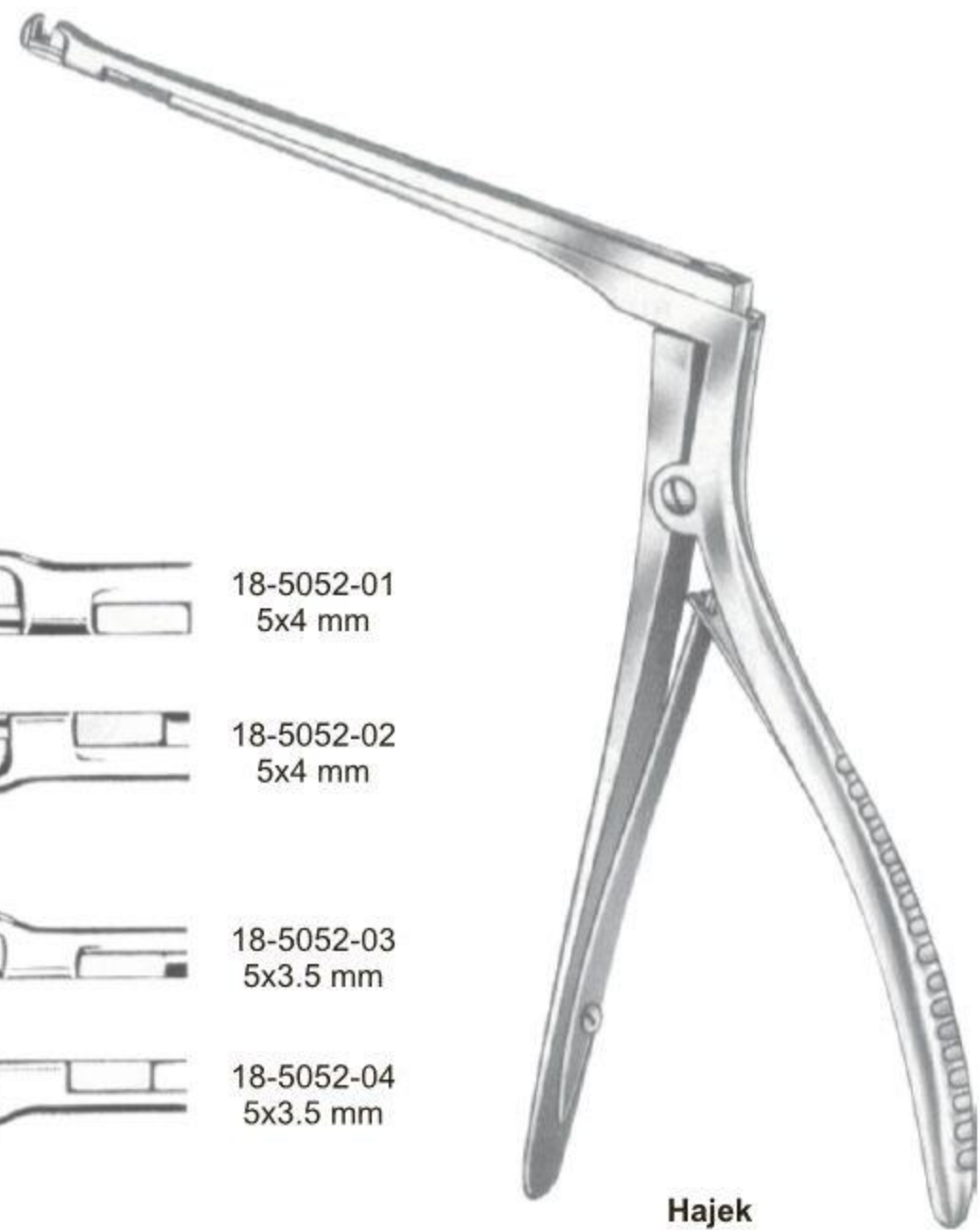
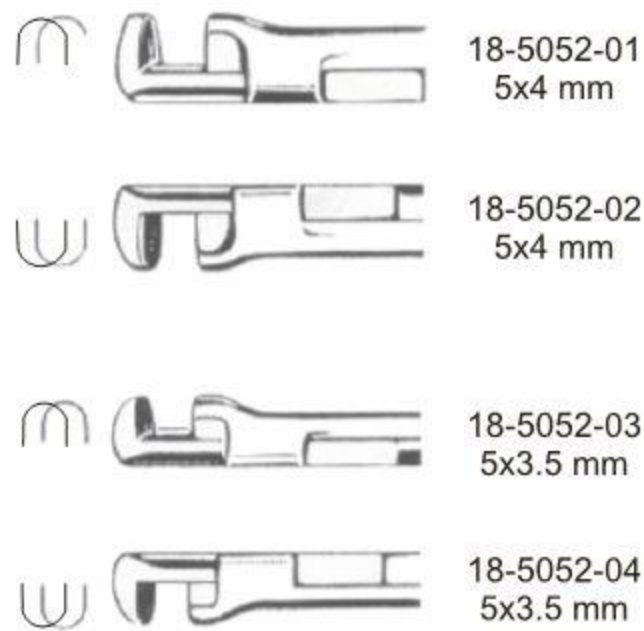

**Hajek
(Hajek-Kofler)
Shaft**
14 cm/5½"



Ferris-Smith-Kerrison



Ferris-Smith-Kerrison

	Width of Bite	Length of Shaft			Width of Bite	Length of Shaft		
		15 cm/6"	20 cm/8"	18 cm/7"		15 cm/6"	20 cm/8"	18 cm/7"
Cutting Upward 	18-5053-03	3 mm	18-5056-03	18-5059-03	1 mm	18-5061-03	18-5064-03	18-5067-01
	18-5053-05	5 mm	18-5056-05	18-5059-05	2 mm			18-5067-02
					3 mm			18-5067-03
					4 mm			18-5067-04
					5 mm			18-5067-05
Cutting Upward 40° 	18-5054-03	3 mm	18-5057-03		1 mm	18-5062-03	18-5065-03	18-5068-01
	18-5054-05	5 mm	18-5057-05		2 mm			18-5068-02
					3 mm			18-5068-03
					4 mm			18-5068-04
					5 mm			18-5068-05
Cutting Downward 	18-5055-03	3 mm	18-5058-03	18-5060-03	1 mm	18-5063-03	18-5066-03	18-5069-01
	18-5055-05	5 mm	18-5058-05	18-5060-05	2 mm			18-5069-02
					3 mm			18-5069-03
					4 mm			18-5069-04
					5 mm			18-5069-05



360° Turnable

Hajek-Kofler
 18-5070-16
 16 cm/6½"

- 18-5071-03
3 mm
- 18-5071-04
4 mm
- 18-5071-05
5 mm
- 18-5071-06
6 mm



Kerrison
 20 cm/8"



Jurasz
22 cm/8¾"



18-5072-01

18-5072-02

18-5072-03

Rhinoplastic and Nasal Knives

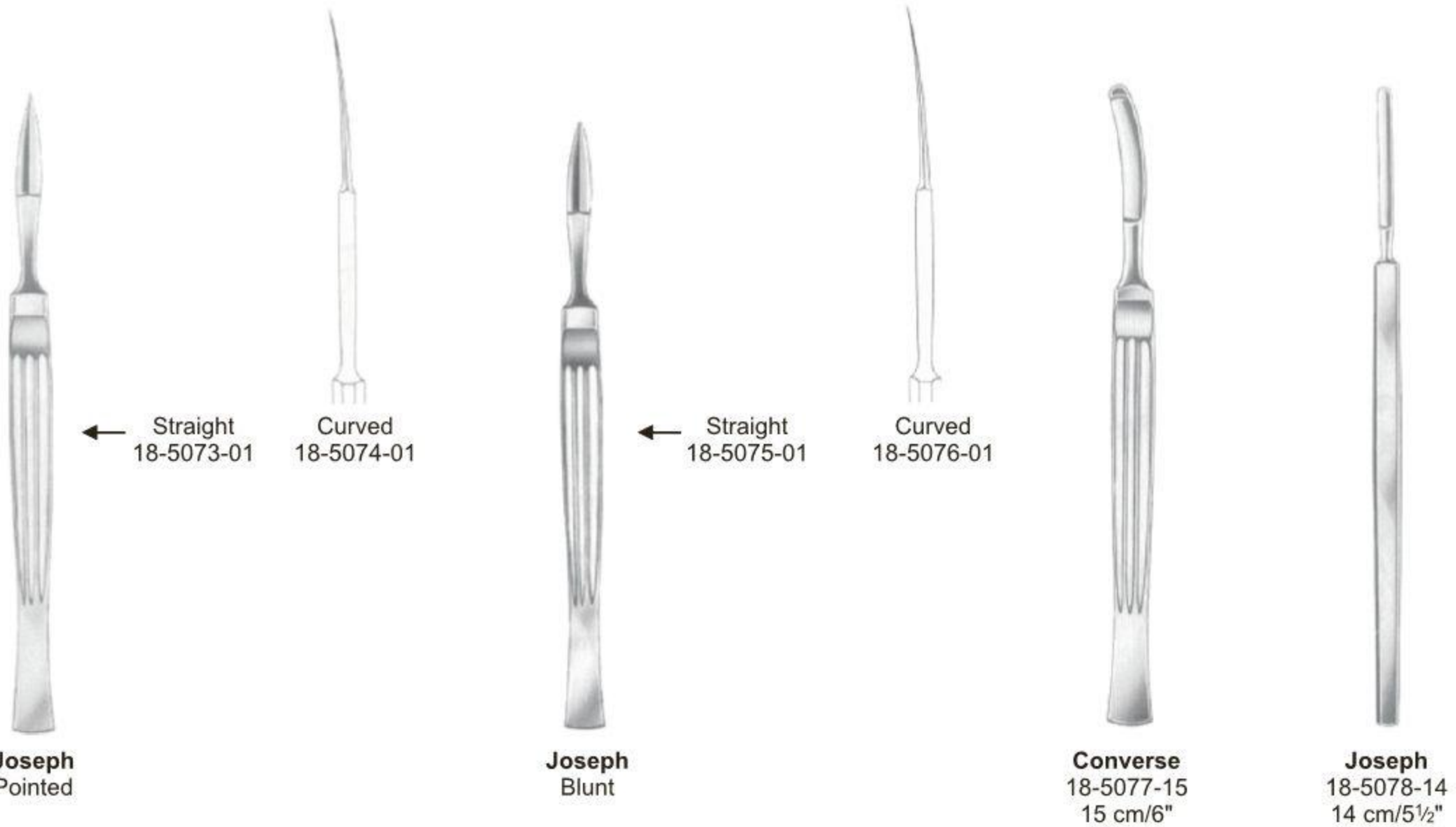

← Straight
18-5073-01

Curved
18-5074-01

← Straight
18-5075-01

Curved
18-5076-01

Joseph
Pointed

Joseph
Blunt

Converse
18-5077-15
15 cm/6"

Joseph
18-5078-14
14 cm/5½"



Cottle
 18-5079-15
 15 cm/6"



Cottle
 18-5080-14
 14 cm/5½"



Freer
 18-5081-16
 16 cm/6¼"



Joseph
 18-5082-16
 16.5 cm/6½"



Maltz
 18-5083-16
 16.5 cm/6½"



Freer
 18-5084-19
 19 cm/7½"

Septum Knives



Ballenger
 20cm/8"



18-5085-03 3 mm 18-5086-03
 18-5085-04 4 mm 18-5086-04
 18-5085-05 5 mm 18-5086-05



Ballenger
 20cm/8"



Bruenings
 18-5087-16



18-5088-04 4 mm
 18-5088-05 5 mm

Mc Kenty
15 cm/6"



Halle
18-5089-16
16.5 cm/6½"



Joseph
18-5090-16
16.5 cm/6½"



Cottle
18-5091-19
19.5 cm/7½"



Blunt

Freer
18-5092-19
19 cm/7½"



Sharp

Freer
18-5093-19
19 cm/7½"



Freer
18-5094-18
18 cm/7"



Freer-Yasargil
18-5095-18
18.5 cm/7¼"



Howarth
18-5096-21
21.5 cm/8½"



Mc Kenty
18-5097-22
22 cm/8¾"

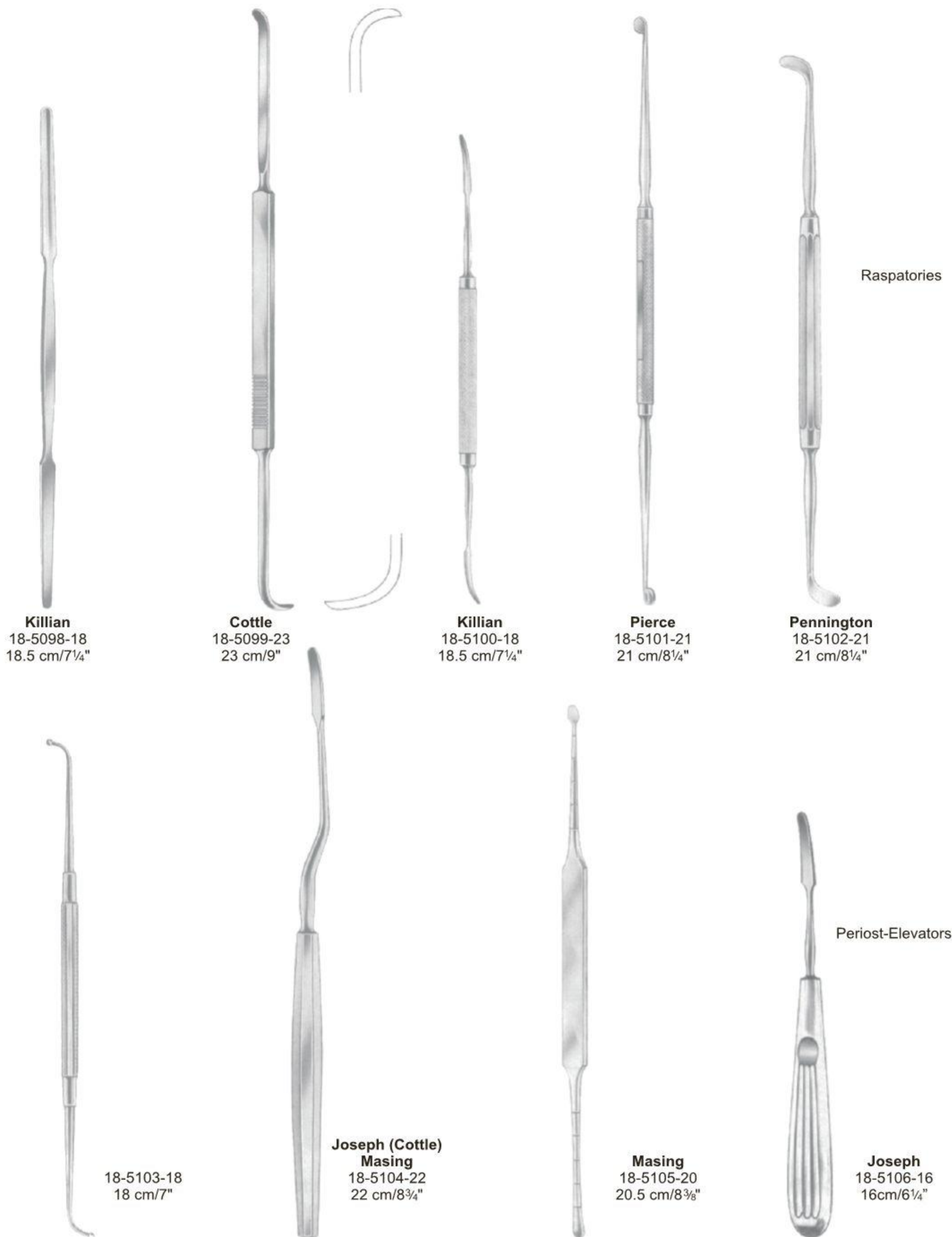

Killian
18-5098-18
18.5 cm/7 1/4"

Cottle
18-5099-23
23 cm/9"

Killian
18-5100-18
18.5 cm/7 1/4"

Pierce
18-5101-21
21 cm/8 1/4"

Pennington
18-5102-21
21 cm/8 1/4"

18-5103-18
18 cm/7"

**Joseph (Cottle)
Masing**
18-5104-22
22 cm/8 3/4"

Masing
18-5105-20
20.5 cm/8 3/8"

Joseph
18-5106-16
16cm/6 1/4"

Raspatories

Periost-Elevators

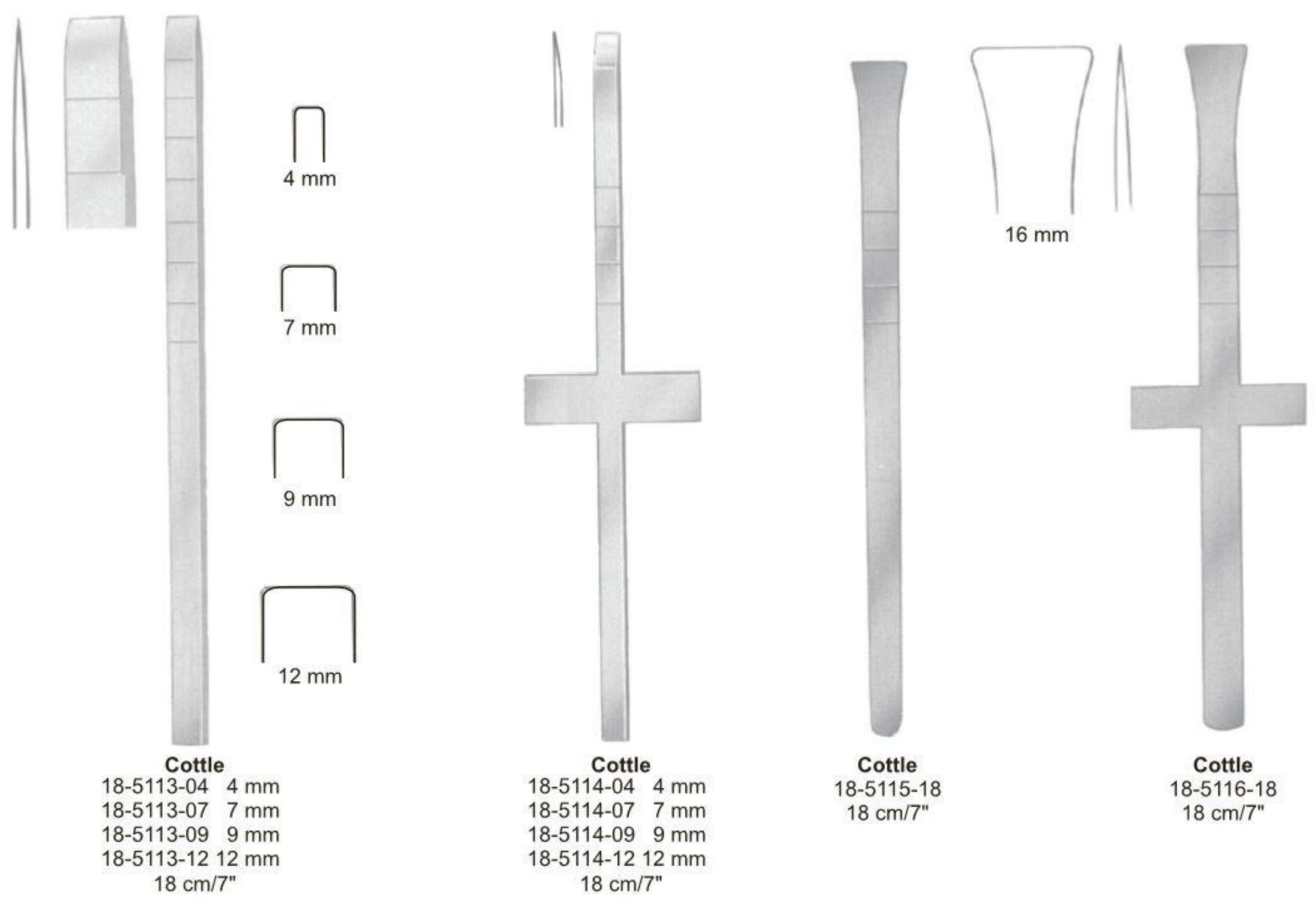
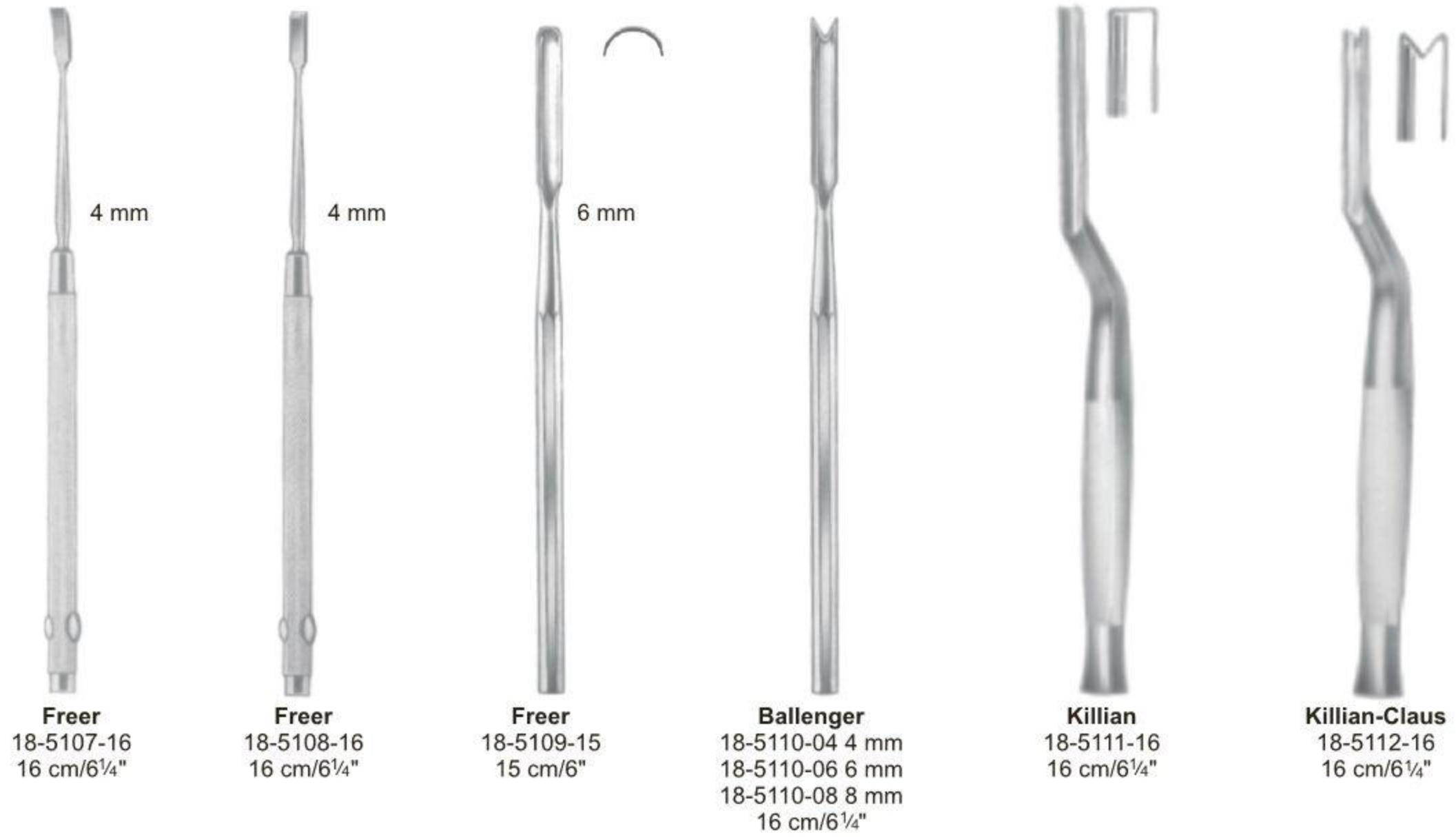

Nasal Septum Chisels ●— EN
 Nasenscheidewand Meißel ●— DE
 Tabique nasal Cinceles ●— ES

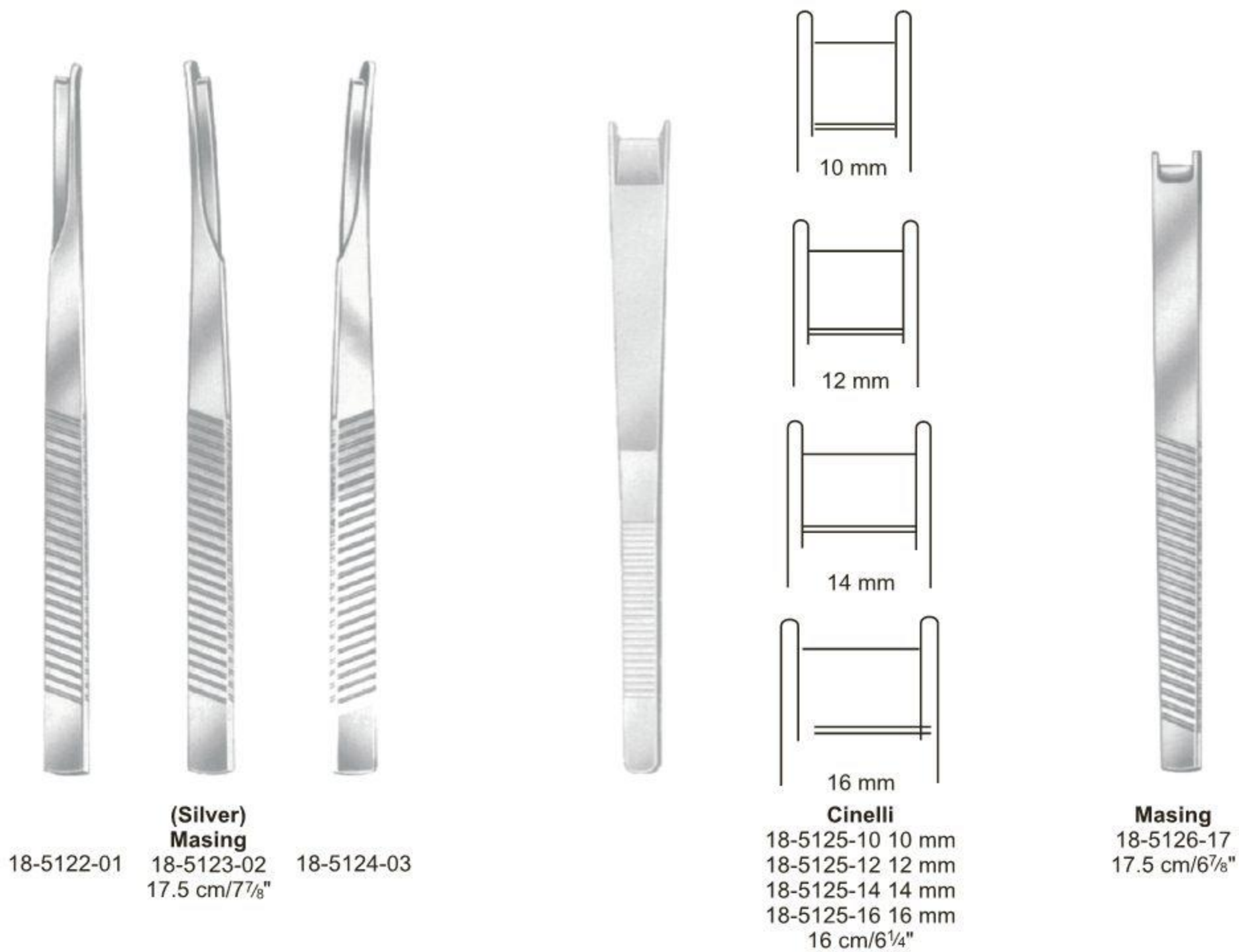



West
18-5127-16
16 cm/6¼"



West
18-5128-16
16 cm/6¼"



18-5129-01

18-5129-02

Joseph
17 cm/6¾"



Joseph
18-5130-01
17 cm/6¾"



Joseph
18-5131-02
17 cm/6¾"



Joseph
18-5132-03
17 cm/6¾"

Rasps with TC ●— EN
 Raspeln mit TC ●— DE
 Escofinas con TC ●— ES

TC



Fig.1



Fig.3



Fig.5



Fig.7



Fig.9



Fig.2



Fig.4



Fig.6



Fig.8



Fig.10

Famon

- Fig. 1/ 2 18-5133-12
- Fig. 3/ 4 18-5133-34
- Fig. 5/ 6 18-5133-56
- Fig. 7/ 8 18-5133-78
- Fig. 9/10 18-5133-90

21 cm/8 1/4"

TC



Parkes

- Fig. 1 18-5134-01
- Fig. 2 18-5134-02
- Fig. 3 18-5134-03
- Fig. 4 18-5134-04
- Fig. 5 18-5134-05
- Fig. 6 18-5134-06
- Fig. 7 18-5134-07
- Fig. 8 18-5134-08
- Fig. 9 18-5134-09
- Fig.10 18-5134-10

20.5 cm/8 1/8"

Maltz

- Fig. 1 18-5135-01
- Fig. 2 18-5135-02
- Fig. 3 18-5135-03
- Fig. 4 18-5135-04
- Fig. 5 18-5135-05
- Fig. 6 18-5135-06
- Fig. 7 18-5135-07
- Fig. 8 18-5135-08
- Fig. 9 18-5135-09
- Fig.10 18-5135-10

17 cm/6 3/4"



Maltz
18-5141-18
18 cm/7"



Joseph
16 cm/6¼"

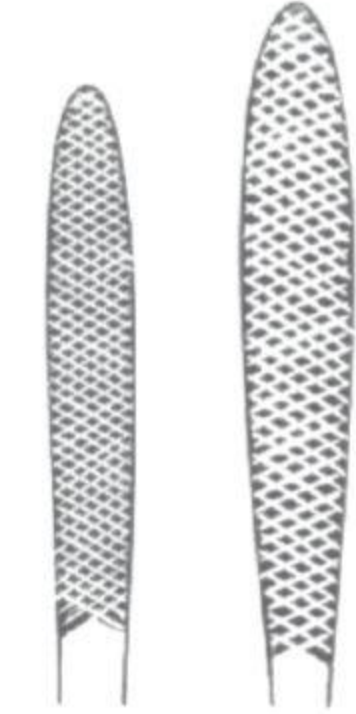

18-5142-01

18-5142-02



Lewis
18 cm/7"



Fine
18-5143-01



Coarse
18-5143-02



Cottle
18-5144-21
21 cm/8¼"



Aufricht
21 cm/8¼"

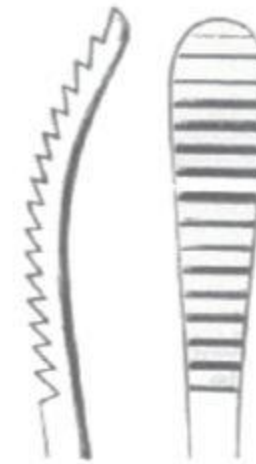

18-5145-01

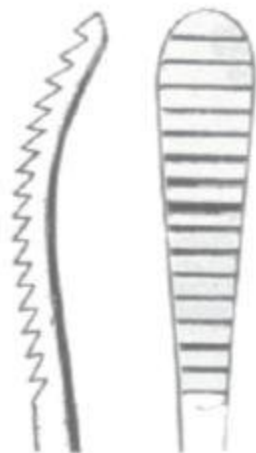

18-5145-02

Rasps with TC ●— EN
 Raspeln mit TC ●— DE
 Escofinas con TC ●— ES



Maltz
 17 cm/6¾"



18-5136-01



18-5136-02



Miller
 16 cm/6¼"



18-5137-01



18-5137-02



19 cm/7½"



18-5138-02



18-5138-03



18-5138-04



18-5138-05



18-5138-06



18-5138-07



Aufricht
 18-5139-17
 17.5 cm/6⅞"



Fomon
 18-5140-21
 21 cm/8¼"



Hooks



Fomon
18-5146-14
14.5 cm/5 3/4"



Cottle
18-5147-14
14.5 cm/5 3/4"



Cottle
18-5148-14
14.5 cm/5 3/4"



Cottle
18-5149-14
14.5 cm/5 3/4"



Cottle
18-5150-16
15 cm/6"



Kilner
18-5151-08
8 cm/3 1/8"
10 mm

Columella Forceps



Converse
18-5152-12
12 cm/4 3/4"

Aufricht
18-5153-16
16 cm/6 1/4"



Cottle
18-5154-10
10 cm/4"

Tissue Lifter



18-5155-14
14 cm/5 1/2"

Tissue Picks



18-5156-11
11 cm/4 3/8"



1.0 mm 18-5157-10
1.8 mm 18-515718

Septum Straightening and Septum Punch Forceps ● EN

Septum Straightening und Septum Punch-Zange ● DE

Tabique y tabique Straighting perforación Pinzas ● ES



Walsham
23 cm/9"



18-5158-01



18-5158-02



18-5158-03



Cottle-Walsham
18-5159-22
22 cm/8¾"



Asch
18-5160-23
23 cm/9"



Kressner
18-5161-20
20 cm/8"



Rubin
18-5162-20
20 cm/8"



Faulkner
18-5163-21
21 cm/8¼"



Sewall
18-5164-20
20 cm/8"
6 mm



Coakley
17 cm/6¾"



18-5165-01



18-5165-02



18-5165-03



18-5165-04



18-5165-05



18-5165-06

Ringmesser



Beckmann
22 cm/8¾"

18-5166-01



18-5167-01

18-5166-02



18-5167-02

18-5166-03



18-5167-03

18-5166-04



18-5167-04

18-5166-05



18-5167-05

18-5166-06



18-5167-06

Adenoid Curettes



Negus
20 cm/8"

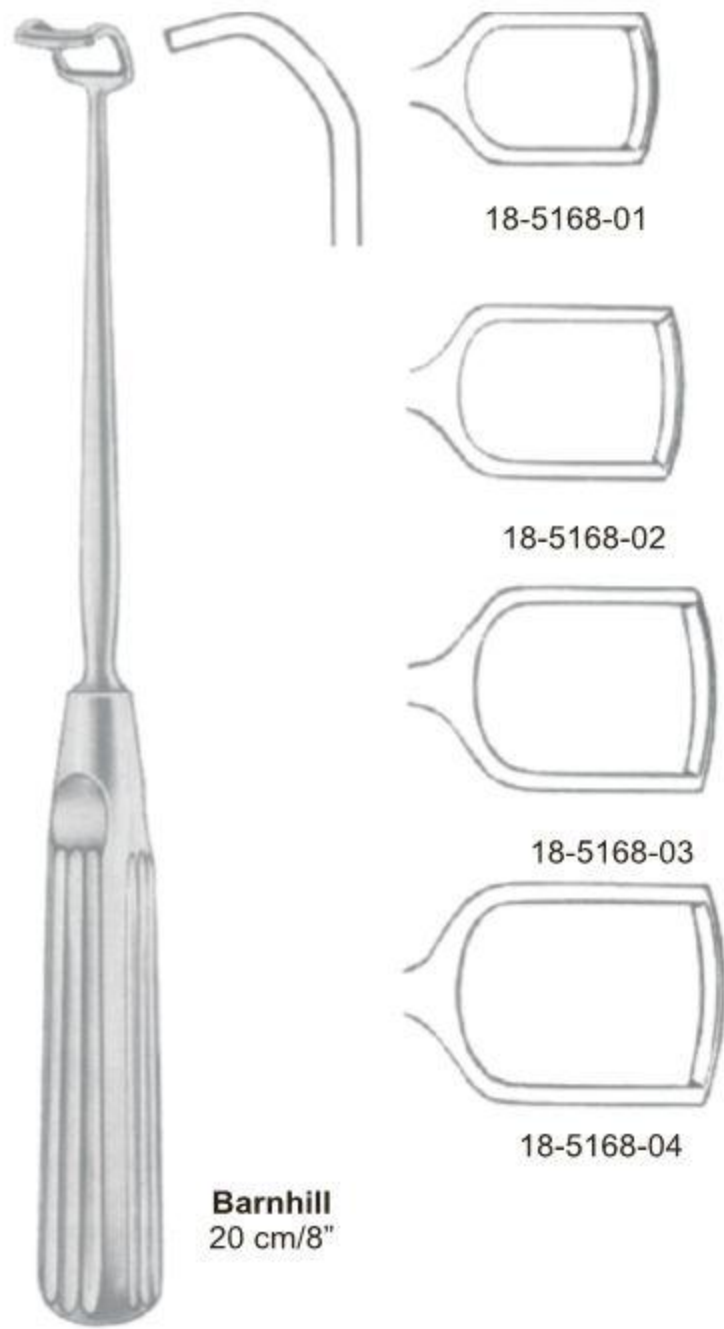

Barnhill
20 cm/8"

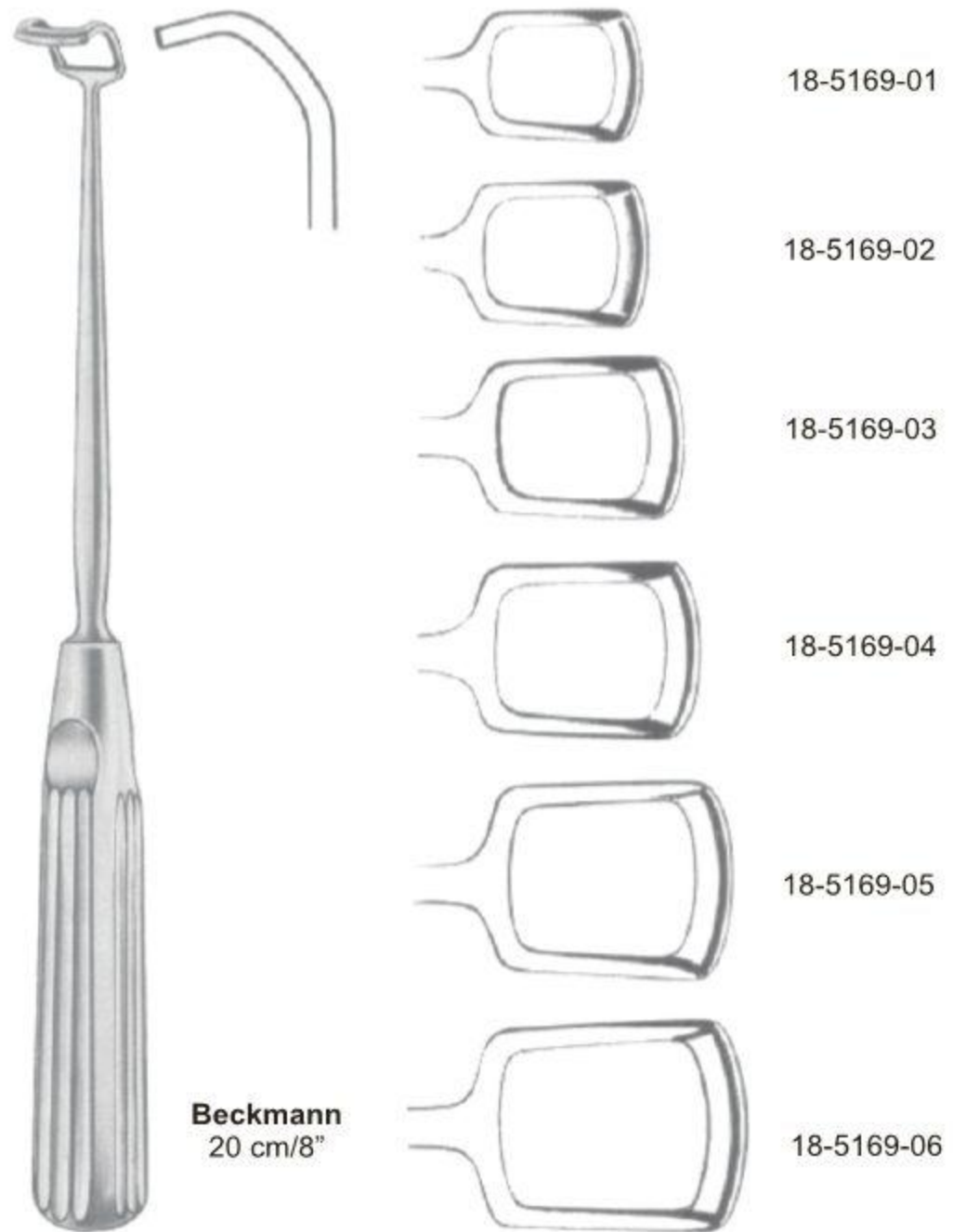

Beckmann
20 cm/8"

- 18-5170-10 10mm
- 18-5170-12 12mm
- 18-5170-14 14mm
- 18-5170-16 16mm
- 18-5170-18 18mm

- 18-5170-10A 10mm
- 18-5170-12A 12mm
- 18-5170-14A 14mm
- 18-5170-16A 16mm
- 18-5170-18A 18mm



St. Clair-Thompson
with graded
21.5cm/8 1/2"



St. Clair-Thompson
without graded
21.5cm/8 1/2"



La Force
23 cm/9"

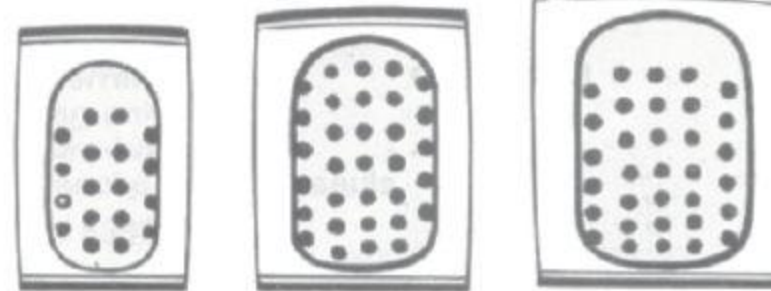

18-5171-01 18-5171-02 18-5171-03

Spare blades Only

18-5171-11 18-5171-12 18-5171-13

- EN —● Antrum Retractor and Antrum Frontal Sinus Wash Cannulas
 DE —● Nasal und Adenoid CuAntrum Retractor und Antrum Frontal Sinus Wash Kanülen
 ES —● Nasal y adenoides CuAntrum Retractor y el antro del seno frontal lavado cánulas



Bruenings- Brunk
18-5172-19
91 cm/7½"



Siebenmann



mm Ø		
18-5173-15	1.5	18-5174-15
18-5173-17	1.7	18-5174-17
18-5173-20	2.0	18-5174-20
18-5173-25	2.5	18-5174-25
18-5173-30	3.0	18-5174-30



Hartmann	
Fig. 1	Fig. 2
mm Ø	
18-5175-20	18-5176-20
18-5175-25	18-5176-25
18-5175-30	18-5176-30



Eicken - Killian
18-5177-03
3 mm Ø



Killian
18-5178-15
1.5 mm Ø



Ritter - Halle
2.5 mm 18-5179-25
3.0 mm 18-5179-30
4.0 mm 18-5179-40

- EN** Oral Instruments
- DE** Mund instrumente
- ES** Cirugía oral

Page 463 to 467



Gag Only
19-5251-10



Fig. 1
19-5251-01
65 x 28 mm

Kilner-Doughty
Complete
19-5251-00



Fig. 2
19-5251-02
75 x 32 mm

Fig. 3
19-5251-03
80 x 37 mm

Gag Only
19-5252-10

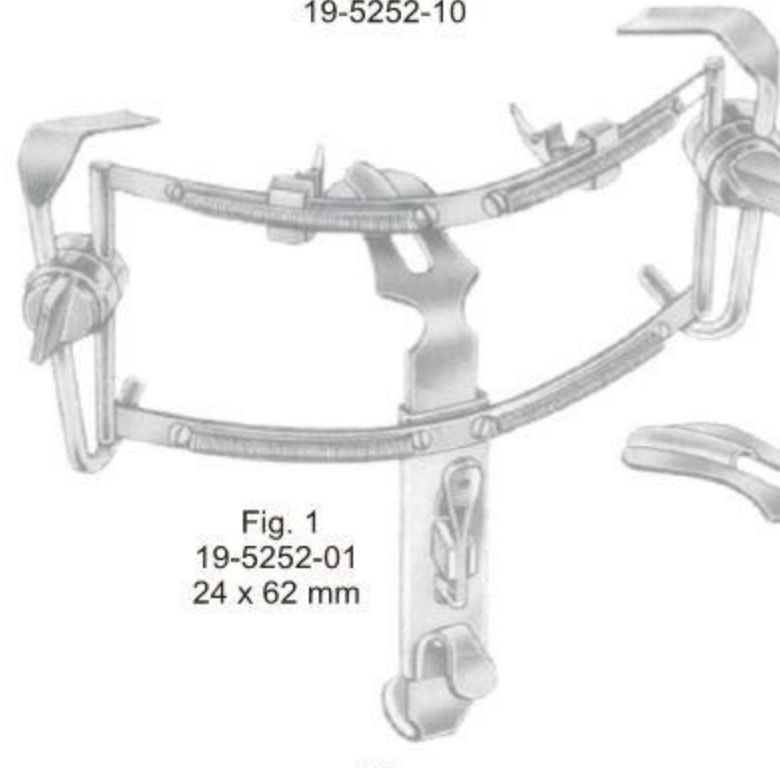

Fig. 1
19-5252-01
24 x 62 mm

Dingmann
Complete
19-5252-00



Fig. 2
19-5252-02
28 x 65 mm

Fig. 3
19-5252-03
31 x 75 mm

Gag Only
19-5253-10



Davis-Boyle
Complete
19-5253-00



Fig. 3
19-5253-03
24 x 80 mm

Fig. 5
19-5253-05
26 x 108 mm

Gag Only
19-5254-10



Mc Ivor
Complete
19-5254-00



Fig. 1
19-5254-01
23 x 70 mm

Fig. 2
19-5254-02
25 x 86 mm

Fig. 3
19-5254-03
26 x 100 mm

Fig. 1
19-5253-01
21 x 26 mm

Fig. 2
19-5253-02
23 x 65 mm

Fig. 4
19-5253-04
25 x 93 mm



Fig.	mm
2	19-5255-02 23 x 65
3	19-5255-03 24 x 80
4	19-5255-04 25 x 93
5	19-5255-05 26 x 108

Modell Wurzburg

Fig.	mm
1	19-5256-01 28 x 66
2	19-5256-02 32 x 75
3	19-5256-03 34 x 83
4	19-5256-04 37 x 93
5	19-5256-05 38 x 100



Chest Support for Mouth gag
 19-5257-00



Baby-Molt
 19-5258-10
 10 cm/4"



Molt
 19-5259-11 11 cm/4 1/4"
 19-5259-14 14 cm/5 1/2"



Roser-Konig
 19-5260-16 16 cm/6 1/4"
 19-5260-19 19 cm/7 1/2"

Mouth Gags



Denhart
 19-5261-12
 12 cm/4 3/4"



Heister
19-5262-13
13 cm/5"



Fergusson-Ackland
19-5263-18 18 cm/7"
19-5263-20 20 cm/8"

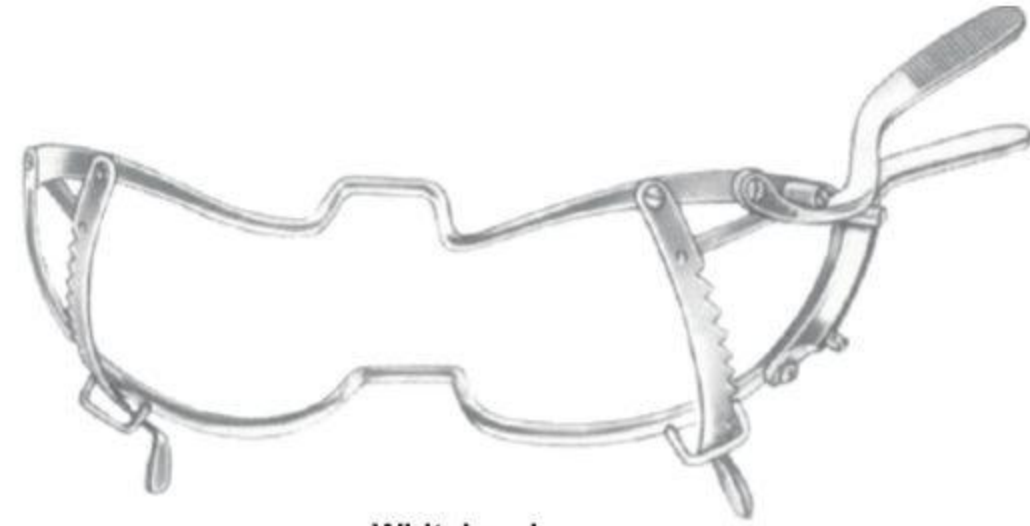

Whitehead
19-5264-11 11 cm/4 1/4"
19-5264-13 13 cm/5"
19-5264-15 15 cm/6"

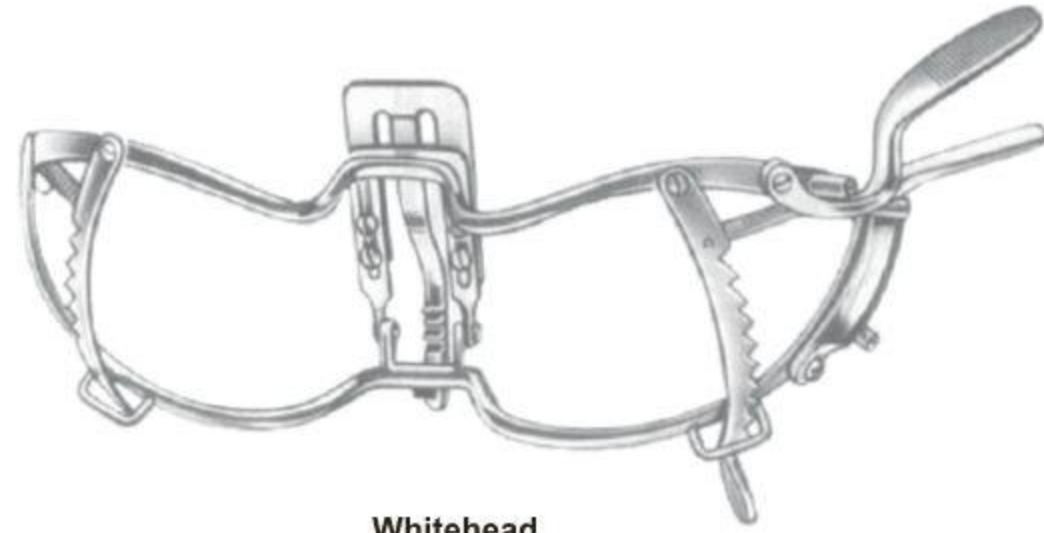

Whitehead
19-5265-13
13 cm/5"



Jennings
19-5266-09 09 cm/3 1/2"
19-5266-11 11 cm/4 1/4"
19-5266-13 13 cm/5"
19-5266-15 15 cm/6"



Sternberg
19-5267-12 12 cm/4 3/4"
19-5267-14 14 cm/5 1/2"
19-5267-16 16 cm/6 1/4"



19-5268-19
19 cm/7 1/2"



Moritz-Schmidt
19-5269-19
19 cm/7 1/2"



Lack
 19-5270-15
 Child 12 mm
 Adolescent 19 mm
 Adult 22mm



Hartmann
 19-5271-15
 15 cm/6"



Tobold
 19-5272-14
 14.5 cm/5 3/4"



Fraenkel
 19-5273-19
 19 cm/7 1/2"



Frenzel
 19-5274-16
 16.5 cm/6 1/2"



19-5275-13
 13 cm/5"



19-5276-14
 14.5 cm/5 3/4"



19-5277-14
 14.5 cm/5 3/4"



Kroenig
 19-5278-15
 15 cm/6"



Mayo
 19-5279-17
 17 cm/6 3/4"



Draffin Bipod

4 rings

19-5280-38 38.5cm/15"
19-5280-48 48cm/19"



Bruenings
19-5281-19
19 cm/7½"



Bruenings
19-5282-19
19 cm/7½"



Wieder



19-5283-01



19-5283-02

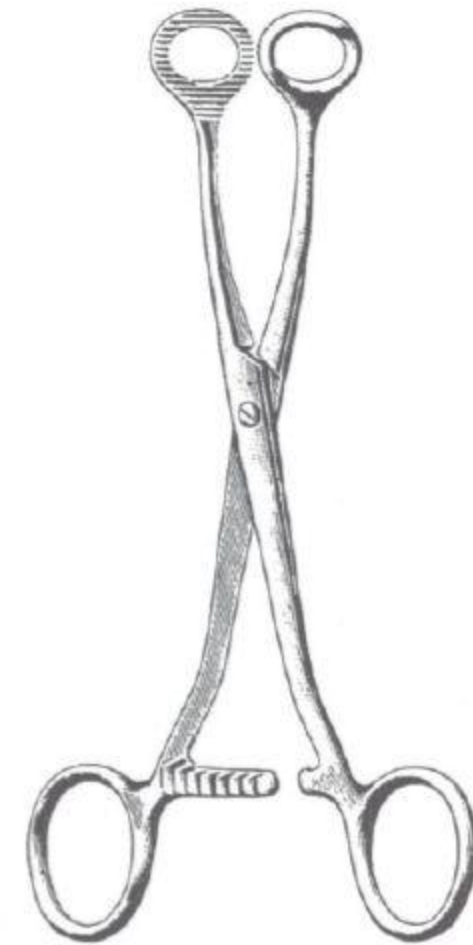

Collin
19-5284-16
16 cm/6¼"



Collin
19-5285-19
19 cm/7½"



19-5286-19
19 cm/7½"



Young
19-5287-17
17 cm/6¾"



Guys
19-5288-19
19 cm/7½"

Finger Protectors



Lengenbeck

19-5289-01 Ø 22.0 mm
19-5289-02 Ø 24.5 mm
19-5289-03 Ø 26.5 mm

- EN** Tonsil
- DE** Mandel
- ES** Amígdala

Page 468 to 474





Luniatschek
20-5351-18
18 cm/7"



Luniatschek
20-5352-18
18 cm/7"

Gauze Packers



Trelat
20-5353-23
23 cm/9"



Claus
20-5354-23
23 cm/9"



Hurd
20-5355-24
24 cm/9½"



Hurd
20-5356-21
21 cm/8¼"



Nager
20-5357-24
24 cm/9½"



Falk
20-5358-24
24 cm/9½"



Falk
20-5359-24
24 cm/9½"



Claus-Eicken
20-5360-23
23 cm/9"

Ligature Carrier



Roeder
20-5361-26
26 cm/10¼"

Cleft Palate knives and tonsil knives ● EN
 Nadeln zur gaumennaht, Tonsillennadeln ● DE
 Agujas para suturas del paladar, Agujas para suturas de amígdalas ● ES



20-5362-17
17.5 cm/6⁷/₈"



Fischer
20-5363-22
22.5 cm/8⁷/₈"



Douglas
20-5364-21
21 cm/8¹/₄"



Abraham
20-5365-21
21 cm/8¹/₄"



Bruenings
20-5366-23
23 cm/9"



Abraham
20-5367-19
19 cm/7¹/₂"



Canfield
20-5368-21
21 cm/8¹/₄"



Negus Knot Tier and Pusher
20-5369-20
20cm/8"



Molison Pillar
double ended
20-5370-21
21cm/8 ¼"



Gwynee Evans Dissector
double ended
20-5371-06
6mm, 20cm/8"
20-5372-06
8mm, 20cm/8"



Hurd
20-5373-22
22.5 cm/8 7/8"



Yankauer
20-5374-21
21 cm/8 ¼"



Luniatschek
20-5375-19
19 cm/7 ½"



Henke
23 cm/9"



20-5376-01



20-5376-02



Nager
20-5377-23
23 cm/9"



Love
23 cm/9"

Wide
20-5378-18 18 mm
20-5378-20 20 mm
20-5378-22 22 mm



Haslinger
20-5379-16



Hofer
20-5380-24
24 cm/9 ½"

Tonsil Seizing Forceps ● EN
 Tonsillenzangen ● DE
 Pinzas para coger las amígdalas ● ES



Museux
 Straight
 20-5381-20
 20 cm/8"

Curved
 20-5382-20
 20 cm/8"



Ballenger
 20-5383-21
 21.5 cm/8½"



White
 20-5384-18 18 cm/7"
 20-5384-23 23 cm/9"



Marschik Kroni
 20-5385-20
 20.5 cm/8"



Colver
 Straight
 20-5386-19
 19 cm/7½"

Curved
 20-5387-19
 19 cm/7½"



Blohmke
 20-5388-20
 20 cm/8"



Eves
20-5389-28
28 cm/11"



Eves
20-5390-28
28 cm/11"



Bruenings
20-5391-28
28 cm/11"



With 1 Straight Tip

Brown
20-5392-00



With 1 Straight Tip

Tyding
20-5393-00

Tonsillectomes ●— EN
 Tonsillotome ●— DE
 Amigdalótomos ●— ES



Sluder-Ballenger
 Complete, With 3 Tips
 20-5394-00

Tonsil Haemostats



Corwin
 20-5395-14
 14 cm/5½"

Tonsil Punch Forceps



20-5396-13 13 mm Ø
 20-5396-15 15 mm Ø
 20-5396-17 17 mm Ø

Hartmann



Denis Browne
 Tonsil Forceps
 20-5397-20
 20cm/8"



Luc Forceps
 20-5398-20 Small
 20-5399-20 Medium
 20-5400-20 Large
 20cm/8"



- 20-5401-06 Dia 6mm
- 20-5401-08 Dia 8mm
- 20-5401-10 Dia 10mm
- 20-5401-12 Dia 12mm
- 20-5401-14 Dia 14mm
- 20-5401-16 Dia 16mm
- 20-5401-18 Dia 18mm
- 20-5401-20 Dia 20mm
- 20-5401-22 Dia 22mm
- 20-5401-24 Dia 24mm
- 20-5401-26 Dia 26mm
- 20-5401-28 Dia 28mm
- 20-5401-30 Dia 30mm

Laryngeal Mirror
with metal handle
22cm/8 3/4"



Waugh Dissecting Forcep
20-5402-20
1 x 2 teeth
20cm/8"



Waugh Dissecting Forcep
20-5403-20
serrated
20cm/8"



Metzenbaum Scissor Cvd.
20-5404-18
18cm/7"

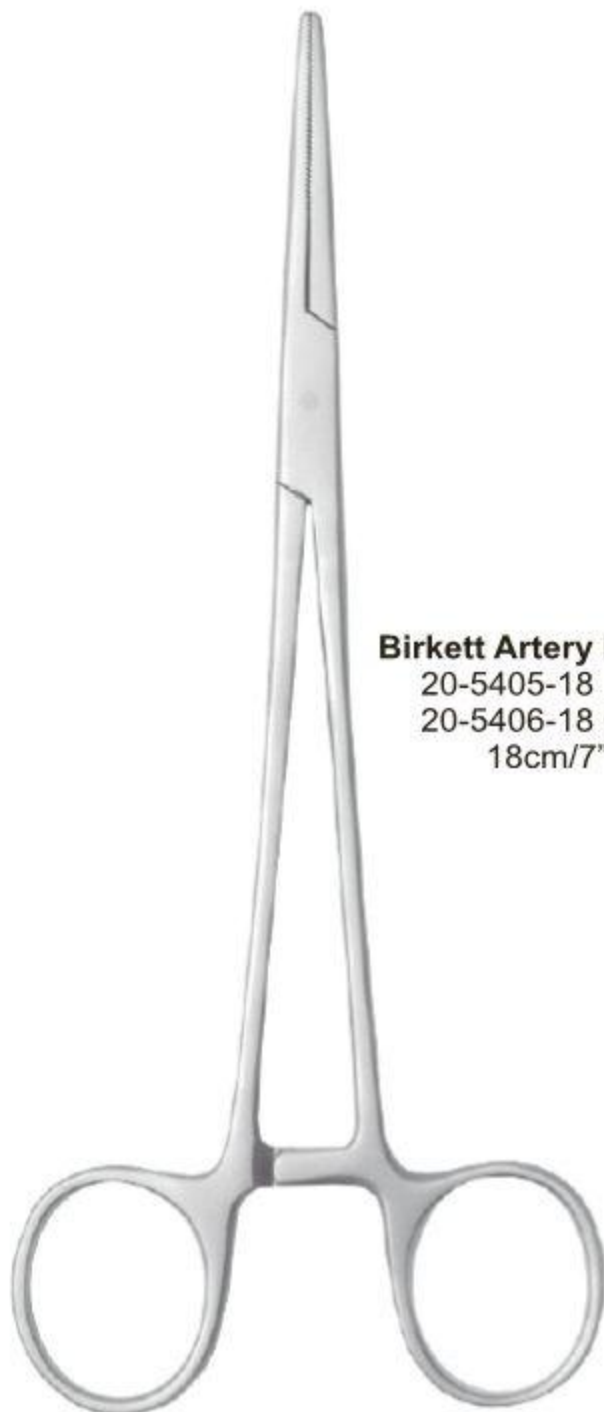

Birkett Artery Forcep
20-5405-18 Str.
20-5406-18 Cvd.
18cm/7"



Negus Artery Forcep
Large Curved
20-5407-18
18cm/7"

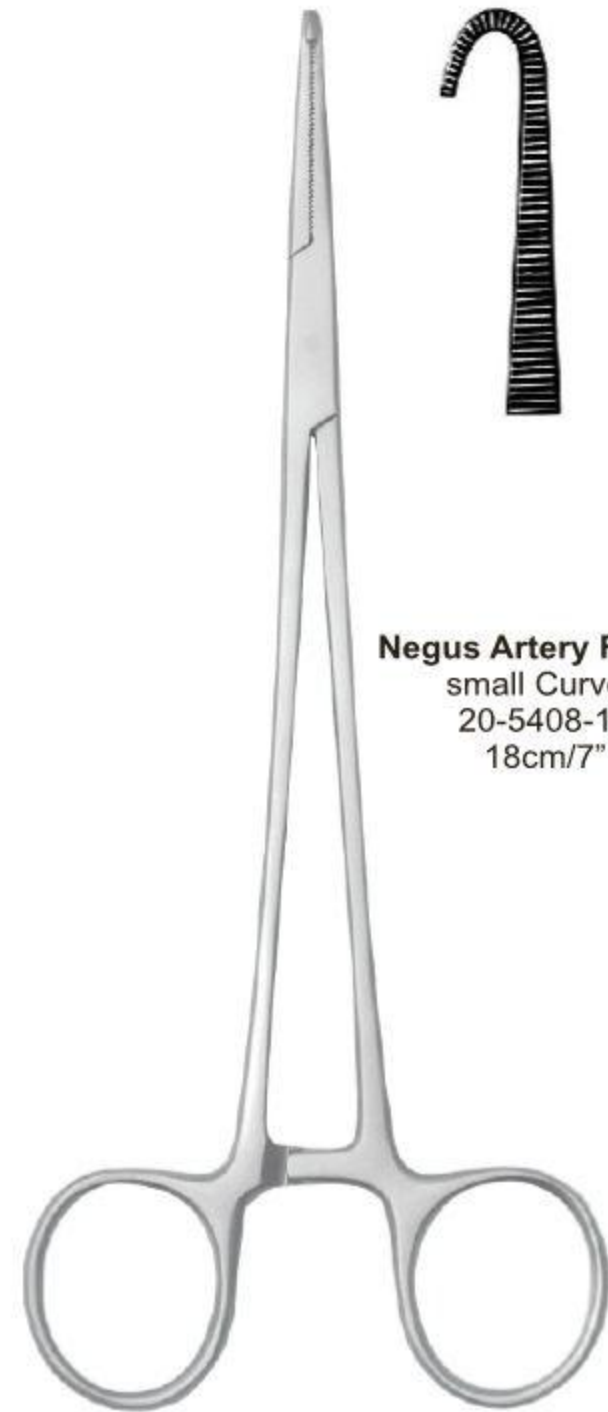

Negus Artery Forcep
small Curved
20-5408-18
18cm/7"

- EN** Tracheotomy
- DE** Tracheotomie
- ES** Traqueotomía

Page 475 to 479





Laborde
21-5551-13 13 cm/5"
21-5551-15 15 cm/6"



Trousseau (Adult)
21-5552-14
14 cm/5½"



Trousseau (Child)
21-5553-13
13 cm/5"

Hooks



Bose
21-5554-07
7 cm/2¾"

Left



21-5555-16

Right



21-5556-16

Sharp

Bose
16 cm/6¼"

Thyroid Gland Retractor



Schoenborn
21-5557-21
21 cm/8¼"

Trachea Trocars



Uckerman
21-5558-08 08 mm Ø
21-5558-10 10 mm Ø
13 cm/5"

International scale

Fig.	0	1	2	3	4	5	6	7	8	9
Diameter	④	⑤	⑥	⑦	⑧	⑨	⑩	⑪	⑫	⑬mm
Length of outer tube N	45	50	55	60	65	70	75	80	85	90mm



LUER

Fig	mmØ	45-90mm	95mm	105mm
0	4	21-5559-04		
1	5	21-5559-05		
2	6	21-5559-06		
3	7	21-5559-07		
4	8	21-5559-08	21-5560-08	21-5561-08
5	9	21-5559-09	21-5560-09	21-5561-09
6	10	21-5559-10	21-5560-10	21-5561-10
7	11	21-5559-11	21-5560-11	21-5561-11
8	12	21-5559-12	21-5560-12	21-5561-12
9	13	21-5559-13	21-5560-13	21-5561-13



CHEVALIER-JACKSON

Fig	mmØ	45-90mm
0	4	21-5562-04
1	5	21-5562-05
2	6	21-5562-06
3	7	21-5562-07
4	8	21-5562-08
5	9	21-5562-09
6	10	21-5562-10
7	11	21-5562-11
8	12	21-5562-12
9	13	21-5562-13

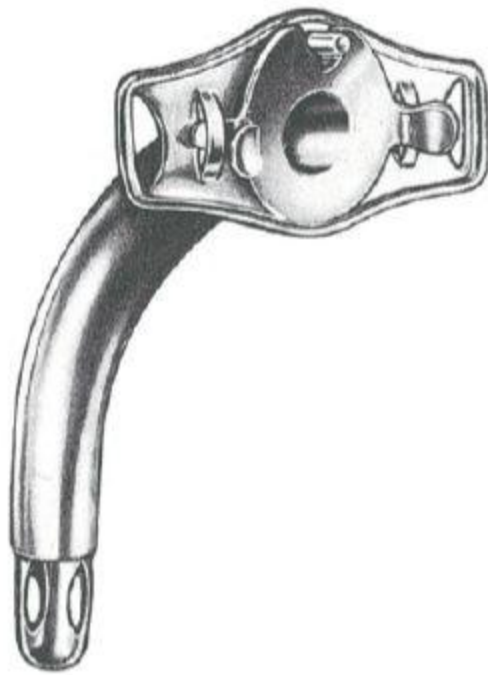

KRISHABER

Fig	mm	
0	4	21-5563-04
1	5	21-5563-05
2	6	21-5563-06
3	7	21-5563-07
4	8	21-5563-08
5	9	21-5563-09
6	10	21-5563-10
7	11	21-5563-11
8	12	21-5563-12



KRISHABER-LUER

Fig	mm	
0	4	21-5564-04
1	5	21-5564-05
2	6	21-5564-06
3	7	21-5564-07
4	8	21-5564-08
5	9	21-5564-09
6	10	21-5564-10
7	11	21-5564-11
8	12	21-5564-12

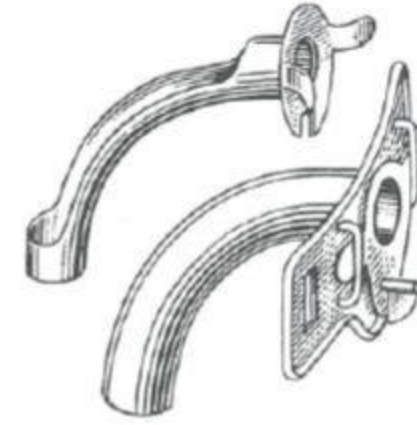

PARKER

Fig	F.G	
1	16	21-5565-16
2	18	21-5565-18
3	20	21-5565-20
4	22	21-5565-22
5	24	21-5565-24
6	26	21-5565-26
7	28	21-5565-28
8	30	21-5565-30
9	32	21-5565-32

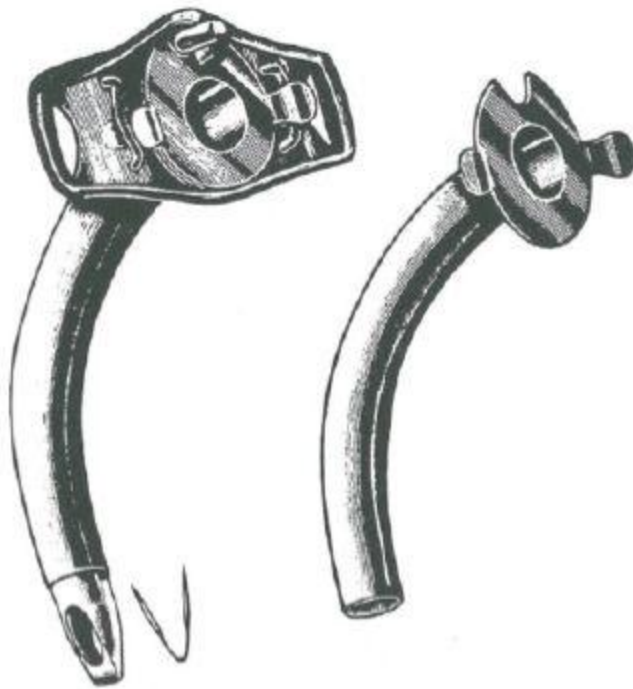

COLLIN

Fig	mm	
0	4	21-5566-04
1	5	21-5566-05
2	6	21-5566-06
3	7	21-5566-07
4	8	21-5566-08
5	9	21-5566-09
6	10	21-5566-10
7	11	21-5566-11
8	12	21-5566-12



FULLER

Fig	F.G	
1	18	21-5567-18
2	20	21-5567-20
3	22	21-5567-22
4	24	21-5567-24
5	26	21-5567-26
6	28	21-5567-28
7	30	21-5567-30
8	32	21-5567-32

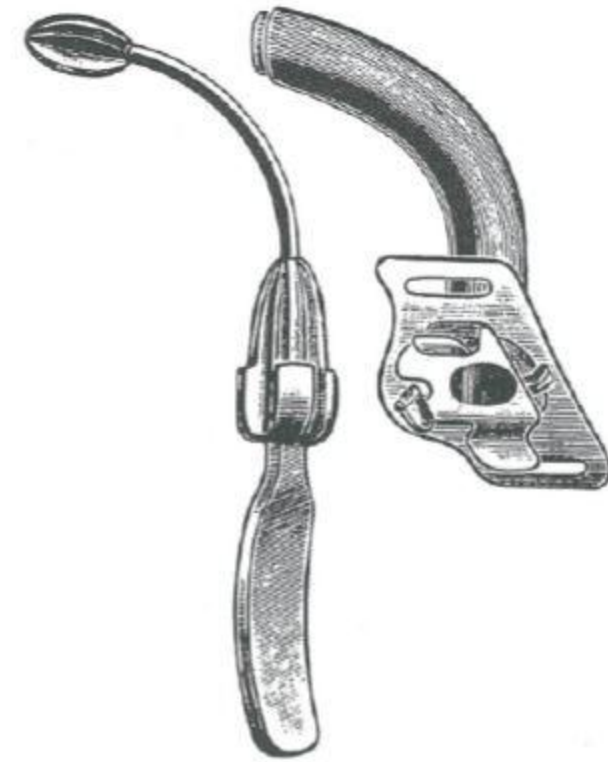

CUBLEY

Fig	F.G	
1	16	21-5568-16
2	18	21-5568-18
3	20	21-5568-20
4	22	21-5568-22
5	24	21-5568-24
6	26	21-5568-26
7	28	21-5568-28
8	30	21-5568-30
9	32	21-5568-32

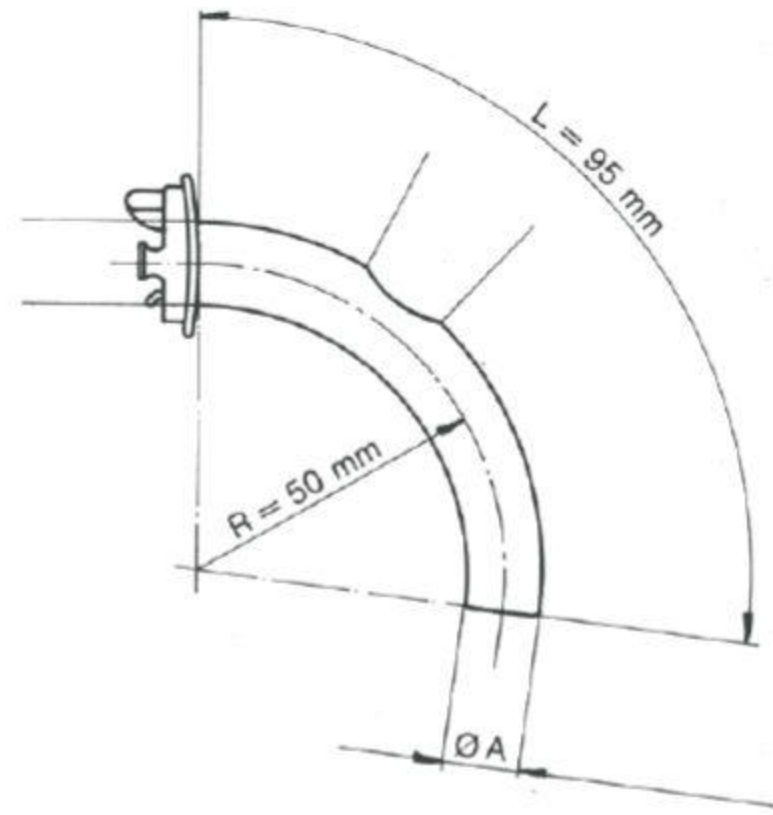
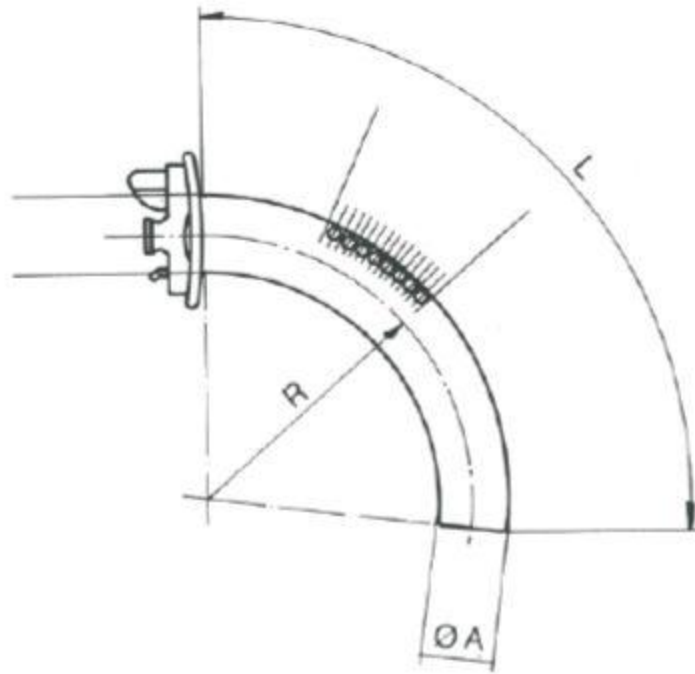
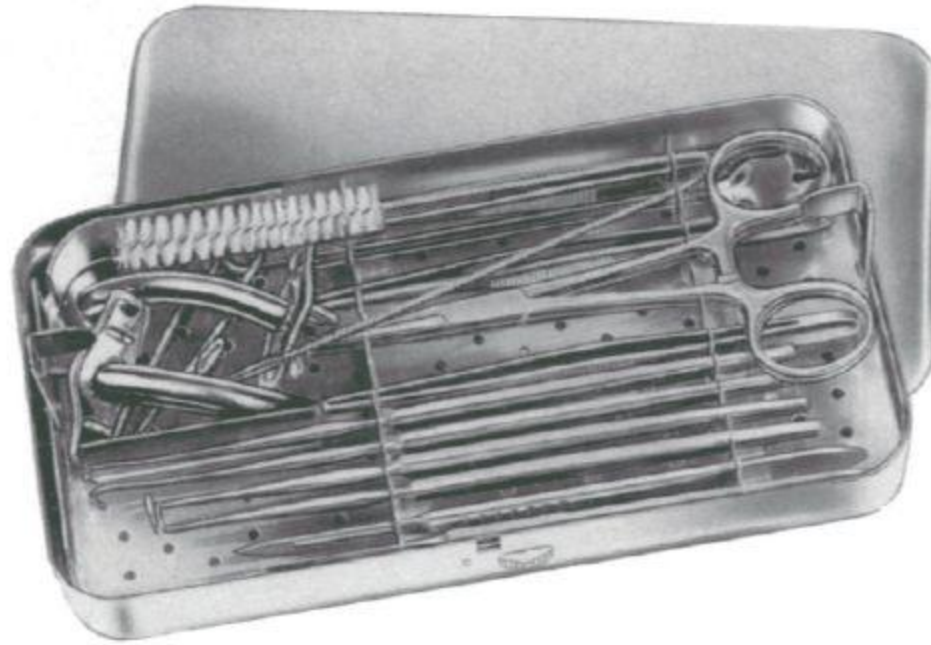

Fig		ØA	L	R
0	21-5569-08	8	65	36.5
1	21-5569-09	9	70	29
2	21-5569-10	10	75	40.5
3	21-5569-11	11	80	41.5
4	21-5569-12	12	85	43
5	21-5569-13	13	90	47.5

Fig		ØA	L	R
0	21-5570-08	8	95	50
1	21-5570-09	9	95	50
2	21-5570-10	10	95	50
3	21-5570-11	11	95	50
4	21-5570-12	12	95	50
5	21-5570-13	13	95	50



200 x 105 x 30mm

TRACHEOTOMY SET

21-5571-00

complete in metal case, consisting of:

- 1 Handle with 1 blade, Fig. 20
- 1 Handle with 1 blade, Fig. 23
- 1 Thumb forceps, 13.0cm
- 1 Tissue forcep, 13.0cm 1 x 2 teeth
- 2 Pean Artery Forceps, 13.0cm
- 1 Grooved Director, 14.0cm
- 1 Trachea Dilator
- 2 Iterson Trachea Retractors, blunt
- 1 Bose Trachea Retractor, sharp left hand side
- 1 ditto, right hand side
- 1 Luer Trachea Tube, Standard
- 1 ditto
- 1 Cleaning Brush

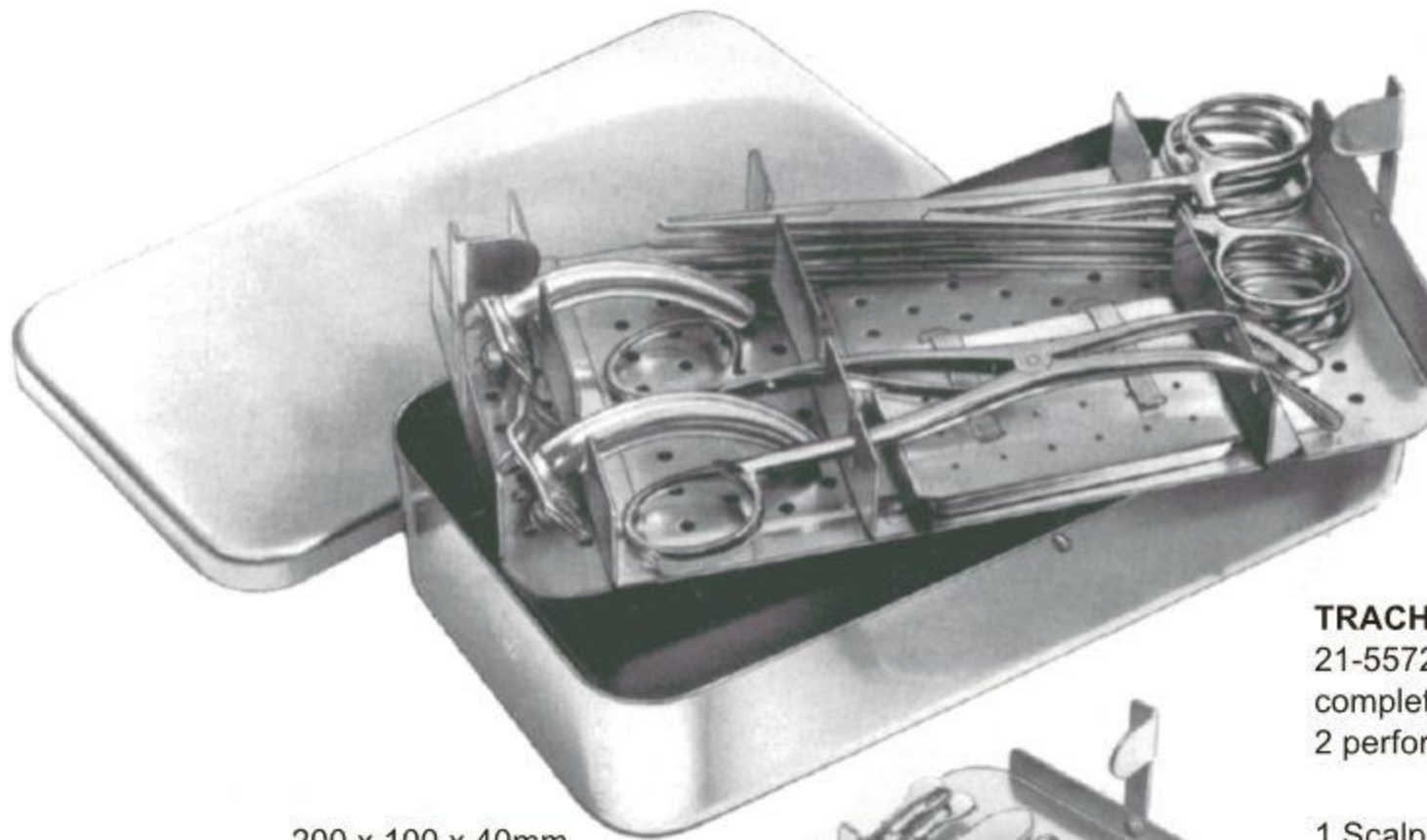

200 x 100 x 40mm

TRACHEOTOMY SET

21-5572-00

complete in metal case 200 x 100 x 40 mm, with 2 perforated trays of 18/8 s/s containing the following instruments:

- 1 Scalpel Handle No. 4, with blade No. 20
- 1 Scalpel Handle No. 4, with blade No. 23
- 3 Scalpel Blades, assorted, in perforated small case.
- 1 Small case for above Scalpel Blades
- 1 Dressing Forceps, serrated, 13.0cm
- 2 Tissue Forceps, 1 x 2 teeth, 13.0cm
- 4 Crile Artery Forceps, straight, 14.0cm
- 1 Grooved Director, 14.0cm
- 1 Trousseau Trachea Dilator, 14.0cm
- 2 Iterson Trachea Hooks, blunt
- 1 Bose Hook, sharp, left hand side, 16.0cm
- 1 ditto, right hand side, 16.0cm
- 1 Luer Trachea Tube, size 2.6mm diam. German Silver.
- 1 ditto, size 4.8mm diam, German Silver.
- 1 Cleaning Brush, 12mm diam. 26.0cm

- EN** Goitre
- DE** Kropfchirurgie
- ES** Bocio

Page 480

 **ORI-MED**
INSTRUMENTS



Scissors, Directors-Enucleators, Goitre Seizing Forceps, Muscular Clamp ●— EN
 Schere, Directors-Enucleators, Struma ergriff Pinzetten, Muscular Clamp ●— DE
 Tijeras, Directores Enucleators, pinzas bocio Aprovechando, Clamp Muscular ●— ES

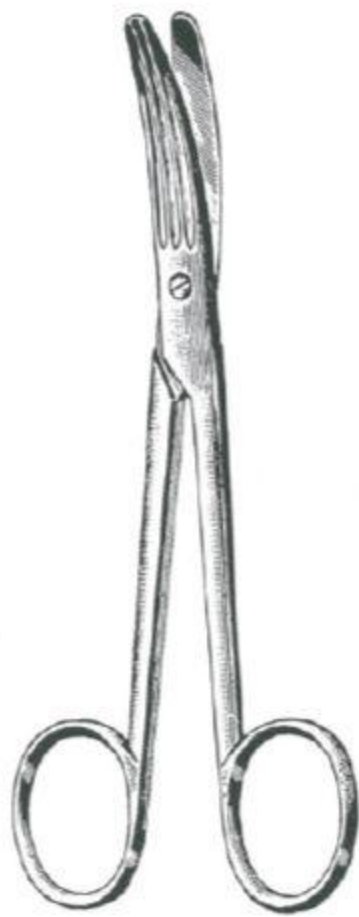

SCHOEMAKER
22-5601-15 15.0cm

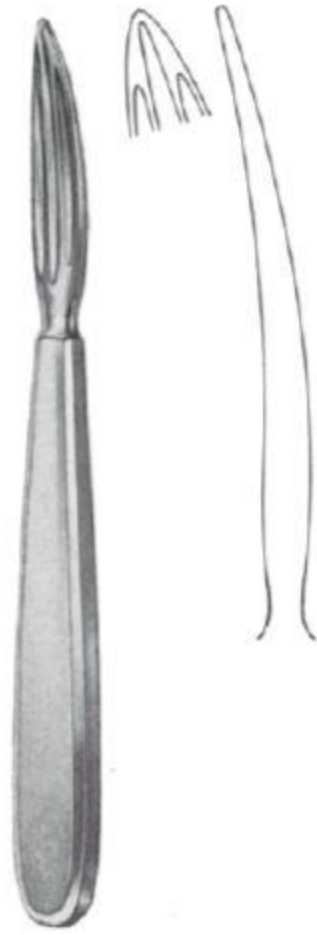

KOCHER
22-5602-15 15.0cm
22-5602-16 16.0cm

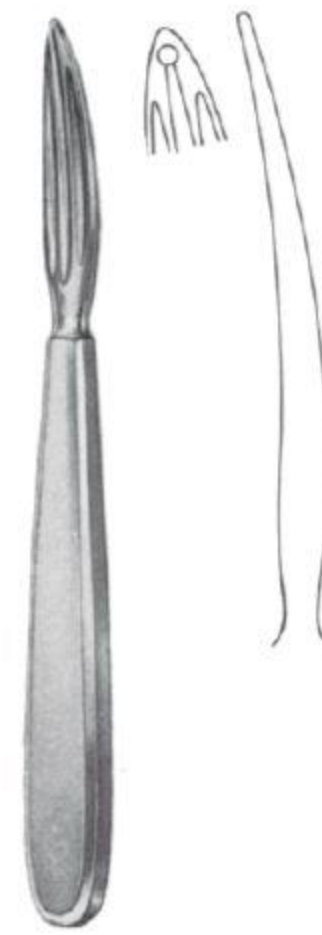

KOCHER
22-5603-15 15.0cm
22-5603-16 16.0cm

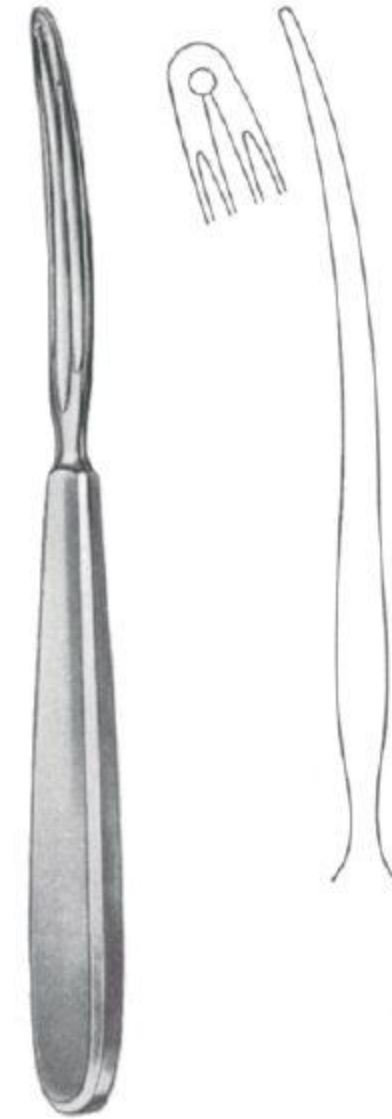

KOCHER
22-5604-18 18.0cm



HOFMEISTER
22-5605-21 21.0cm



LAHEY
22-5606-15 15.0cm
22-5606-20 20.0cm

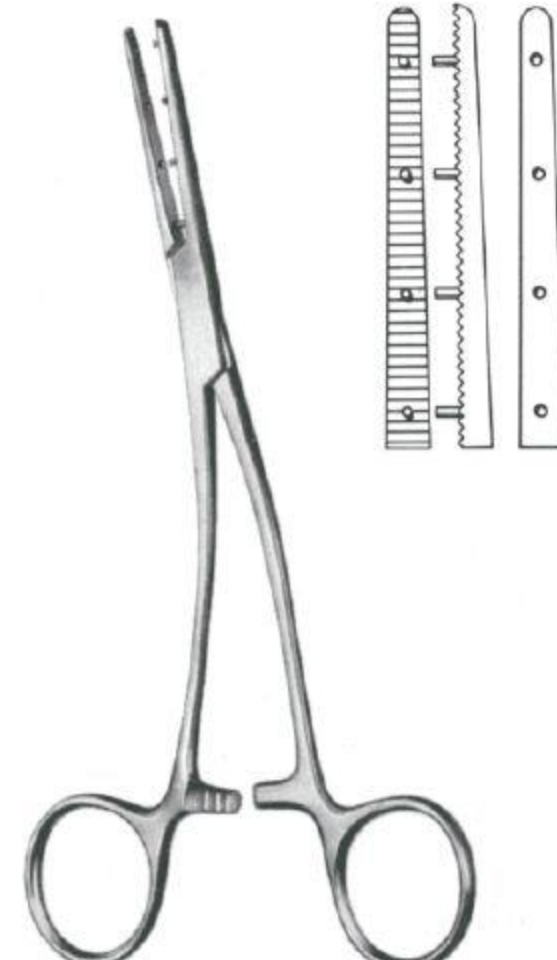

MASTIN
22-5607-17 17.0cm

- EN** Dermatology
- DE** Dermatologie
- ES** Dermatología

Page 481 to 482



Comedone Extractors



Schamberg
23-5751-10
10 cm/4"



Unna
23-5752-14
14 cm/5½"



Unna
23-5753-14
14 cm/5½"



Sealfeld
23-5754-10
10 cm/4"



Saalfeld
23-5755-14
14 cm/5½"



Katsch
23-5756-14
14 cm/5½"



Hebra
23-5757-18
18 cm/7"

Skin Curettes



Piffard
14.5cm/5¾"



Fig. 1 23-5758-01



Fig. 2 23-5758-02



Fig. 3 23-5758-03

Lupus Currettes, Scraper, Moncorps Knife and Cutaneous Hooks ●— EN

Lupus Küretten, Schaber, Messer und Moncorps Kutane Hooks ●— DE

Curetas lupus, raspador, cuchillos y ganchos Moncorps cutánea ●— ES

Lupus Currettes

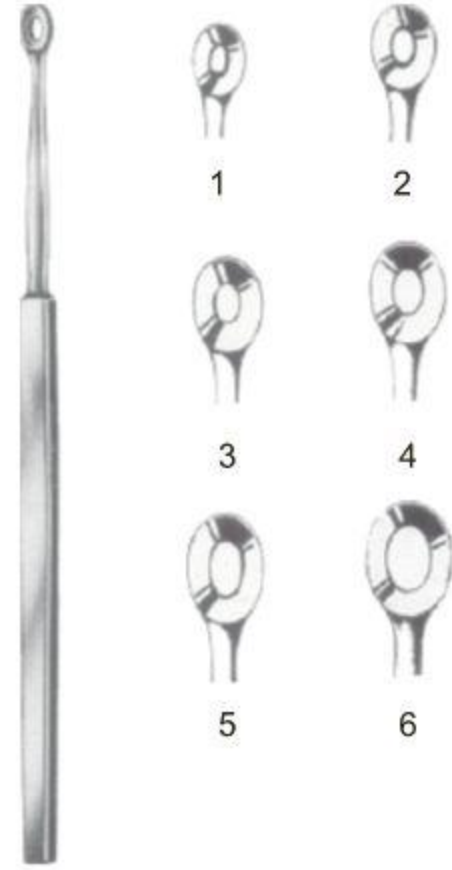

- Fig.
1 23-5759-01
2 23-5759-02
3 23-5759-03
4 23-5759-04
5 23-5759-05
6 23-5759-06

Wolff
14 cm/5½"

Lupus Currettes

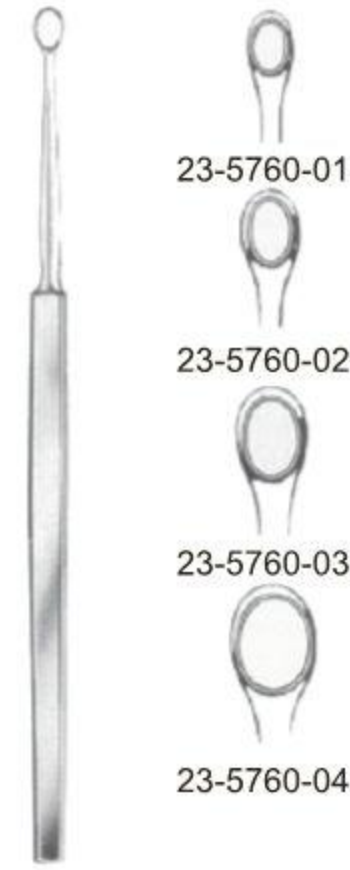

Fox
14 cm/5½"

Lupus Scraper



Vidal
23-5761-14
14 cm/5½"

Moncorps Knife



Moncorps
23-5762-14
14 cm/5½"



- Fig. 1
Fig. 2

Gillies
Fig. 1 23-5763-01
Fig. 2 23-5763-02
18 cm/7"

Cutaneous Hook



Kilner
23-5764-15
15 cm/6"

- EN** Stomach, Intestine, Rectum
DE Magen, Darm, Mastdarm
ES Estómago, Intestinos, Recto

Page 483 to 504



EN —● Tissue Seizing and Intestinal Atrauma Tissue Forceps
 DE —● Tissue Beschlagnahme und Darm Atrauma Tissue Zange
 ES —● Aprovechando el tejido intestinal y pinzas de tejido Atrauma



		Allis	
cm	in	4 : 5	5 : 6
15	6"	24-5801-15	24-5802-15
19	7½"		24-5802-19
23	9"		24-5802-23
25	10"		24-5802-25



		Baby-Allis	
24-5803-12	12 cm/4¾"		
24-5803-14	14 cm/5½"		



		Allis-Atrauma	
24-5804-16	16 cm/6¼"		
24-5804-20	20 cm/8"		
24-5804-25	25 cm/10"		
24-5804-30	30 cm/12"		



Allis-Adair
24-5805-15
15 cm/6"



Baby-Allis
24-5806-15
15 cm/6"



Lockwood-Allis
24-5807-16 16 cm/6¼"
24-5807-20 20 cm/8"



Thoms-Allis
24-5808-20
20 cm/8"

Tissue Seizing and Intestinal Atrauma Tissue Forceps ● EN
 Tissue Beschlagnahme und Darm Atrauma Tissue Zange ● DE
 Aprovechando el tejido intestinal y pinzas de tejido Atrauma ● ES

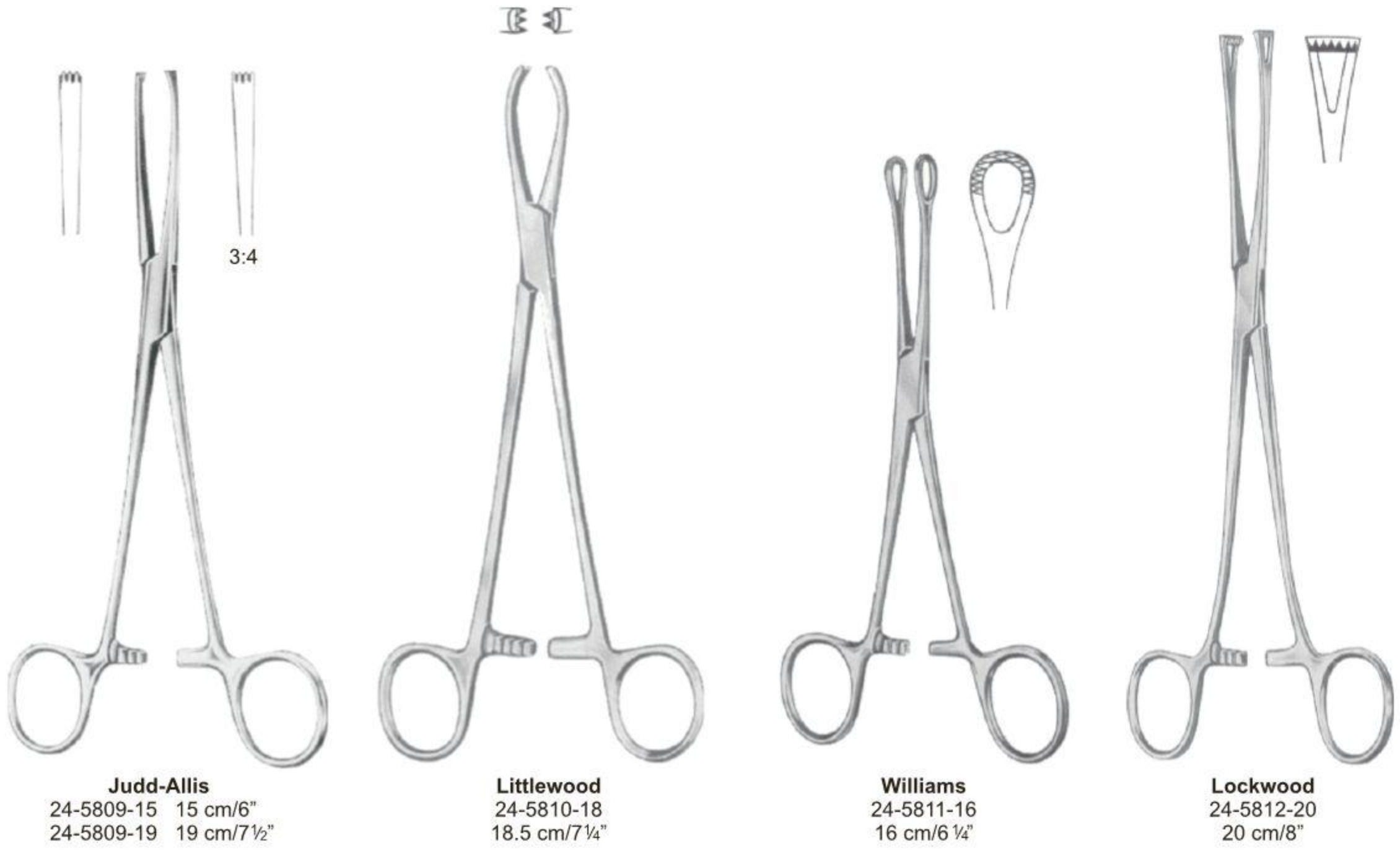

Judd-Allis
 24-5809-15 15 cm/6"
 24-5809-19 19 cm/7½"

Littlewood
 24-5810-18
 18.5 cm/7¼"

Williams
 24-5811-16
 16 cm/6¼"

Lockwood
 24-5812-20
 20 cm/8"

Atrauma



cm/in	Babcock-Atrauma	Babcock(Standard)	Baby-Babcock	Babcock
16 cm/6¼"	24-5813-16	24-5814-16	24-5815-16	24-5816-16
18 cm/7"		24-5814-18		
20 cm/8"	24-5813-20	24-5814-20		24-5816-20
24 cm/9½"		24-5814-24		

EN —● Intestinal Tissue and Organ Grasping Forceps
DE —● Gewebe- und organ-Faßzangen
ES —● Pinzas para tejidos y órganos

Atrauma

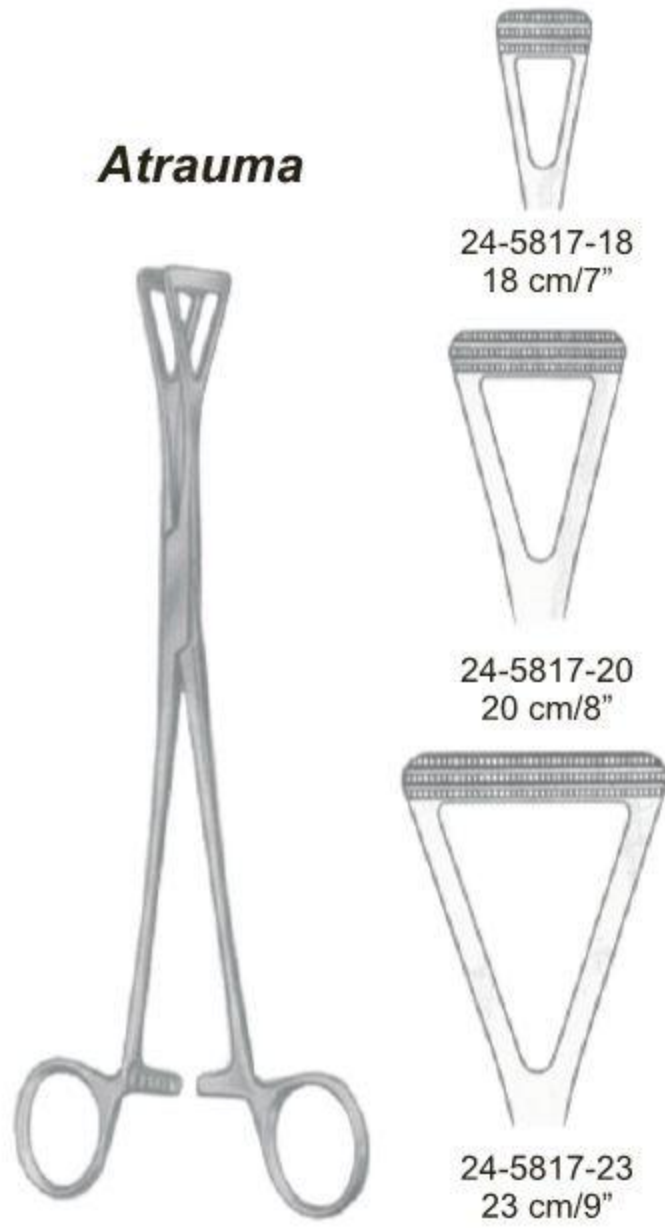

		Duval			
		cm	in		
24-5818-18		18	7"		
24-5818-20		20	8"	24-5819-20	
24-5818-23		23	9"	24-5819-23	

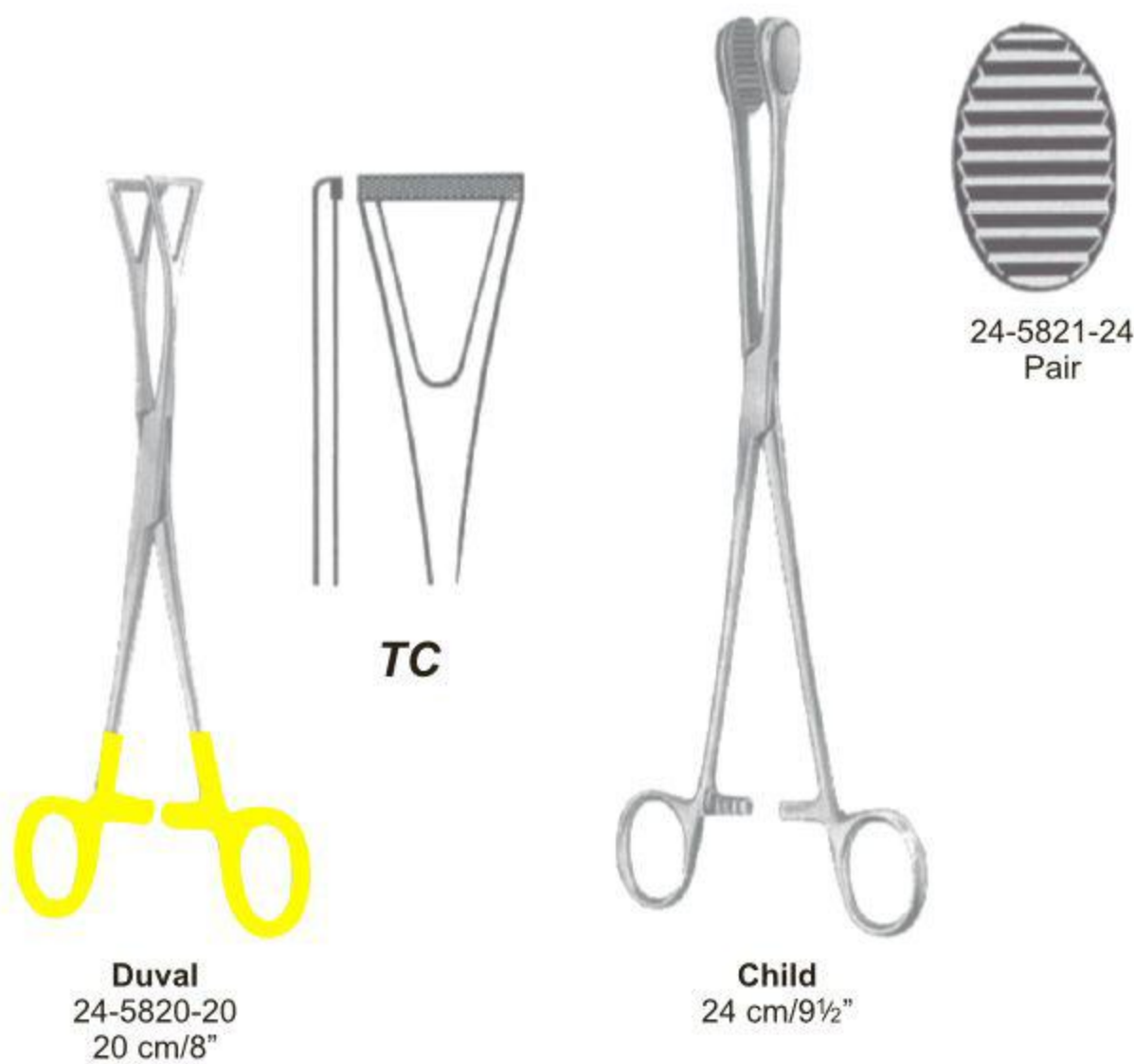

Atrauma

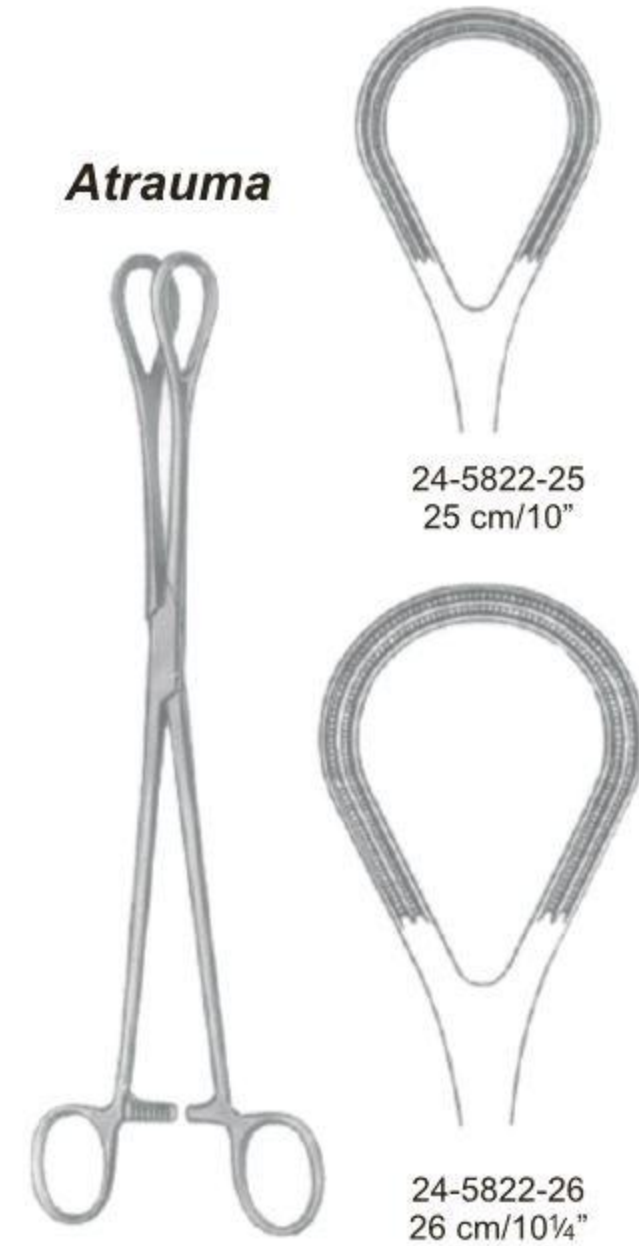

Intestinal Clamps Forceps ●— EN
 Darmklemmen ●— DE
 Pinzas-clamps intestinales ●— ES



Baby-Doyen
 Straight 24-5823-18 18 cm/7"
 Curved 24-5824-18 18 cm/7"

Doyen
 Straight 24-5825-21 21 cm/8 1/4
 24-5825-23 23 cm/9"
 Curved 24-5826-21 21 cm/8 1/4
 24-5826-23 23 cm/9"

Scudder
 24-5827-25 25 cm/10"



Doyen-Atrauma

Atrauma

Straight



Atrauma

Curved

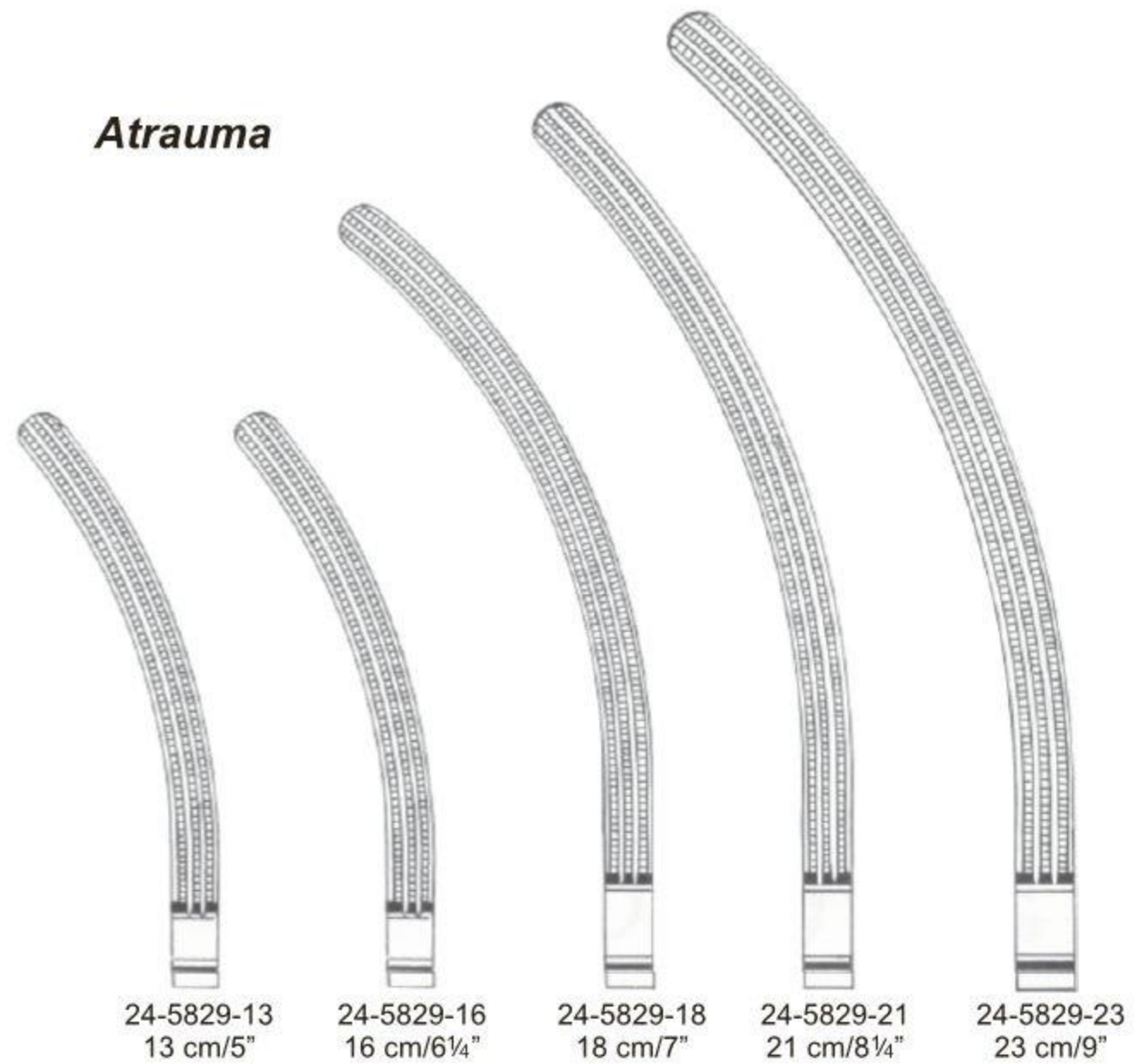

Intestinal Clamps Forceps ●— EN
 Darmklemmen ●— DE
 Pinzas-clamps intestinales ●— ES



Mayo-Robson
 Mayo-Robson Atrauma

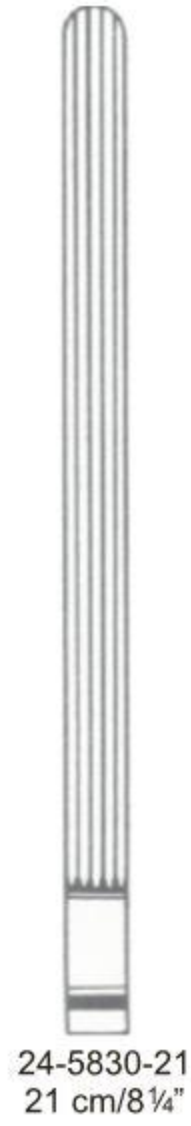

24-5830-21
 21 cm/8 1/4"



24-5831-21
 21 cm/8 1/4"

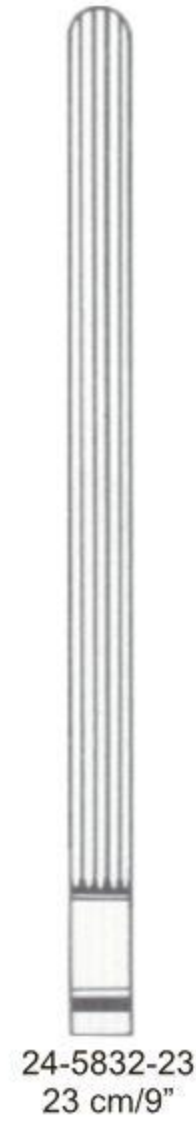

24-5832-23
 23 cm/9"



24-5833-23
 23 cm/9"

Atrauma



24-5834-25
 25 cm/10"



24-5835-25
 25 cm/10"



24-5836-25
 25 cm/10"



24-5837-25
 25 cm/10"



Resano
24-5838-30
30 cm/12"



Hayes



24-5839-26
26 cm/10 1/4"

Atrauma

Atrauma



24-5840-28
28 cm/11"



Fehland
24-5841-24
24 cm/9 1/2"



Brunner
24 cm/9 1/2"



24-5842-24



24-5843-24

Intestinal Clamps Forceps ●— EN
 Darmklemmen ●— DE
 Pinzas-clamps intestinales ●— ES



Baby-Kocher
 Straight 24-5844-13 13 cm/5"
 Curved 24-5845-13 13 cm/5"



Kocher



24-5846-22
 22 cm/8¾"



24-5846-25
 25 cm/10"



24-5846-28
 28 cm/11"



24-5847-22
 22 cm/8¾"



24-5847-25
 25 cm/10"



24-5847-28
 28 cm/11"

Atrauma



Kocher-Atrauma



24-5848-22
22 cm/8 3/4"



24-5848-25
25 cm/10"



24-5848-28
28 cm/11"



24-5849-22
22 cm/8 3/4"



24-5849-25
25 cm/10"



24-5849-28
28 cm/11"

Intestinal Clamps Forceps ●— EN
 Darmklemmen ●— DE
 Pinzas-clamps intestinales ●— ES

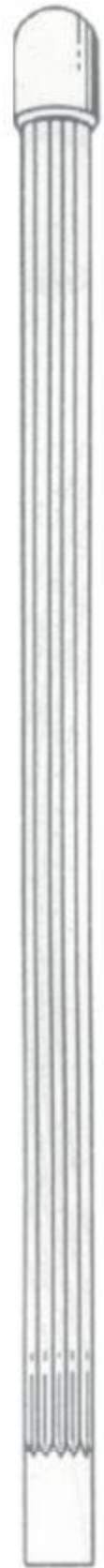

Straight
 24-5851-25



Nussbaum
 25 cm/10"

Curved
 24-5852-25



Pylorus spreader

Benson
 24-5850-15
 15.5 cm/6"

Blindgut forceps



Allen
 24-5853-15 15.5 cm/6"
 24-5853-20 20.0 cm/8"



Kleinschmidt
 24-5854-12
 12 cm/4¾"



Payr
(Payr-Baby)

For children



24-5855-15
15 cm/6"

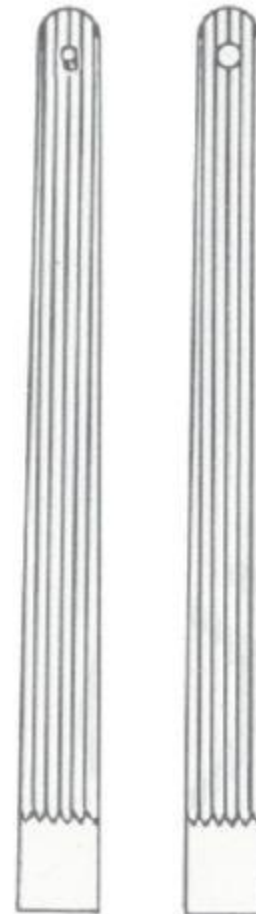

24-5856-21
21 cm/8¼"

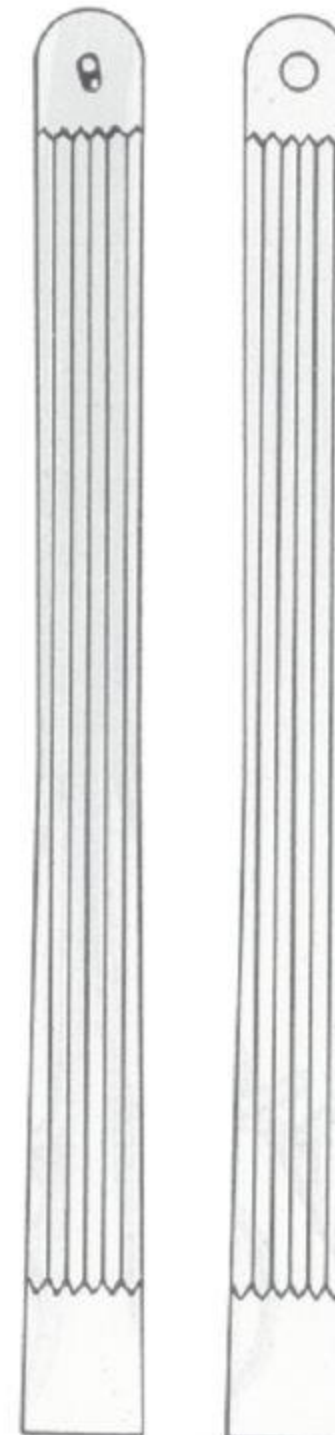

24-5857-29
29 cm/11½"

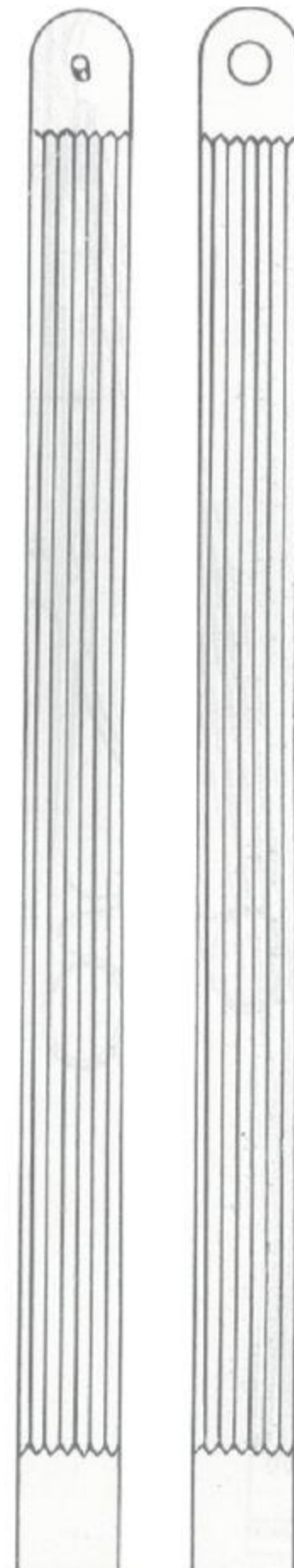

24-5858-35
35 cm/13¾"



Lane
 30 cm/12"

Twin Clamps Forceps



Straight
 24-5859-30

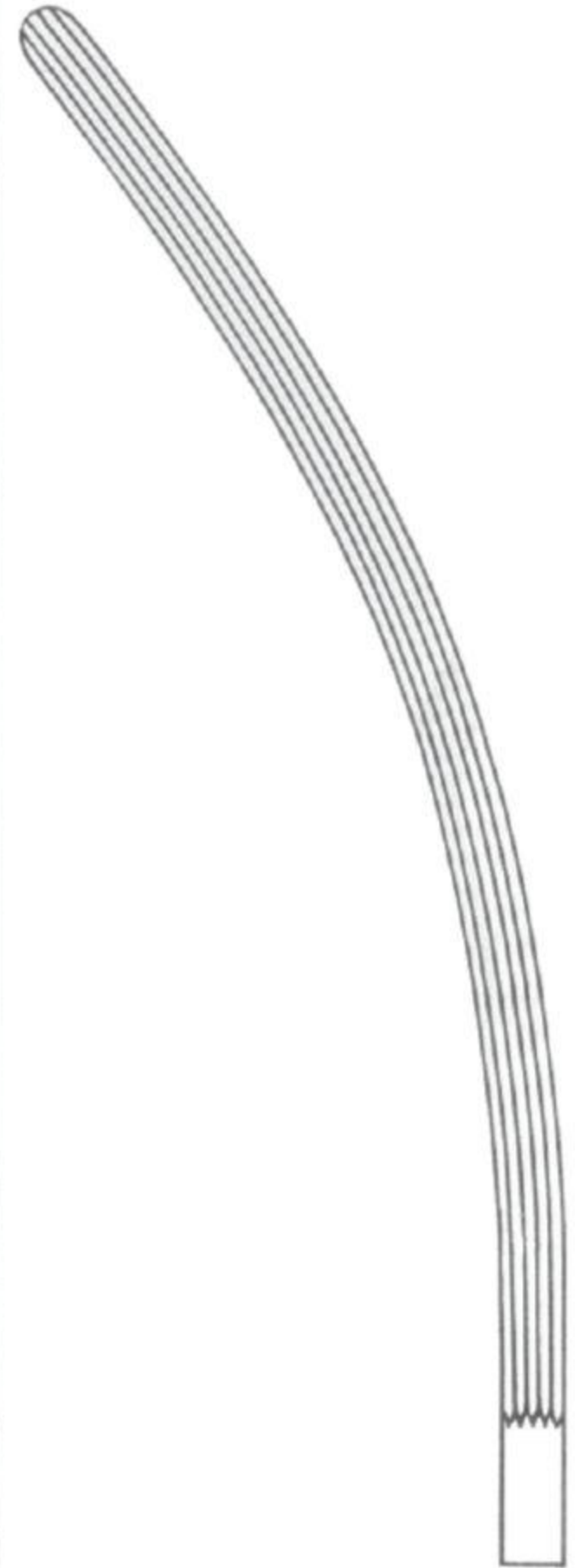

Curved
 24-5860-30

Atrauma



Stomach Clamps Forceps ●— EN
 Magenklappen ●— DE
 Pinzas-clamps estomacales ●— ES

Intestinal and Stomach Twin Clamps



Haberer
 24-5865-36
 36 cm/14"



Straight
 24-5866-30

Nussbaum
 30 cm/12"

Curved
 24-5867-30



Czerny
24-5868-22
22 cm/8¾"



Pratt
24-5869-20
80 x 25 mm
20.5 cm/8"



Sims
25-08291-15

(Bodenhammer) Sims
24-5870-15
15 cm/6"



Sims
22 cm/8¾"



Mathieu
24-5872-19
90 x 15 mm
19.5 cm/7¾"

Length of Blades
24-5871-06
24-5871-08
24-5871-12
24-5871-15

60 mm
80 mm
125 mm
150 mm

Rectal Speculas, Anal Retractors, Anusscopes ●— EN

Mastdarm-spekula, -spreizer, Anoskop ●— DE

Espéculos rectales, Anoscopio ●— ES



Barr
24-5873-17
17 cm/6¾"
70 X 22 mm

Anal Retractors



Smith-Bule
24-5874-15
15 cm/6"

Anusscopes



Hirschmann
Fig. 1 16 mm Ø x 65 mm 24-5875-01
Fig. 2 19 mm Ø x 65 mm 24-5875-02
Fig. 3 22 mm Ø x 65 mm 24-5875-03
Fig. 4 25 mm Ø x 65 mm 24-5875-04



Bensaude
Fig. 1 19 mm Ø x 70 mm 24-5876-01
Fig. 2 22 mm Ø x 70 mm 24-5876-02

EN —● Anusopes, Proctoscopes and Sphincteroscopes

DE —● Spinkteroskope, Anuskope, Proktoskope

ES —● Esfinteroscopios, Anoscopios, Proctoscopios

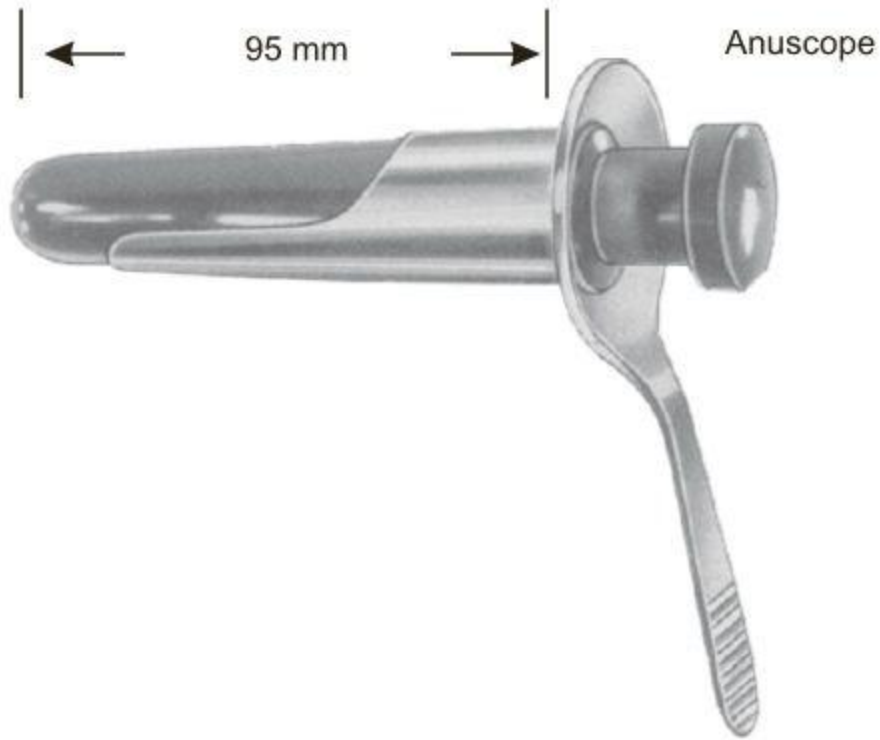

Ives-Fansler
24-5877-22
22 mm Ø

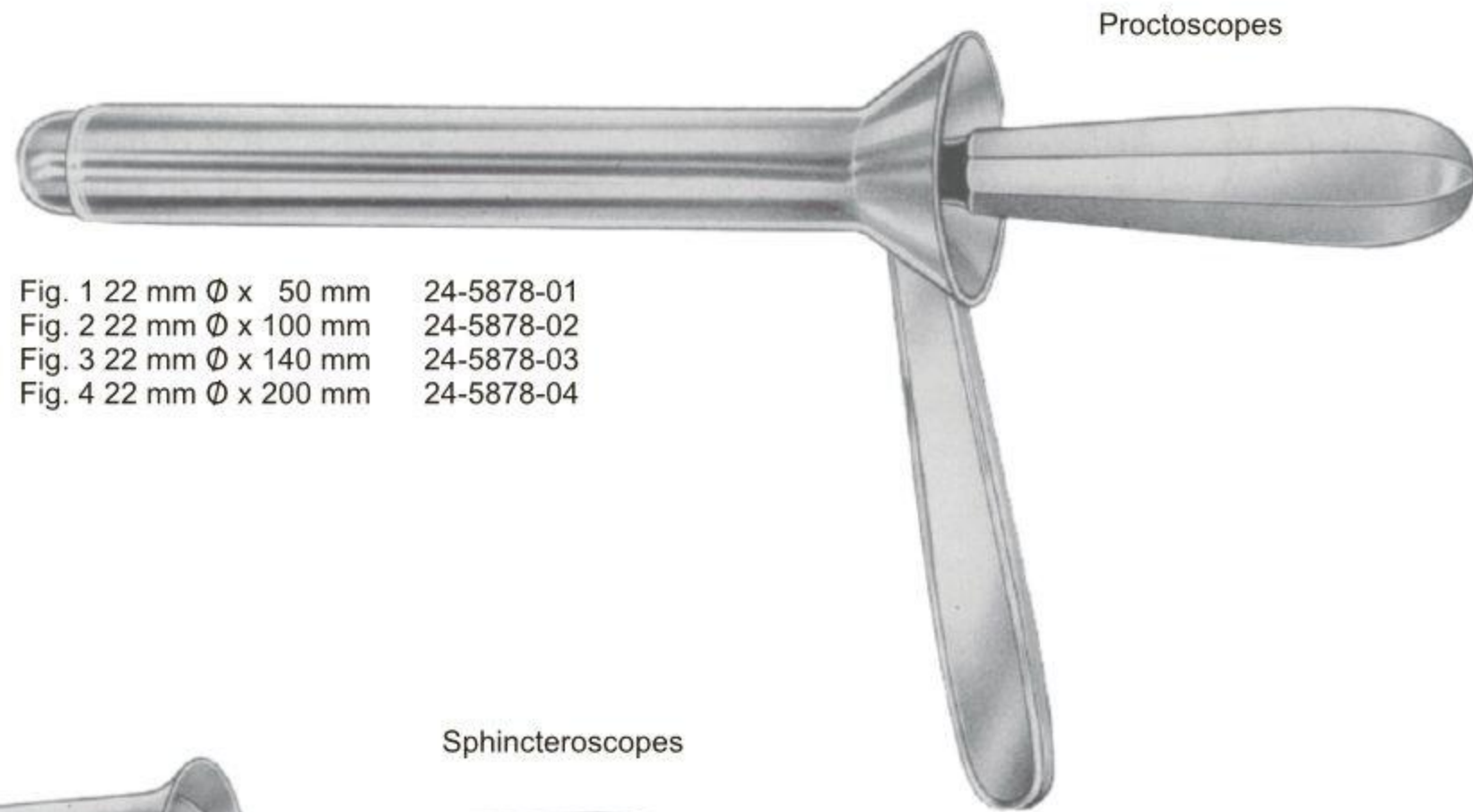

Fig. 1 22 mm Ø x 50 mm	24-5878-01
Fig. 2 22 mm Ø x 100 mm	24-5878-02
Fig. 3 22 mm Ø x 140 mm	24-5878-03
Fig. 4 22 mm Ø x 200 mm	24-5878-04

Kelly



Kelly

Fig. 1 21 mm Ø 50 mm	24-5879-01
Fig. 2 27 mm Ø 50 mm	24-5879-02

Anal Retractors ●— EN
 Spreizer ●— DE
 Espéculos rectales ●— ES

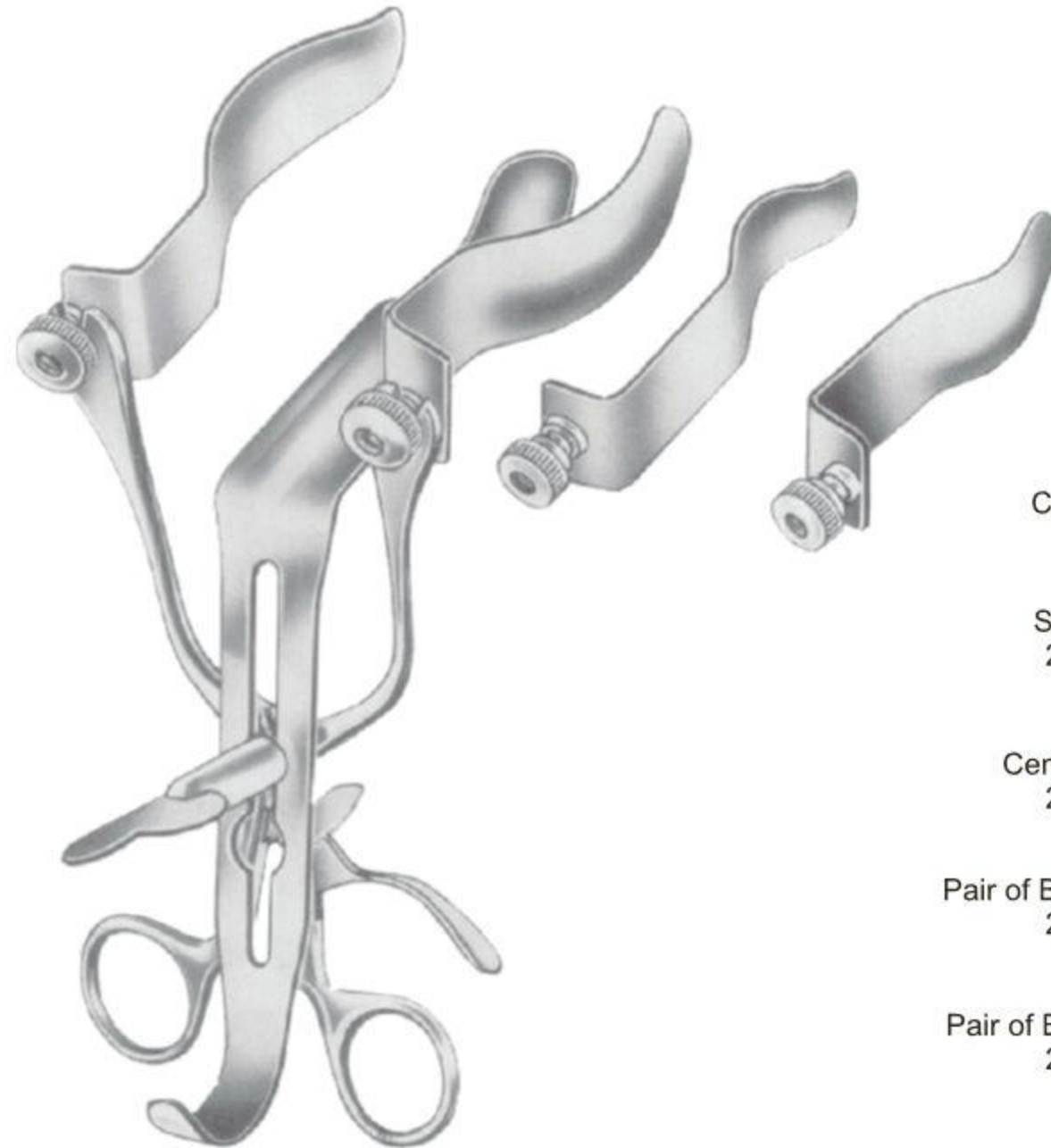

Consisting of:

Spreader only
24-5880-01

Center Blade only
24-5880-02

Pair of Blades Only 75 mm
24-5880-03

Pair of Blades only 95 mm
24-5880-04

Park
24-5880-00
14.5 cm/5¾"



Consisting of:

Spreader only
24-5881-01

Pair of Blades only 95 mm
24-5881-02

Park
24-5881-00
13 cm/5"

Length of Shaft

				cm	in	Yeoman
1	2	3	4	28	11	
24-5882-28	24-5883-28	24-5884-28	24-5885-28	35	13¾"	
24-5882-35	24-5883-35	24-5884-35	24-5885-35	42	16½"	
24-5882-42	24-5883-42	24-5884-42	24-5885-42			

Length of Shaft

Turnable

Length of Shaft	Length of Shaft		Forceps Complete	Attachment Only
	cm	in		
	33	13	24-5886-33	24-5890-33
	40	16	24-5886-40	24-5890-40
	33	13	24-5887-33	24-5891-33
	40	16	24-5887-40	24-5891-40
	33	13	24-5888-33	24-5892-33
	40	16	24-5888-40	24-5892-40
	33	13	24-5889-33	24-5893-33
	40	16	24-5889-40	24-5893-40

Yeoman (Turrell)
Handle Only
24-5894-00



Heywood-Smith
24-5895-21
21 cm/8¼"



Heywood-Smith
24-5896-21
21 cm/8¼"

Rectal Snare

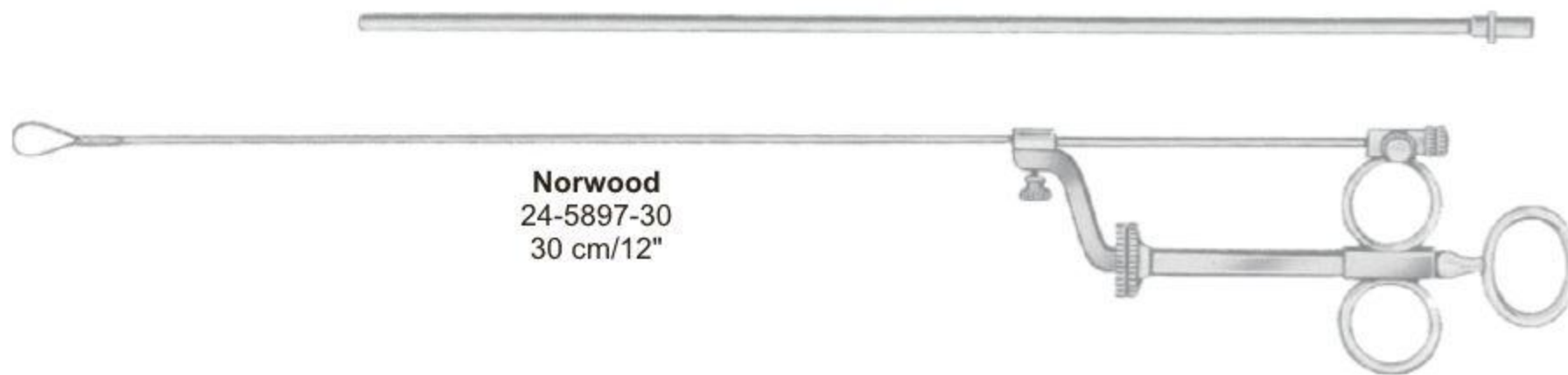

Norwood
24-5897-30
30 cm/12"

Rectal Aspiration Cannula

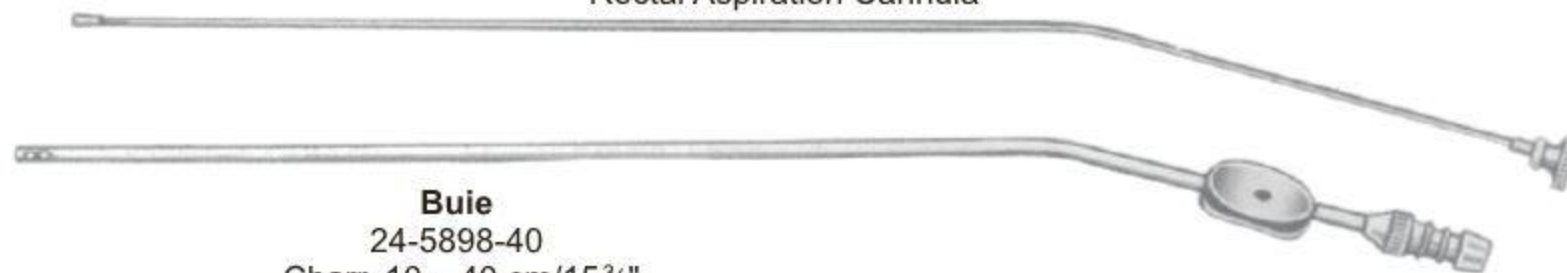

Buie
24-5898-40
Charr. 10. 40 cm/15¾"

Rectal Coolers



24-5899-01



24-5900-02

Aspiration Tip

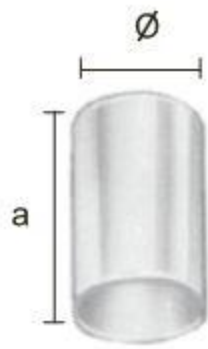

	a	∅
24-5901-11	11 mm	10 mm
24-5901-16	16 mm	10 mm

Charging Cone



10 mm ∅

24-5902-10

Charging Cone



12 mm ∅

24-5903-12

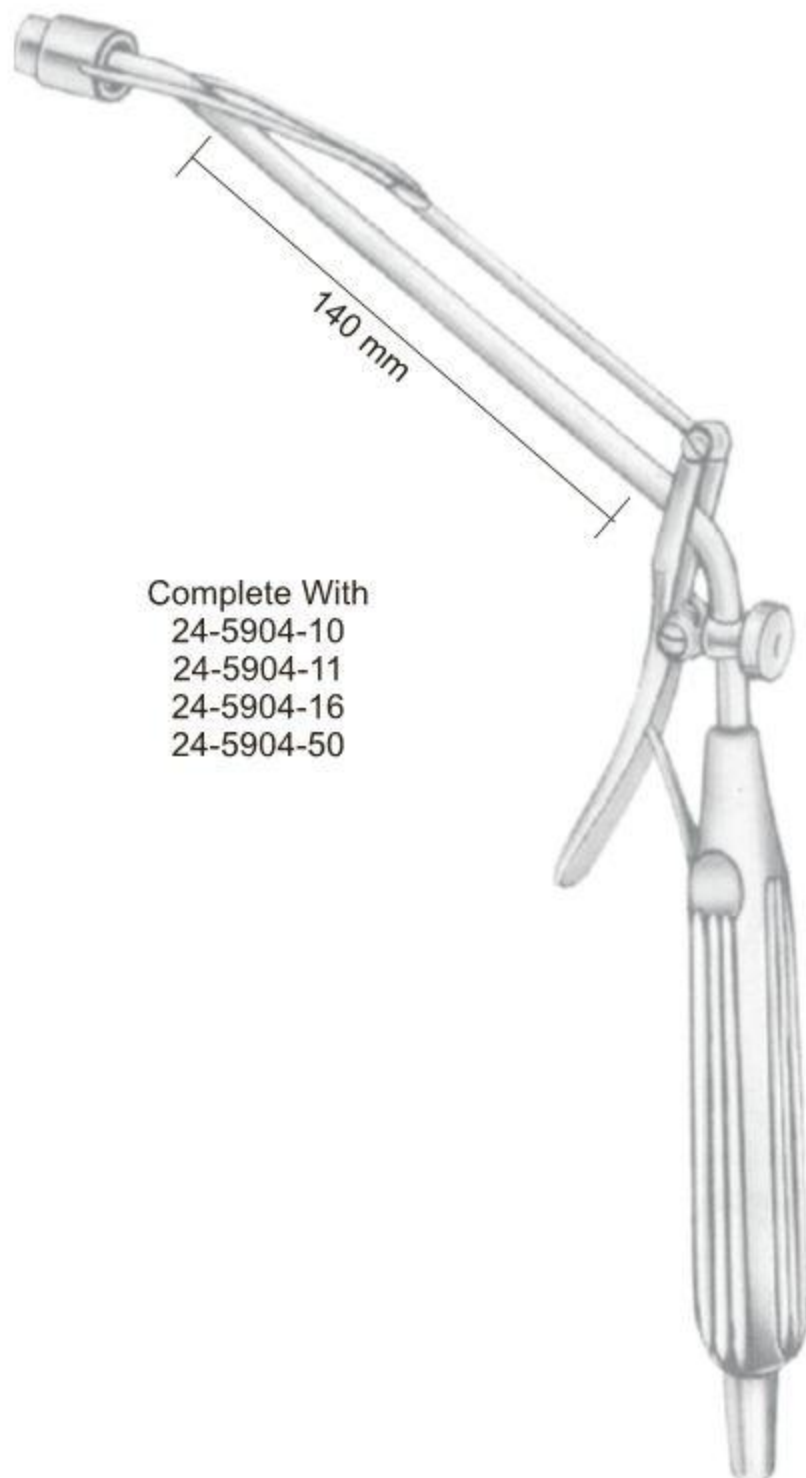

Complete With
24-5904-10
24-5904-11
24-5904-16
24-5904-50

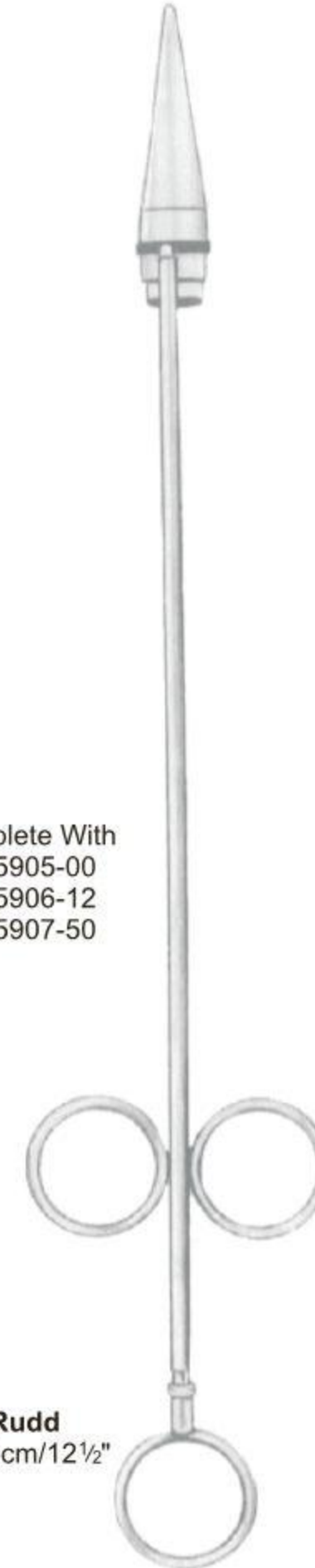

Complete With
24-5905-00
24-5906-12
24-5907-50

Rudd
31.5 cm/12½"

Haemorrhoidal Ligators ●— EN
 Haemorrhoidal Ligators ●— DE
 Ligators Haemorrhoidal ●— ES

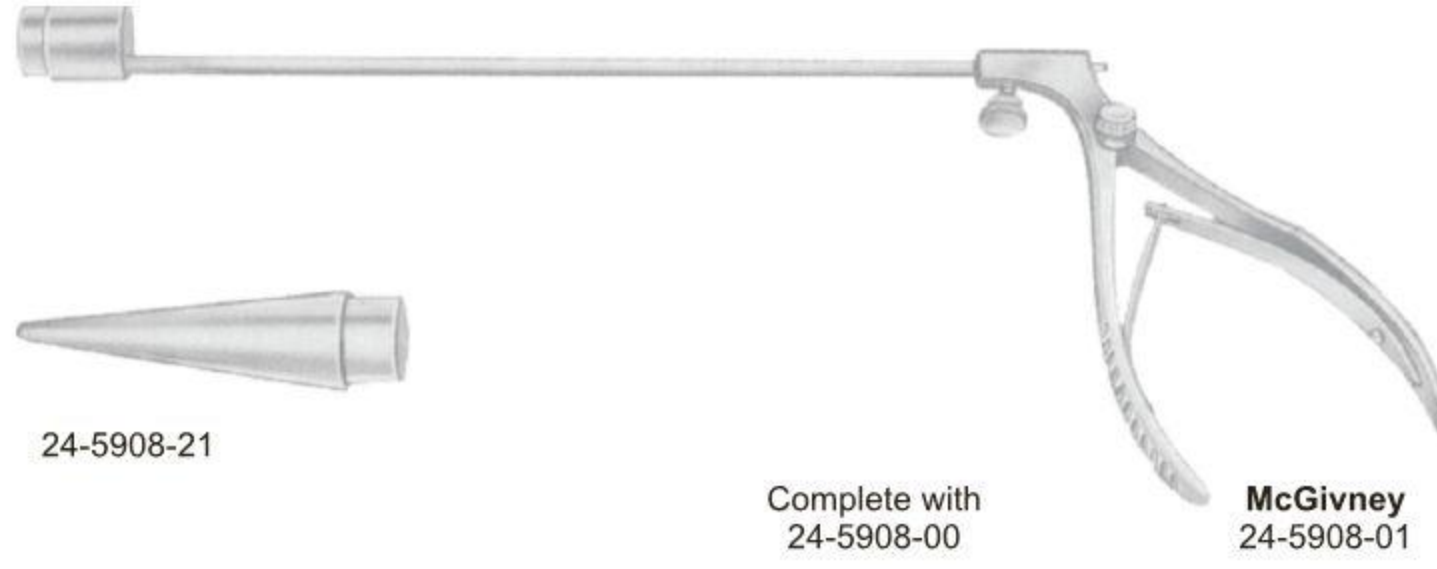

24-5908-21

Complete with
24-5908-00

McGivney
24-5908-01



Complete with
24-5909-00

Ford Dixon
24-5909-01

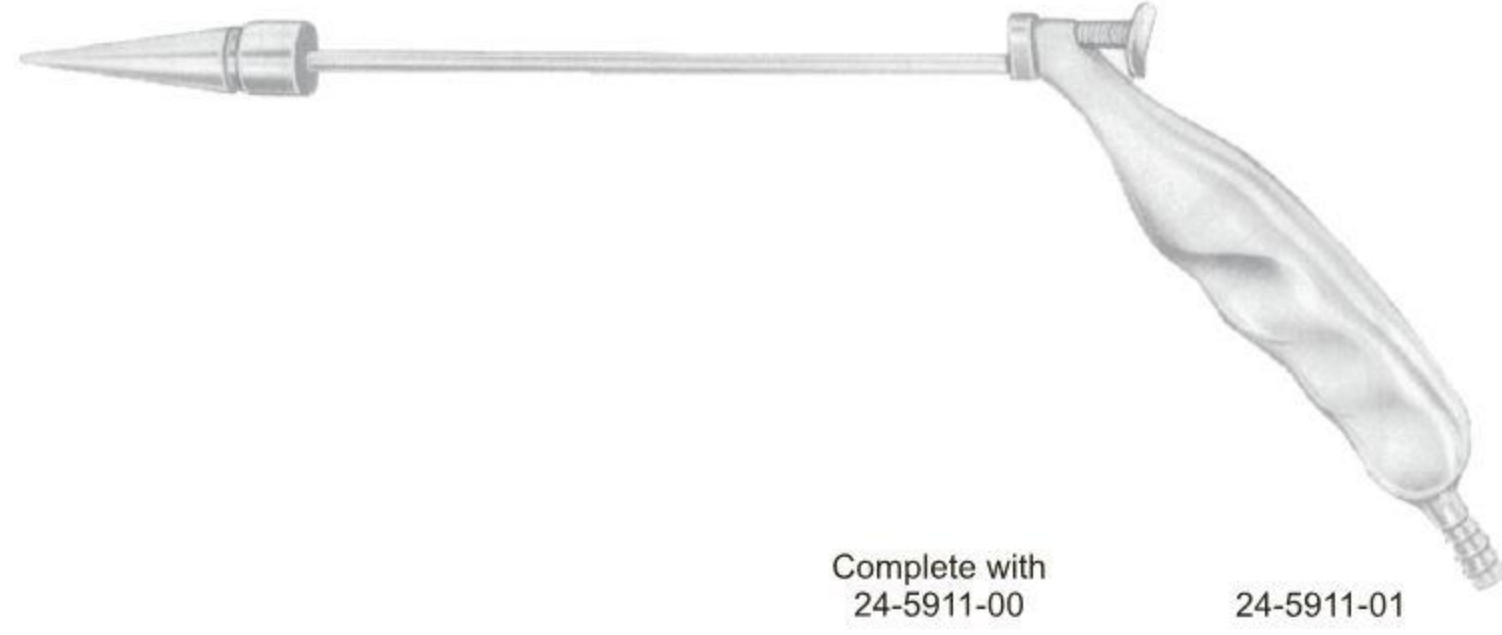

Complete with
24-5911-00

24-5911-01



McGivney
24-5910-19
19 cm/7 1/2"



24-5912-00
Ligator rubber rings
in box of 100 pieces

- EN** Kidney, Liver, Gall Stone, Urology
- DE** Niere, Leber, Galle, Urologie
- ES** Riñón, Hígado, Bilis, Urología

Page 505 to 518



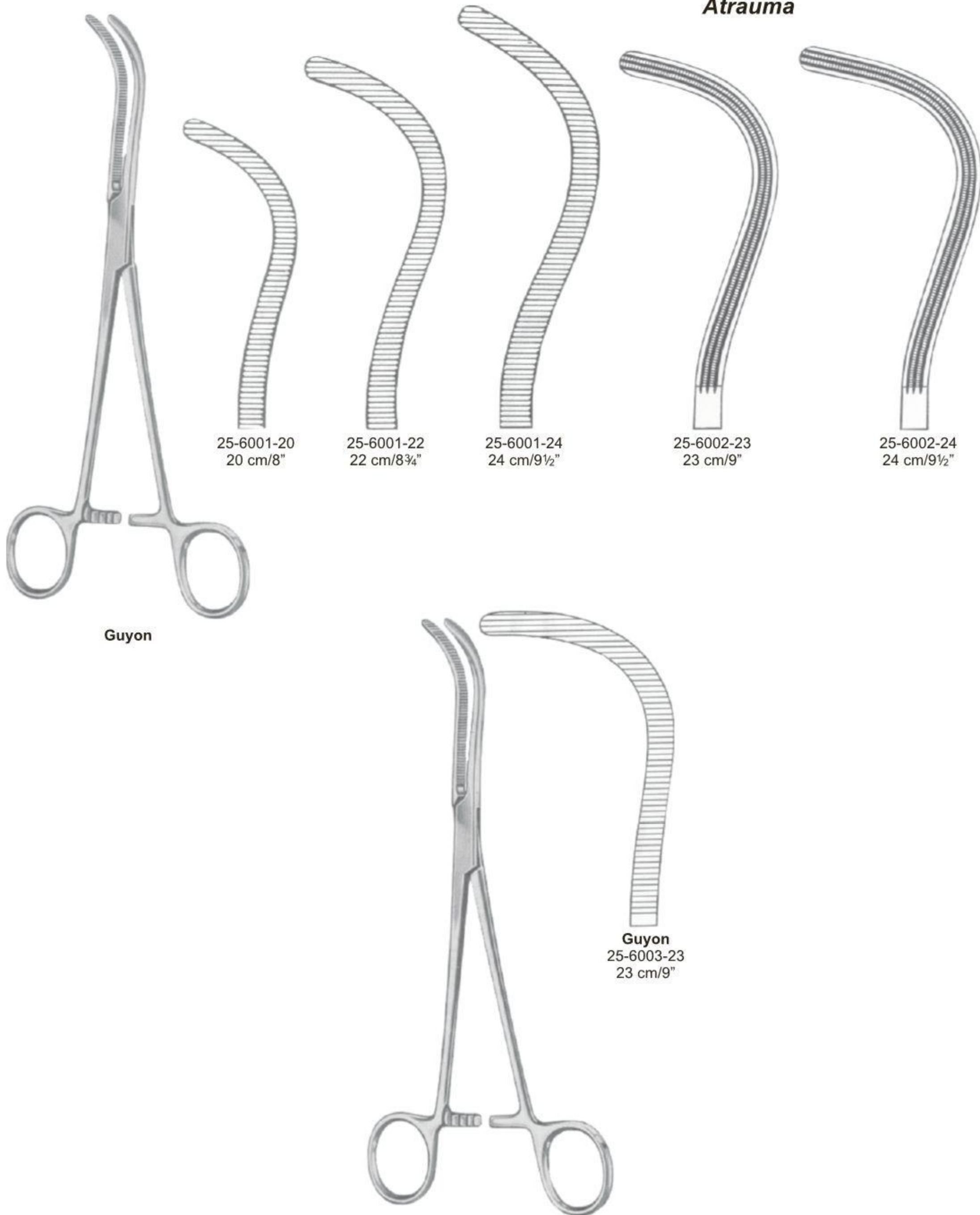

Kidney Pedicle Clamp Forceps ●— EN
 Kidney Gestielte Klammerzange ●— DE
 Pinzas de riñón Clamp pediculares ●— ES



Herrick
 25-6004-23
 23 cm/9"



Mayo-Guyon
 25-6005-23
 23 cm/9"



Stille
 25-6006-23
 23 cm/9"



Elsasser
25-6007-20
20 cm/8"



25-6008-20
20 cm/8"

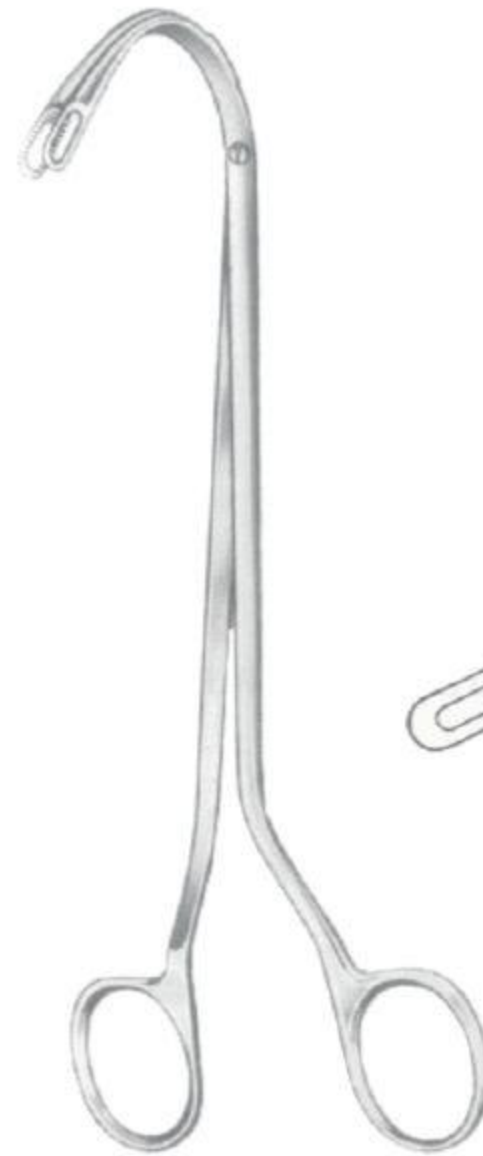

Randall

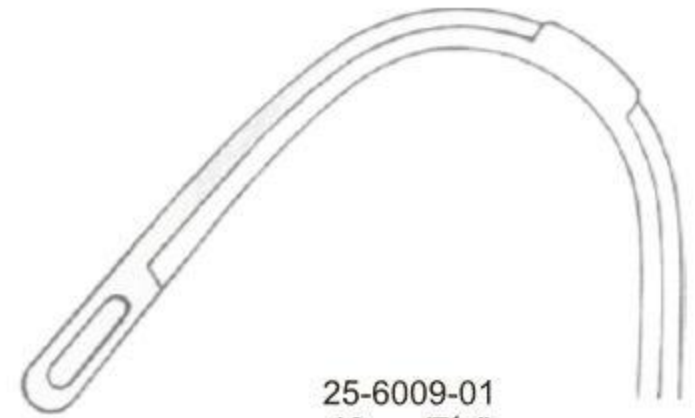

25-6009-01
19 cm/7½"

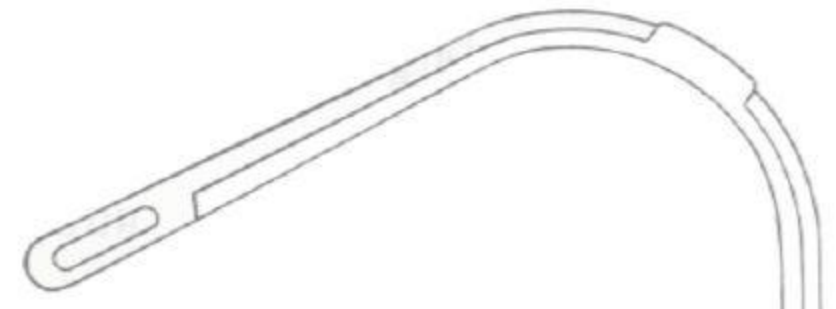

25-6009-02
19 cm/7½"



Randall

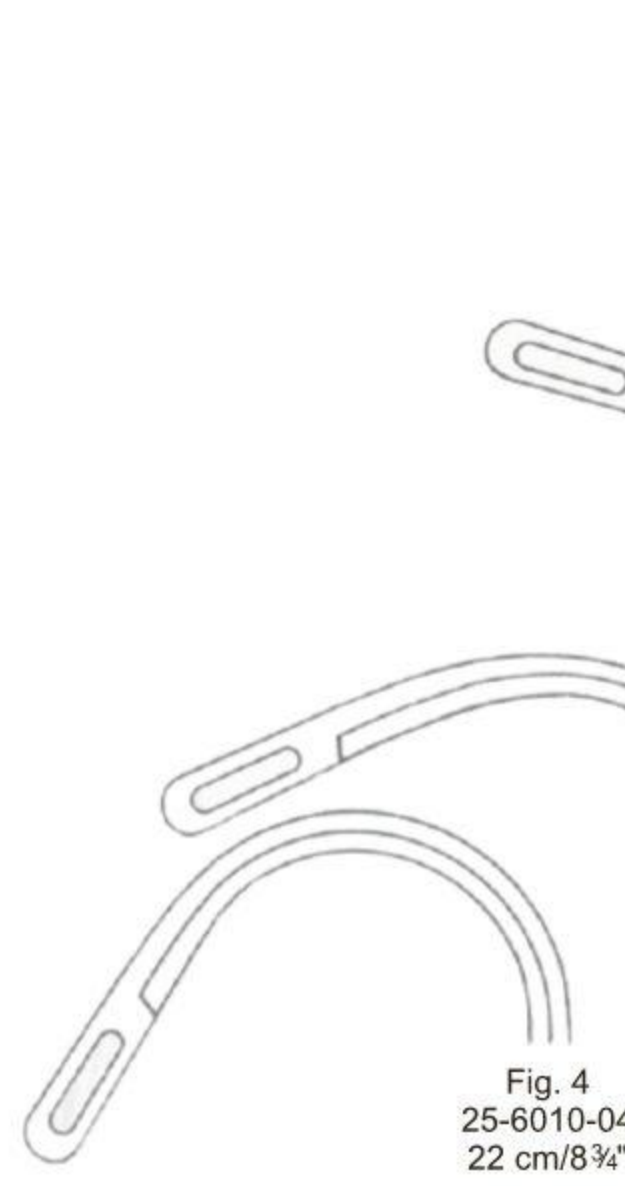

Fig. 4
25-6010-04
22 cm/8¾"



Fig. 3
25-6010-03
22 cm/8¾"



Fig. 2
25-6010-02
22 cm/8¾"



Fig. 1
25-6010-01
23 cm/9"

Gall Duct Forceps ●— EN
 Gall Duct Zange ●— DE
 Pinzas conducto biliar ●— ES



Gray
 25-6011-00

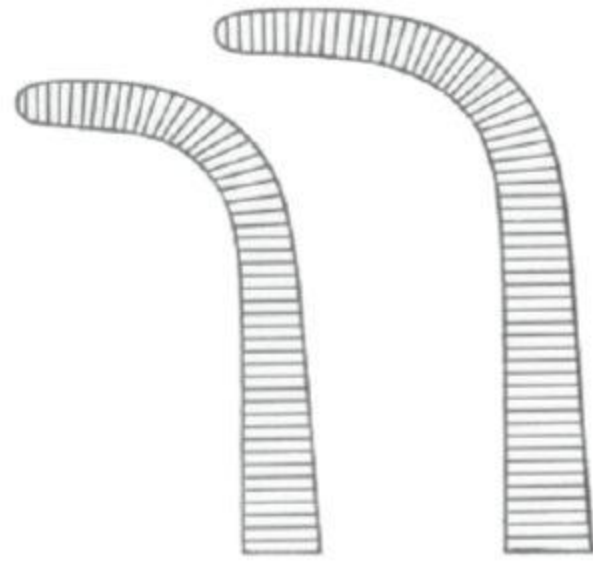

Fig. 1
 25-6011-01
 22 cm/8¾"

Fig. 2
 25-6011-02
 23 cm/9"

Set of 2 pieces



Gray
 25-6012-00



Fig. 1
 25-6012-01
 22 cm/8¾"

Fig. 2
 25-6012-02
 23 cm/9"

Set of 2 pieces



Gall duct and
 cystic forceps

Desjardins
 25-6013-21
 21 cm/8¼"



Nissen
 25-6014-21
 21.5 cm/8½"



Straight **Blake** Curved
25-6015-20 20 cm/8" 25-6016-20



Straight **Mayo-Blake** Curved
25-6017-20 20 cm/8" 25-6018-20



Czerny
25-6019-24
24.5 cm/9¾"



Desjardins
23 cm/9"

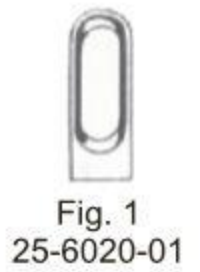
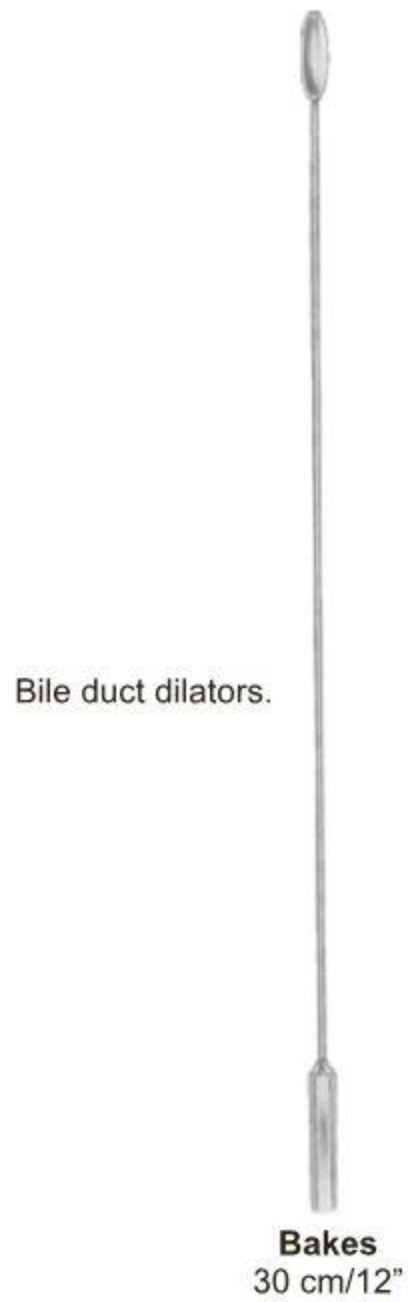

Fig. 1
25-6020-01



Fig. 2
25-6021-02



mm	
1	25-6025-01
2	25-6025-02
3	25-6025-03
4	25-6025-04
5	25-6025-05
6	25-6025-06
7	25-6025-07
8	25-6025-08
9	25-6025-09
10	25-6025-10
11	25-6025-11
12	25-6025-12
13	25-6025-13

25-6025-00
set of 9 pieces

25-6025-03 to 25-6025-11

25-6026-00
set of 9 pieces in canvas pocket

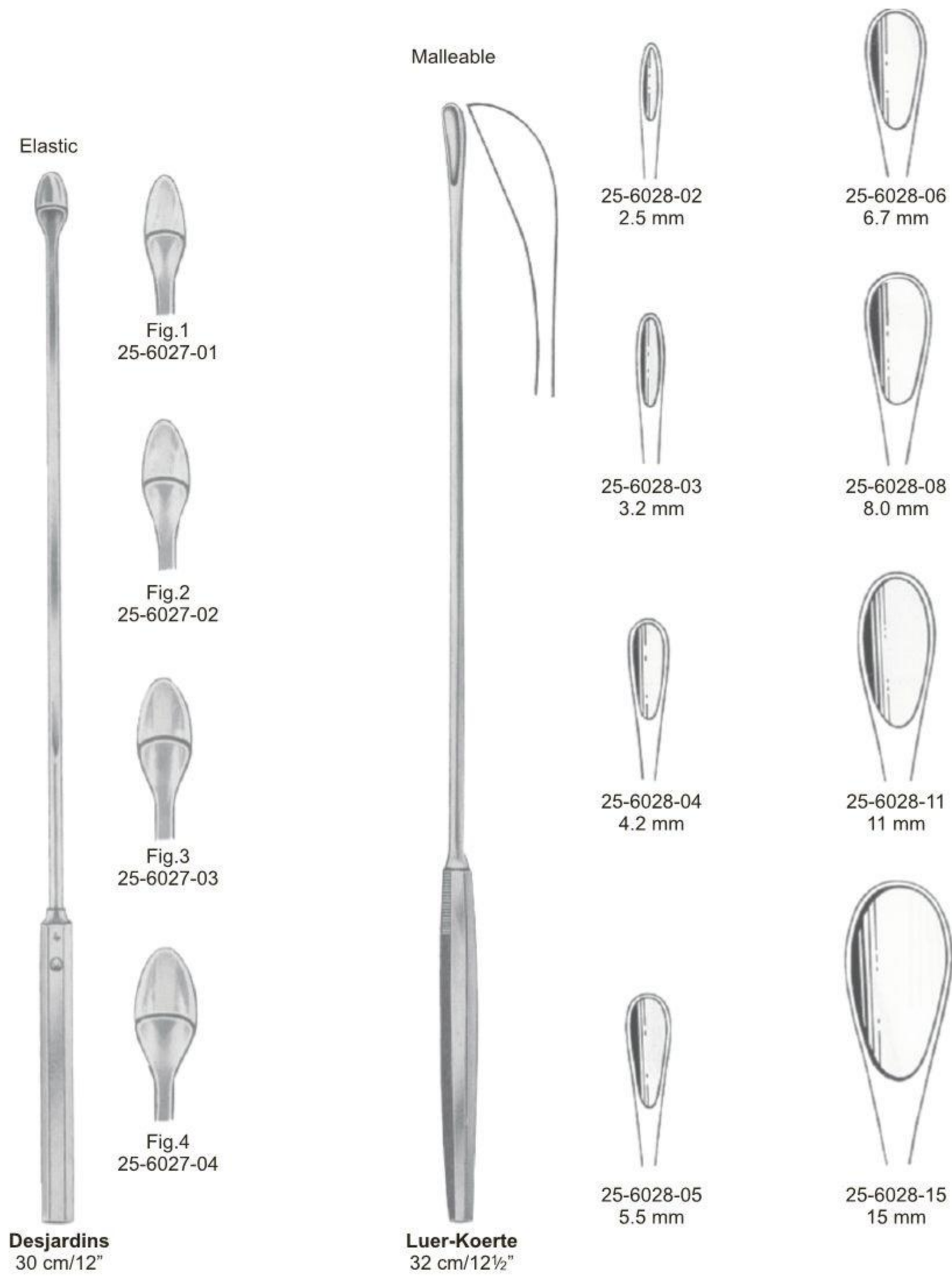



Mayo
 25-6029-28
 28 cm/11"

Malleable



Mayo
 26.5 cm/10½"



Fig. 1
 25-6030-01



Fig. 2
 25-6030-02



Fig. 3
 25-6030-03



Moore
 26-08506-28
 28 cm/11"

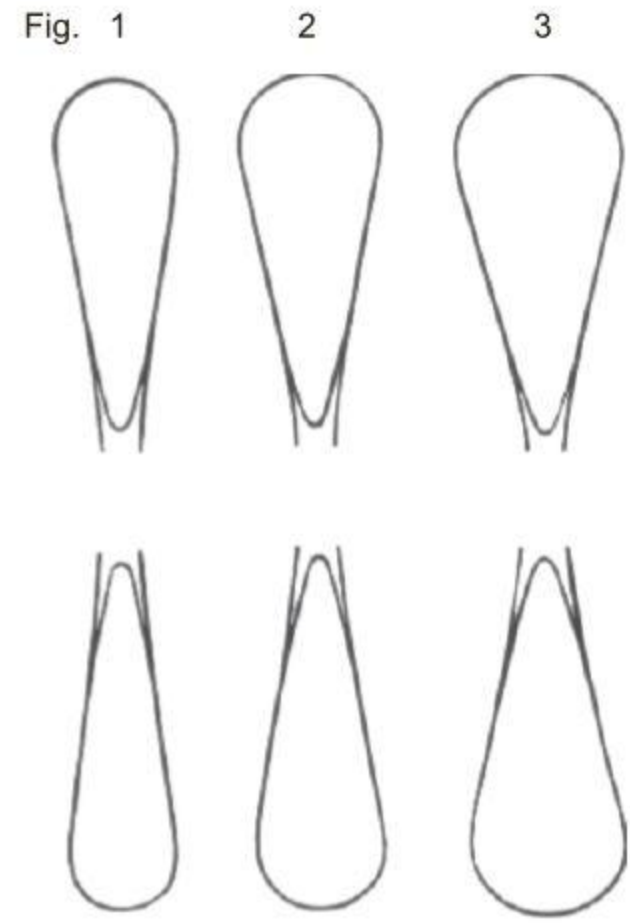
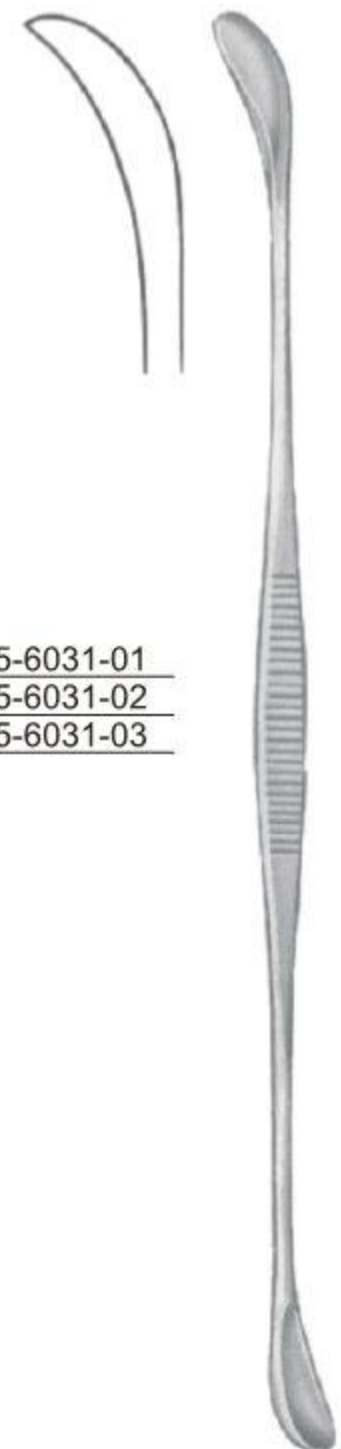

Fig.
 1 25-6031-01
 2 25-6031-02
 3 25-6031-03



Fergusson
 24 cm/9½"

- EN —● Prostatic Retractors, Prostatectomy instruments
- DE —● Postatachaken, Instrumente für prostata-operationen
- ES —● Separadores para la próstata, instrumentos para prostatectomía



Young
25-6032-21
21 cm/8 1/4"



Young
25-6033-22
22 cm/8 3/4"



Young
25-6034-21
21 cm/8 1/4"



Young
25-6035-22
22 cm/8 3/4"



Millin
25-6036-23
23 cm/9"



Millin
25-6037-23
23 cm/9"



Millin
25-6038-23
23 cm/9"



Millin
 25-6039-24
 24 cm/9½"

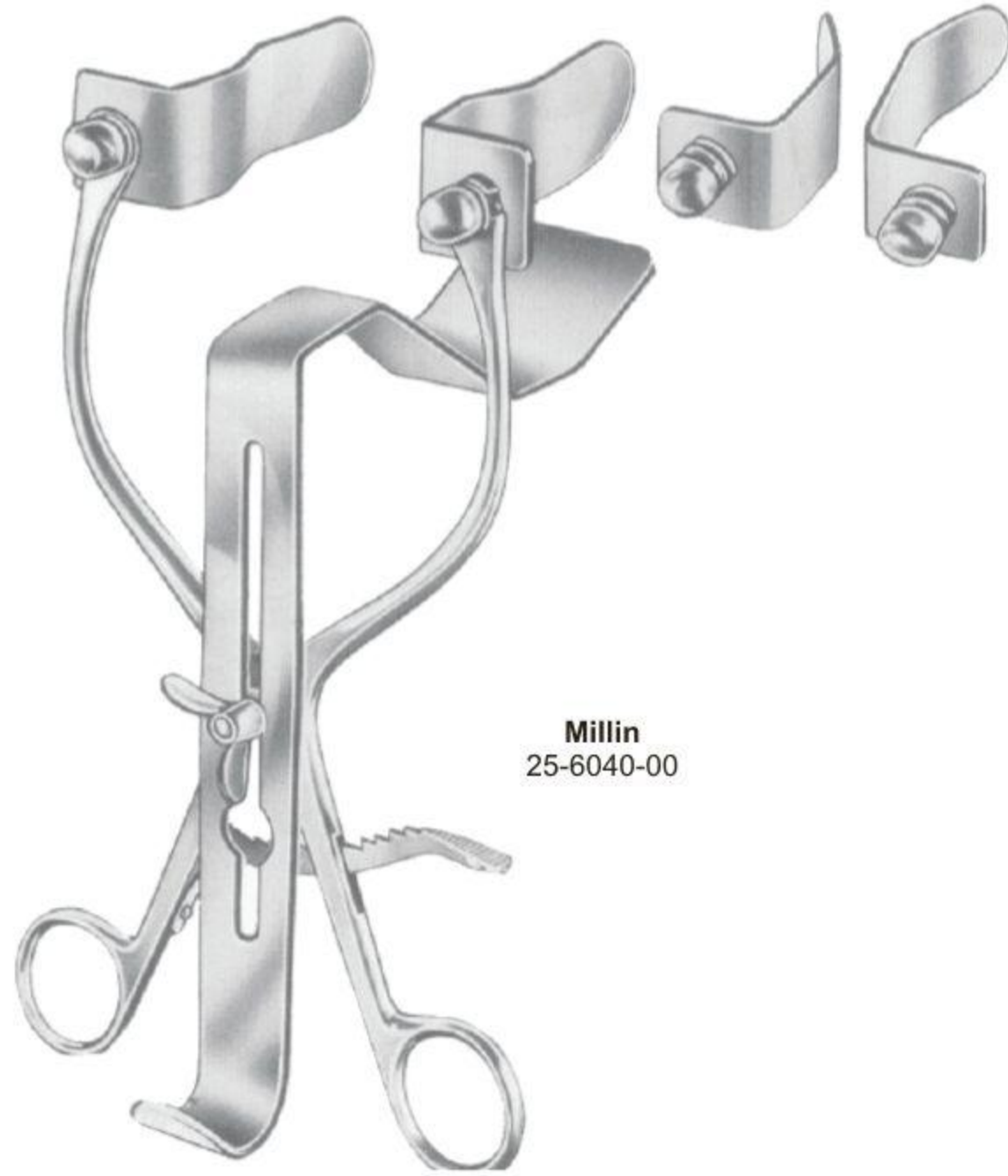

Millin
 25-6040-00



Legueu
 25-6041-00



Judd-Masson
 25-6042-00

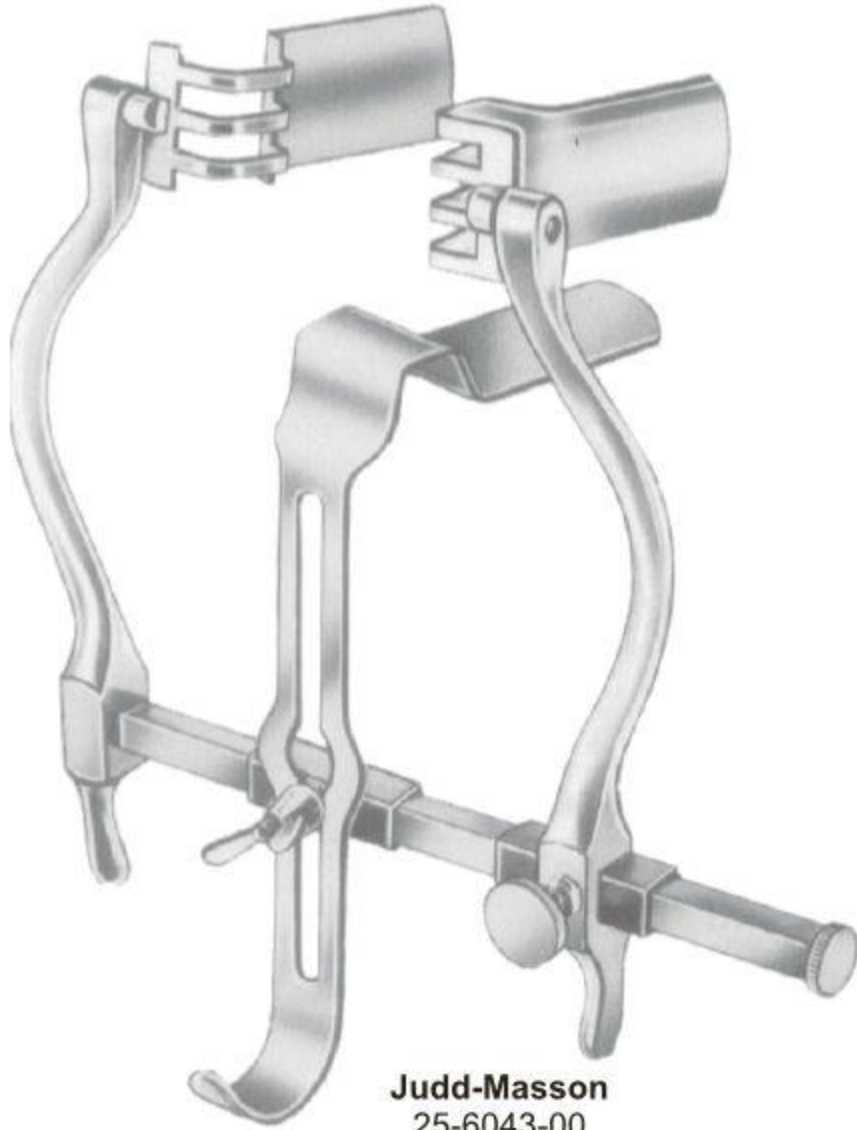

Judd-Masson
25-6043-00



Thomson-Walker
25-6044-00



Legueu
25-6045-27
27 cm/10½"
35 mm



Kocher
25-6046-26
26 cm/10¼"
67 mm

Dilating Bougies ●— EN
 Dilatationsbougies ●— DE
 Bujías dilatadoras ●— ES

mm Ø	Charriere (French)
2 2/3	8
3	9
3 1/3	10
3 2/3	11
4	12
4 1/3	13
4 2/3	14
5	15
5 1/3	16
5 2/3	17
6	18
6 1/3	19
6 2/3	20
7	21
7 1/3	22
7 2/3	23
8	24
8 1/3	25
8 2/3	26
9	27
9 1/3	28
9 2/3	29
10	30
10 1/3	32
11 2/3	34
12	36



Van Buren
 Charrier (French)
 No. 8-36
 25-6047-08
 25-6047-36
 28 cm/11"
 In Canvas Pouch
 25-6047-50
 Set of 6
 6 Pcs. 25-6047-14/24
 25-6047-24
 25-6047-60
 Set of 12
 12 Pcs 25-6047-08/36
 25-6047-36

- 25-6047-08
- 25-6047-10
- 25-6047-12
- 25-6047-14
- 25-6047-16
- 25-6047-18
- 25-6047-20
- 25-6047-22
- 25-6047-24
- 25-6047-26
- 25-6047-28
- 25-6047-30
- 25-6047-32
- 25-6047-34
- 25-6047-36



Dittel
 Charriere (French)
 No. 8-30
 25-6048-08
 25-6048-30
 19.5 cm/7 1/2"

- Straight
- 25-6048-08
 - 25-6048-09
 - 25-6048-10
 - 25-6048-11
 - 25-6048-12
 - 25-6048-13
 - 25-6048-14
 - 25-6048-15
 - 25-6048-16
 - 25-6048-17
 - 25-6048-18
 - 25-6048-19
 - 25-6048-20
 - 25-6048-21
 - 25-6048-22
 - 25-6048-23
 - 25-6048-24
 - 25-6048-25
 - 25-6048-26
 - 25-6048-27
 - 25-6048-28
 - 25-6048-26
 - 25-6048-30



Dittel
 Charriere (French)
 No. 8-30
 25-6049-08
 25-6049-30
 34.5 cm/13 1/2"

- Curved
- 25-6049-08
 - 25-6049-09
 - 25-6049-10
 - 25-6049-11
 - 25-6049-12
 - 25-6049-13
 - 25-6049-14
 - 25-6049-15
 - 25-6049-16
 - 25-6049-17
 - 25-6049-18
 - 25-6049-19
 - 25-6049-20
 - 25-6049-21
 - 25-6049-22
 - 25-6049-23
 - 25-6049-24
 - 25-6049-25
 - 25-6049-26
 - 25-6049-27
 - 25-6049-28
 - 25-6049-26
 - 25-6049-30

For men



25-6050-06
25-6050-24

For Women



	mm Ø	Charriere (French)	
25-6050-06	2	6	25-6051-06
25-6050-07	2 ¹ / ₃	7	25-6051-07
25-6050-08	2 ² / ₃	8	25-6051-08
25-6050-09	3	9	25-6051-09
25-6050-10	3 ¹ / ₃	10	25-6051-10
25-6050-11	3 ² / ₃	11	25-6051-11
25-6050-12	4	12	25-6051-12
25-6050-13	4 ¹ / ₃	13	25-6051-13
25-6050-14	4 ² / ₃	14	25-6051-14
25-6050-15	5	15	25-6051-15
25-6050-16	5 ¹ / ₃	16	25-6051-16
25-6050-17	5 ² / ₃	17	25-6051-17
25-6050-18	6	18	25-6051-18
25-6050-19	6 ¹ / ₃	19	25-6051-19
25-6050-20	6 ² / ₃	20	25-6051-20
25-6050-21	7	21	25-6051-21
25-6050-22	7 ¹ / ₃	22	25-6051-22
25-6050-23	7 ² / ₃	23	25-6051-23
25-6050-24	8	24	25-6051-24

Catheter Introducing Instruments



Guyon
25-6052-39
39 cm/15¹/₂"



Guyon
25-6053-35
35 cm/13³/₄"

Circumcision Instruments

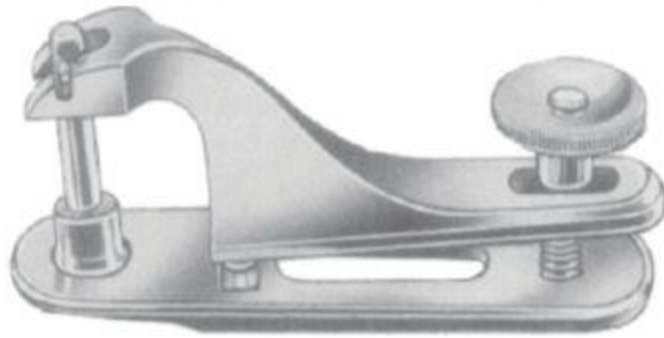

- 25-6054-08 08 mm
- 25-6054-11 11 mm
- 25-6054-13 13 mm
- 25-6054-16 16 mm
- 25-6054-21 21 mm
- 25-6054-26 26 mm
- 25-6054-32 32 mm

Foreign Body Forceps



Mathieu
 25-6055-20

Penis Clamps

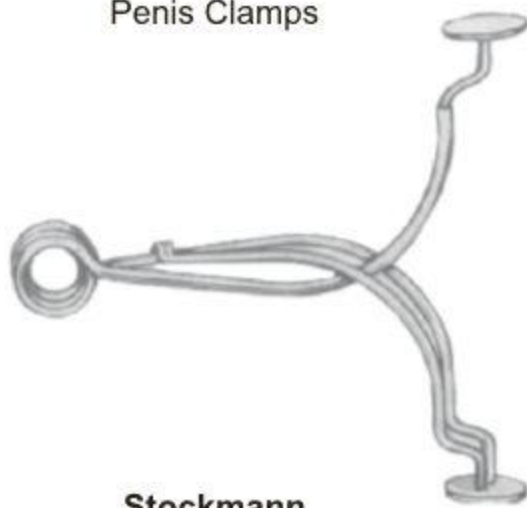

Stockmann
 25-6056-00

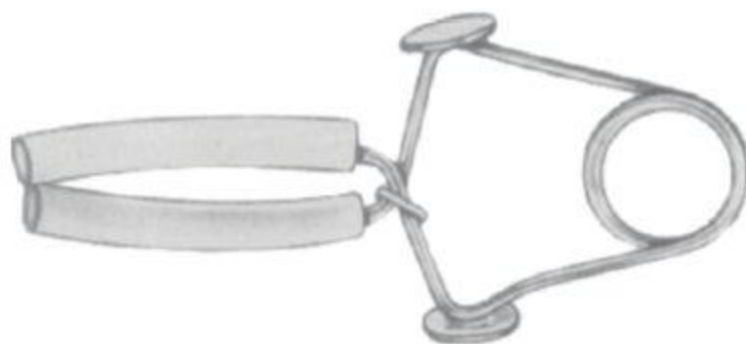

Strauss
 25-6057-00

Secretion Scoop



Guttman
 25-6058-26
 26.5 cm/10½"

- EN** Gynecology
- DE** Gynäkologie
- ES** Ginecología

Page 519 to 558



Scheme of Dimensions for Specula

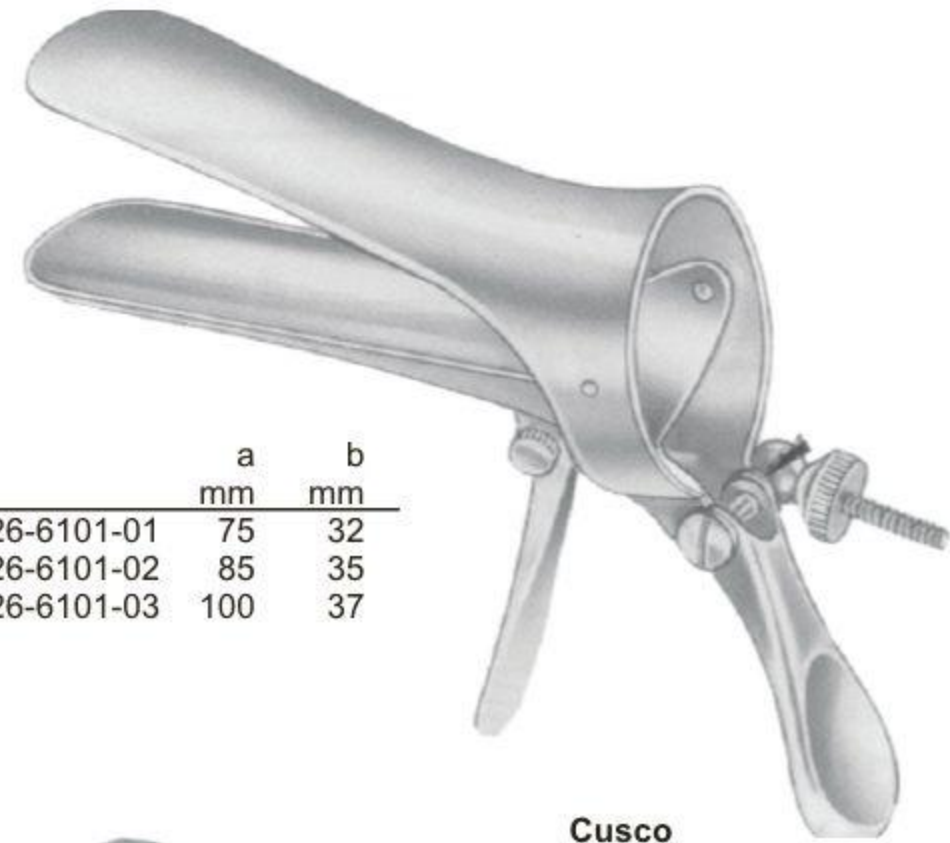
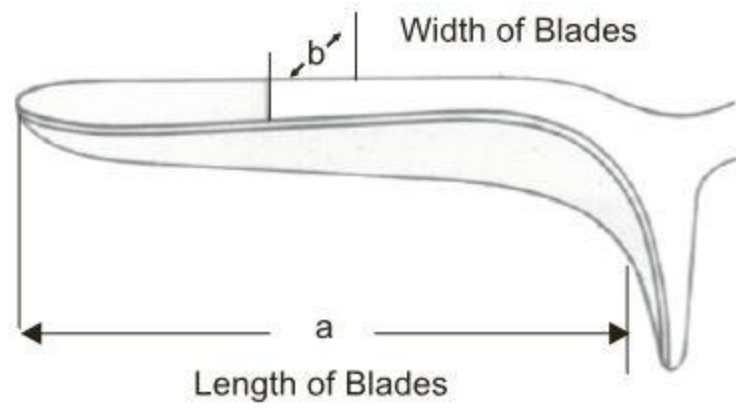

	a mm	b mm
26-6101-01	75	32
26-6101-02	85	35
26-6101-03	100	37

Cusco

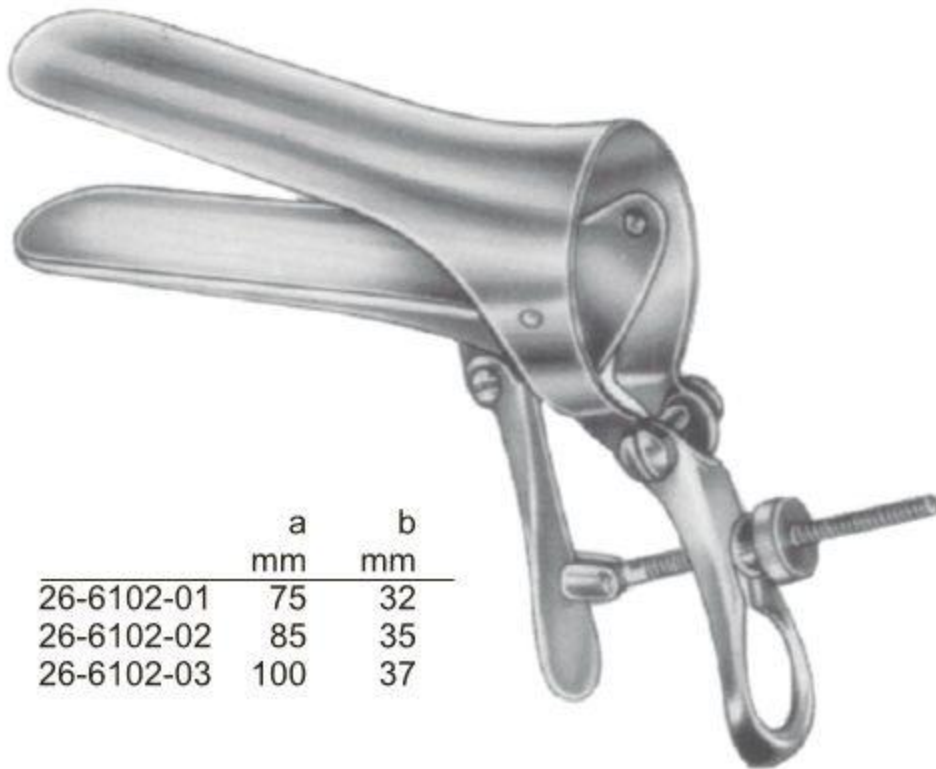

	a mm	b mm
26-6102-01	75	32
26-6102-02	85	35
26-6102-03	100	37

Cusco



For Virgins	a mm	b mm
26-6103-00	75	17

Cusco

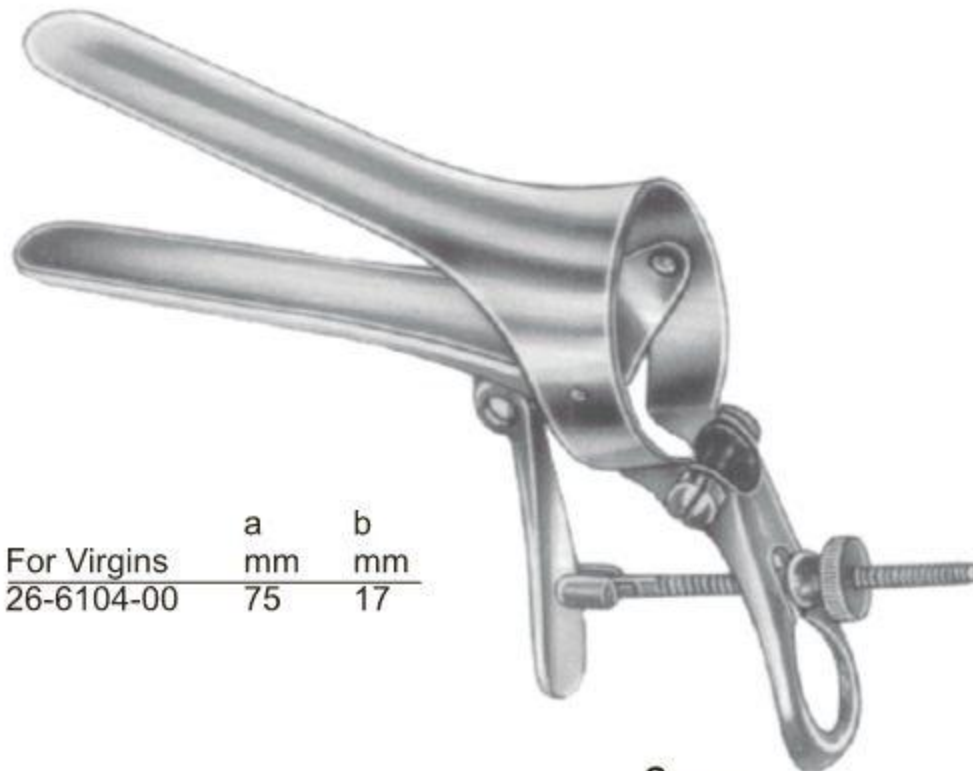

For Virgins	a mm	b mm
26-6104-00	75	17

Cusco



	a mm	b mm
26-6105-01	90	23-25
26-6105-02	100	25-27
26-6105-03	110	27-30

Cusco
Swiss Pattern

Vaginal Speculas ● EN
 Scheidenspekula ● DE
 Espéculos vaginales ● ES

**Collin-Landau**

Small	26-6106-01	30 x 85 mm
Medium	26-6106-02	35 x 100 mm
Large	26-6106-03	40 x 110 mm

**Collin**

Small	26-6107-01	30 x 85 mm
Medium	26-6107-02	35 x 100 mm
Large	26-6107-03	40 x 110 mm

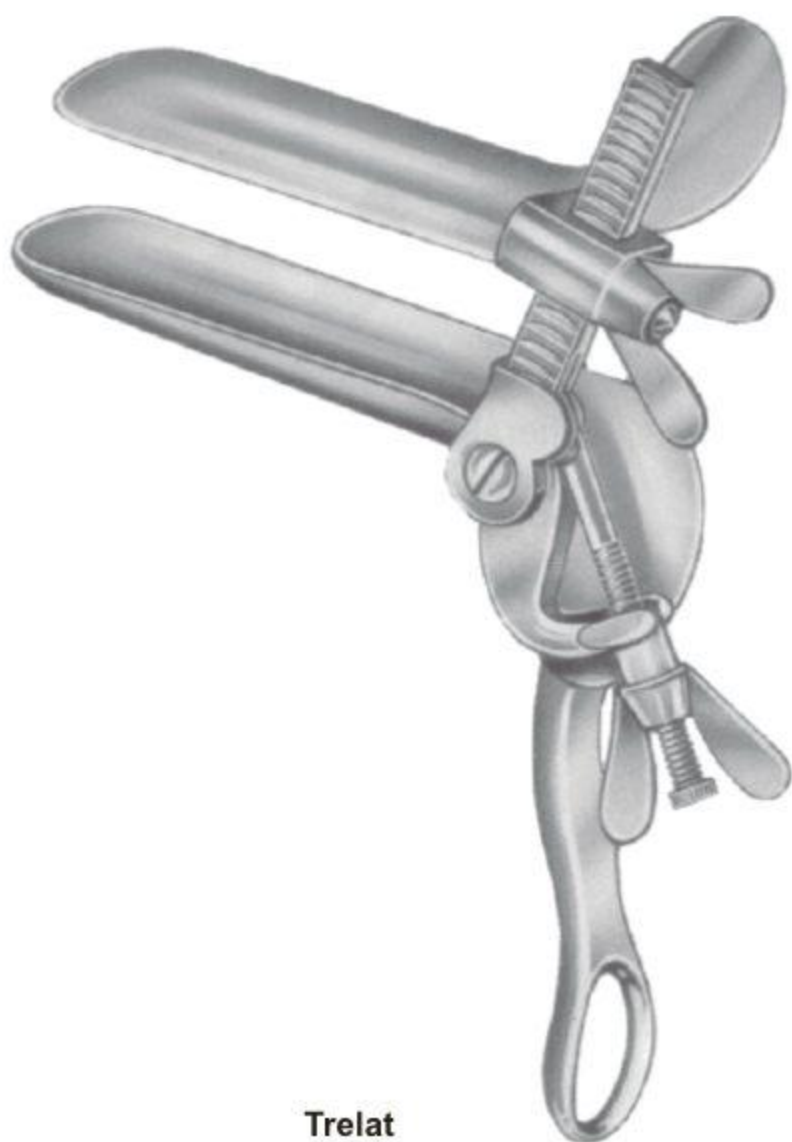
**Trelat**

	a	b
	mm	mm
26-6108-01	85	33
26-6108-02	95	35
26-6108-03	115	43

**Grave (Standard)**

	a	b
	mm	mm
26-6109-01	75	20
26-6109-02	95	30
26-6109-03	115	35
26-6109-04	125	35

Black



Grave	a mm	b mm
26-6110-01	75	20
26-6110-02	95	35
26-6110-03	115	35



Grave Angled 135°	a mm	b mm
26-6111-00	101	35

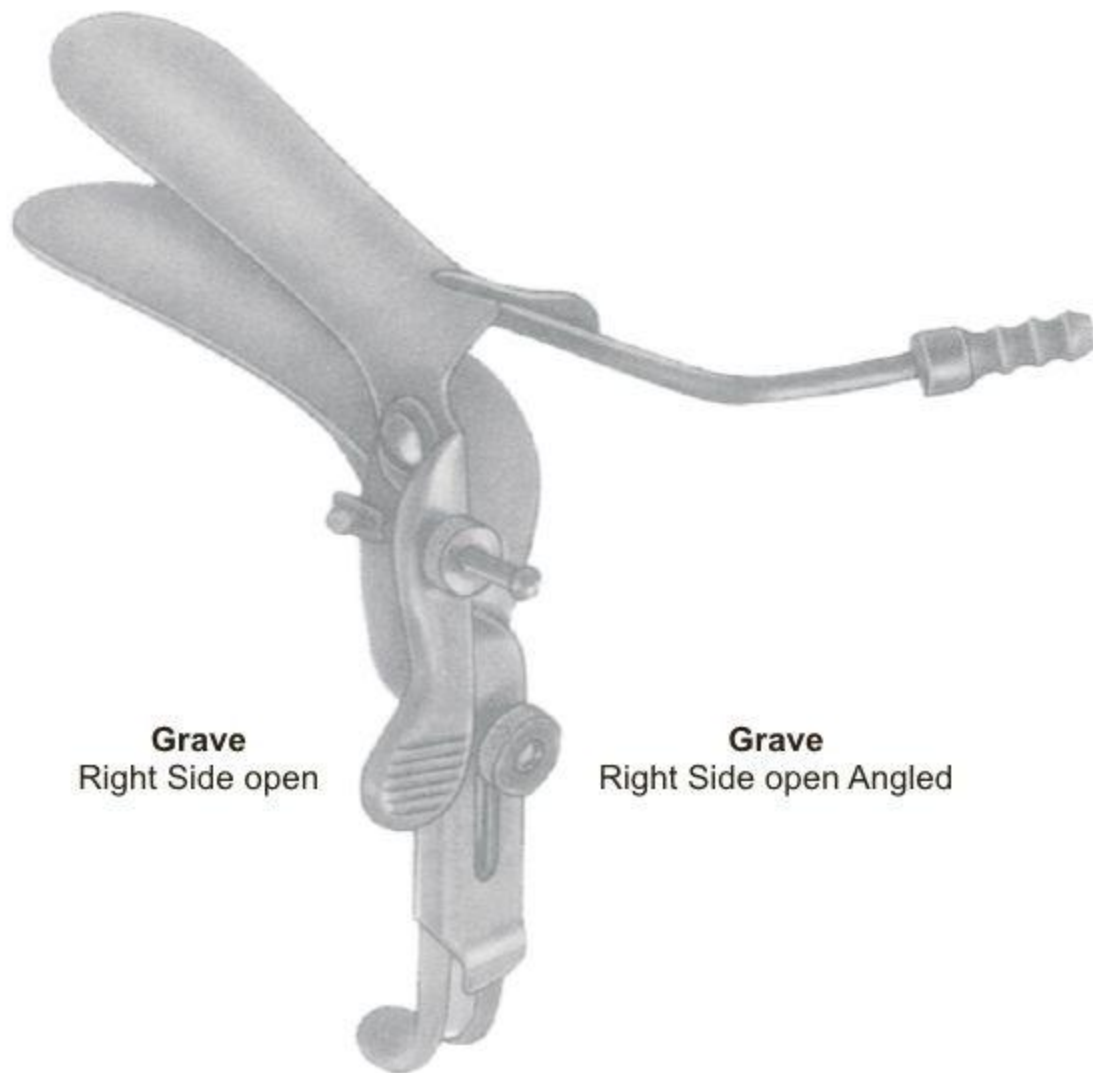

Grave
Right Side open

Grave
Right Side open Angled

	a mm	b mm
26-6112-01	101	35
26-6112-02	101	35

Lateral Specula



26-6113-00



Pederson

	a mm	b mm
26-6114-01	75	13
26-6114-02	100	22
26-6114-03	120	25

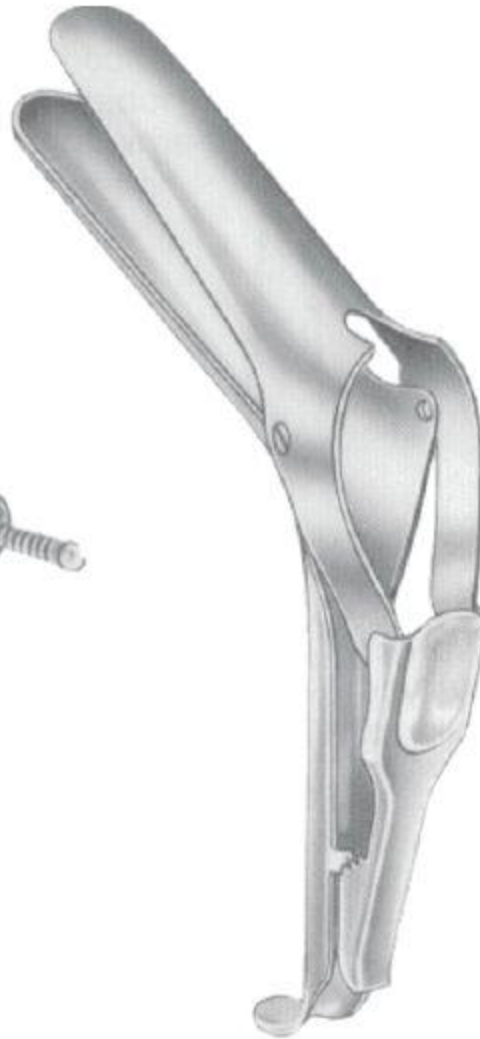

Semm

	a mm	b mm
26-6115-01	90	14/18
26-6115-02	100	17/20
26-6115-03	100	25/30

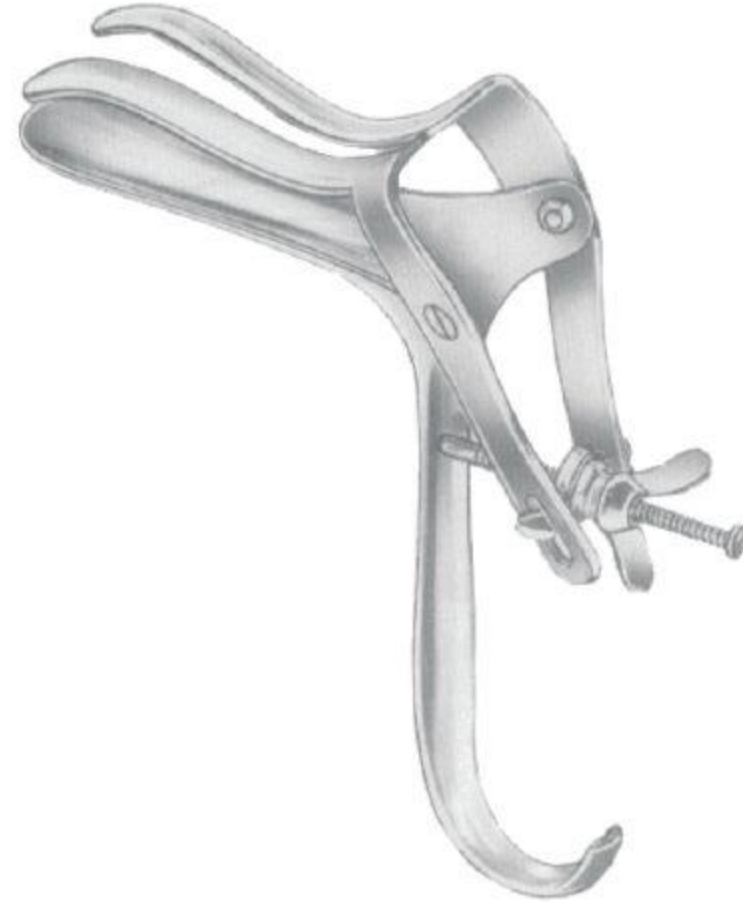

Nott

	a mm	b mm
26-6116-01	90	30
26-6116-02	110	30

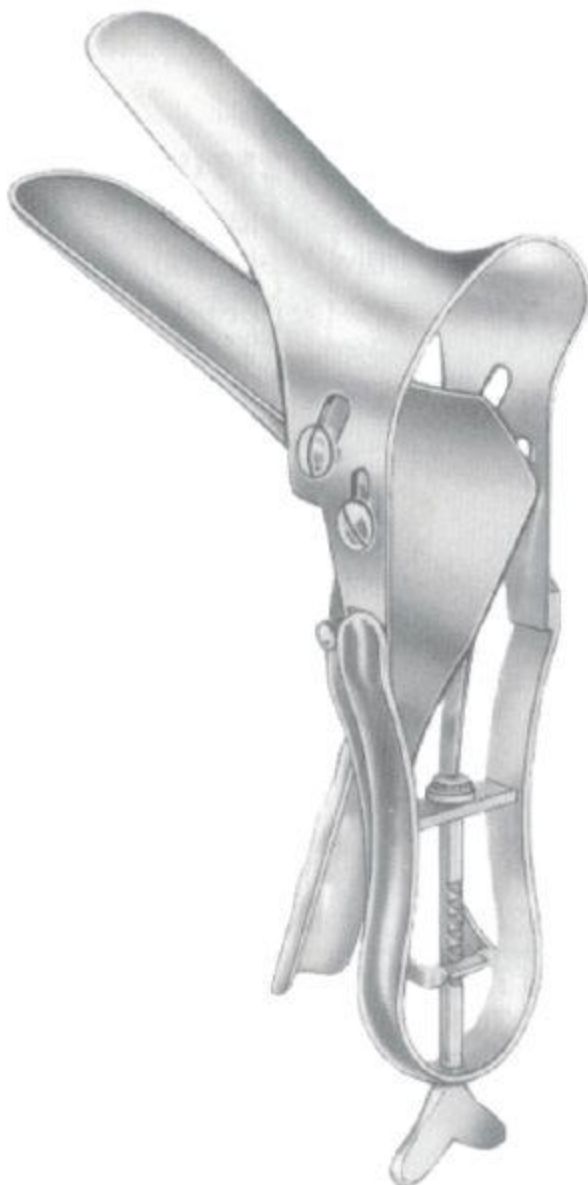

Seyffert

	a mm	b mm
26-6117-01	100	17
26-6117-02	110	33

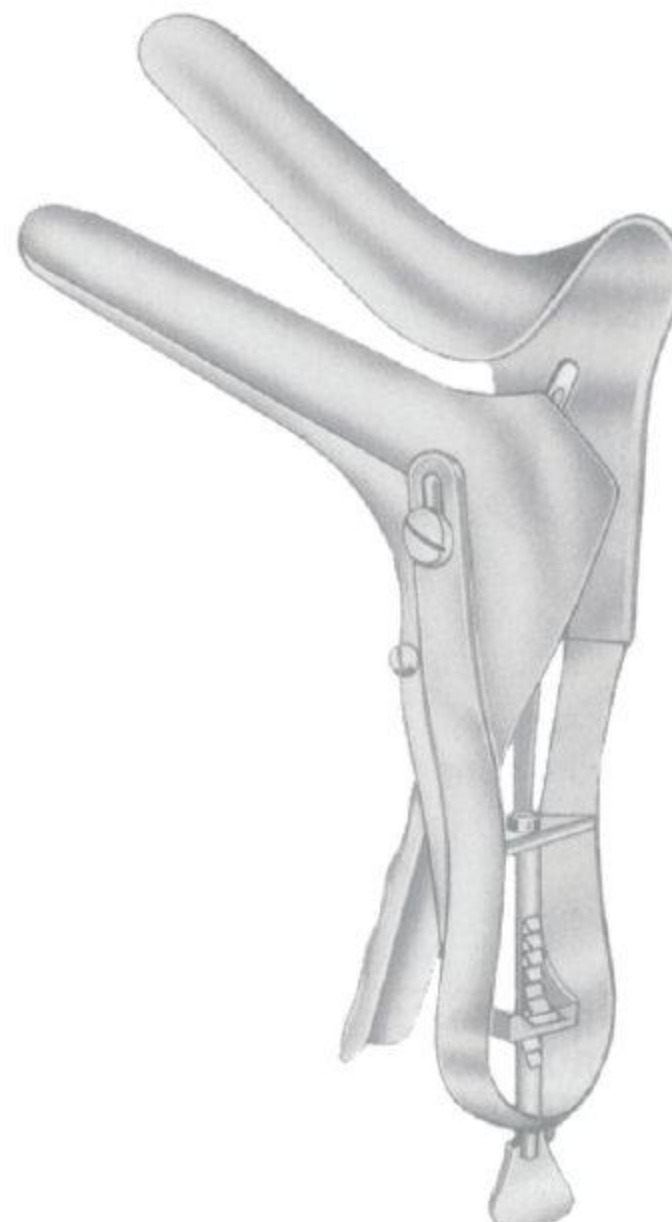

Seyffert

	a mm	b mm
26-6118-02	110	33

One Side open

Scheme of Dimensions for Specula

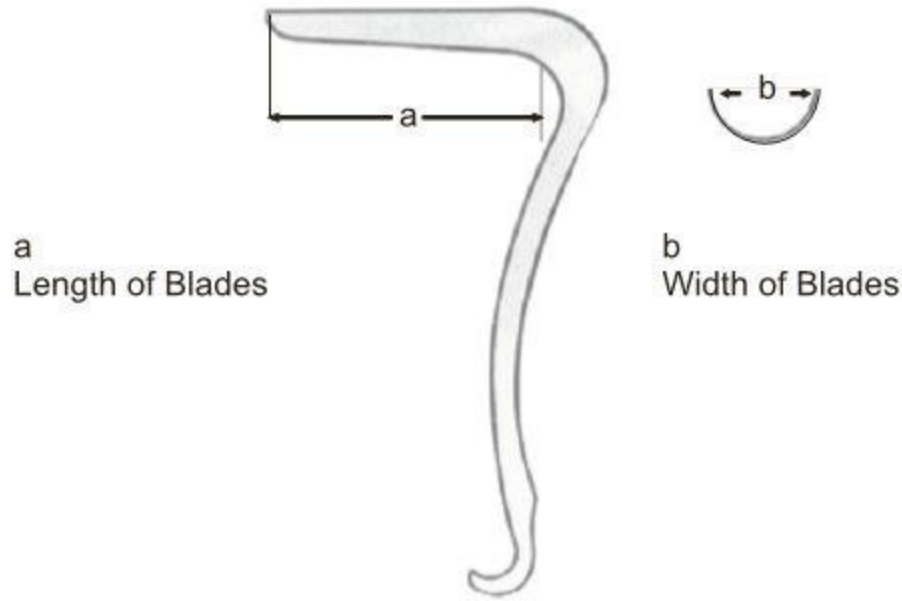

Sims (single ended)

26-6119-01	63 x 32 mm
26-6119-02	76 x 32 mm
26-6119-03	89 x 38 mm



Sims (double ended)

26-6120-01	26 x 70 mm (30 x 75 mm)
26-6120-02	30 x 75 mm (35 x 80 mm)
26-6120-03	36 x 80 mm (40 x 90 mm)



Jackson

	Fig.	a mm	b mm
26-6121-01	1	75 X 40	
26-6121-02	2	90 X 40	
26-6121-03	3	100 X 40	



Eastman

	Fig.	a mm	b mm
26-6122-01	1	76	38
26-6122-02	2	89	38
26-6122-03	3	101	38

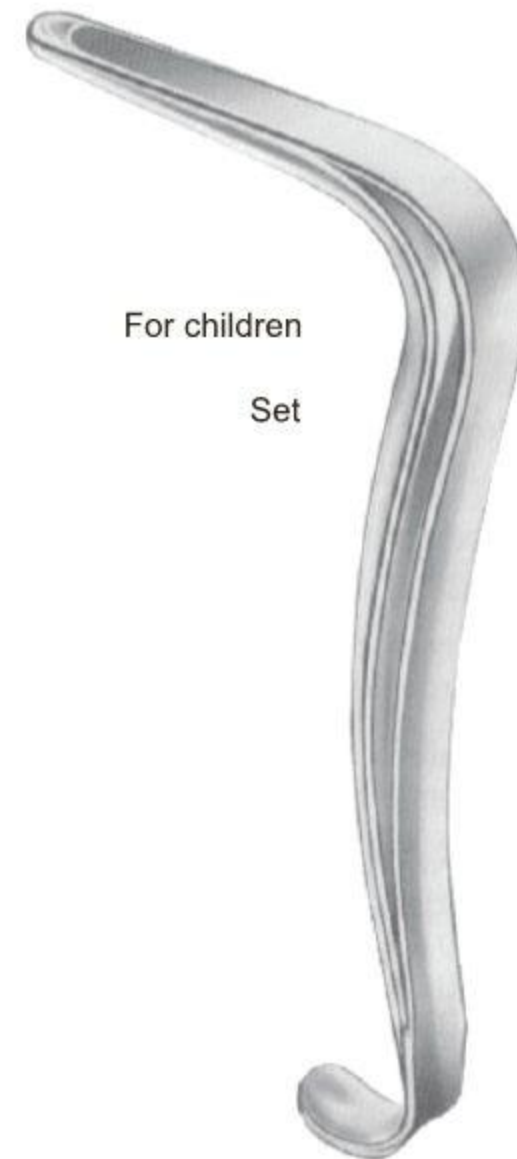

For children

Set

Kristeller

26-6123-00
70x15 mm

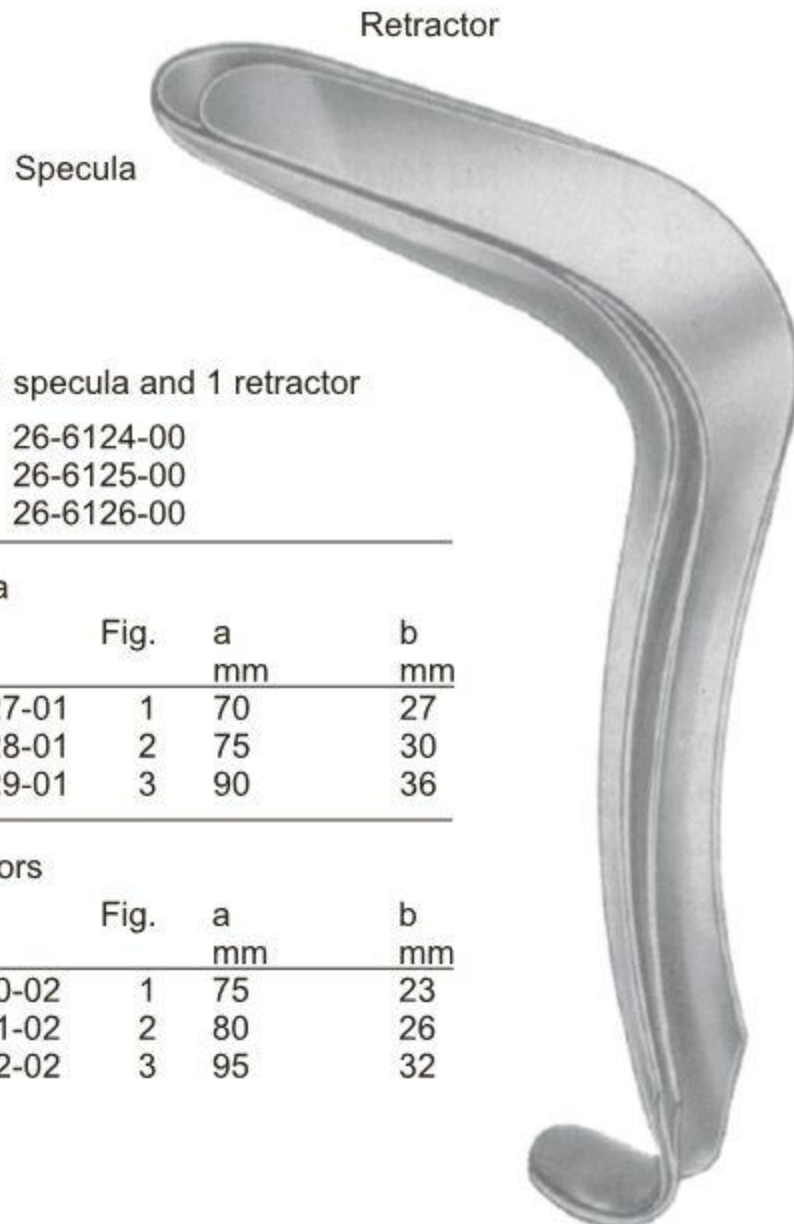

Retractor
 Specula

Set of 1 specula and 1 retractor

- Fig. 1 26-6124-00
- Fig. 2 26-6125-00
- Fig. 3 26-6126-00

Specula

	Fig.	a mm	b mm
26-6127-01	1	70	27
26-6128-01	2	75	30
26-6129-01	3	90	36

Retractors

	Fig.	a mm	b mm
26-6130-02	1	75	23
26-6131-02	2	80	26
26-6132-02	3	95	32

Kristeller
 (Standard)

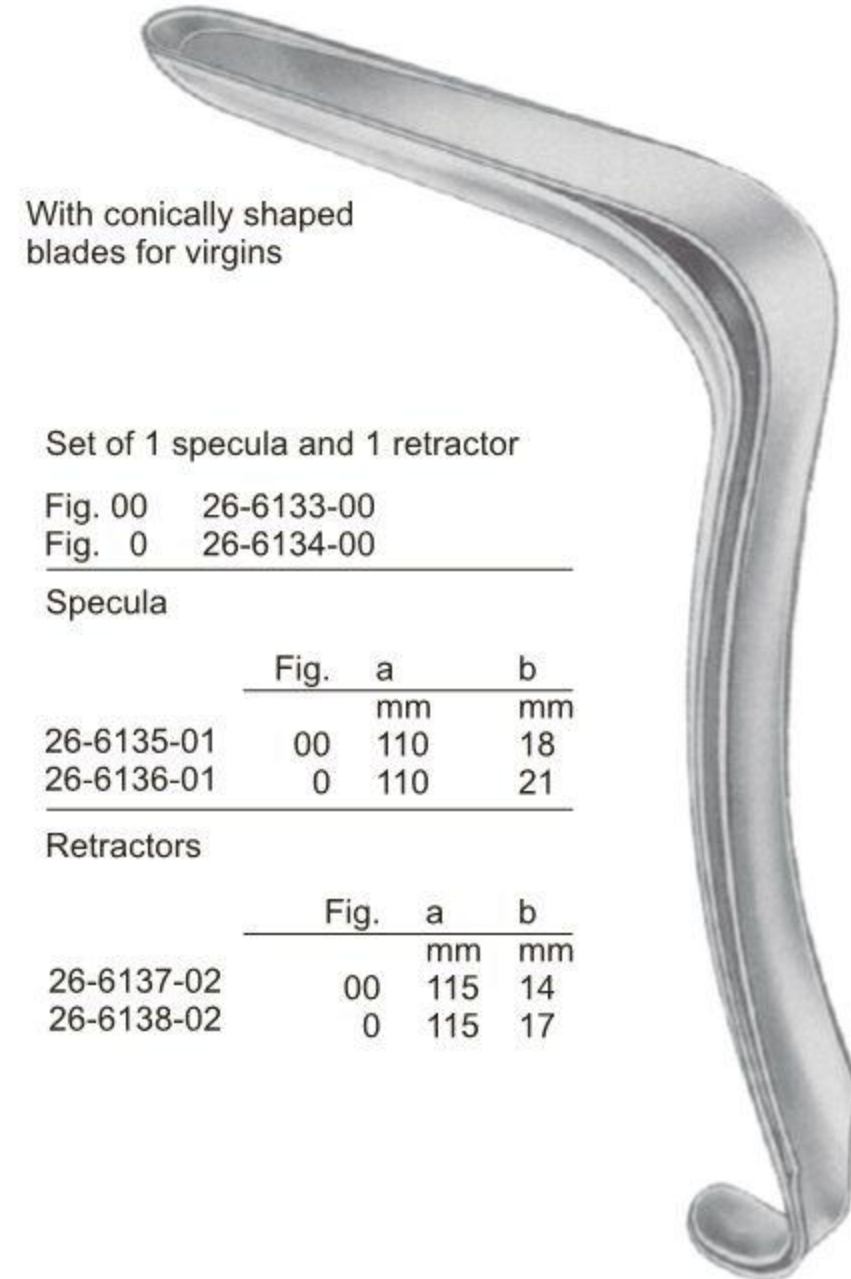

With conically shaped blades for virgins

Set of 1 specula and 1 retractor

- Fig. 00 26-6133-00
- Fig. 0 26-6134-00

Specula

	Fig.	a mm	b mm
26-6135-01	00	110	18
26-6136-01	0	110	21

Retractors

	Fig.	a mm	b mm
26-6137-02	00	115	14
26-6138-02	0	115	17

Kristeller

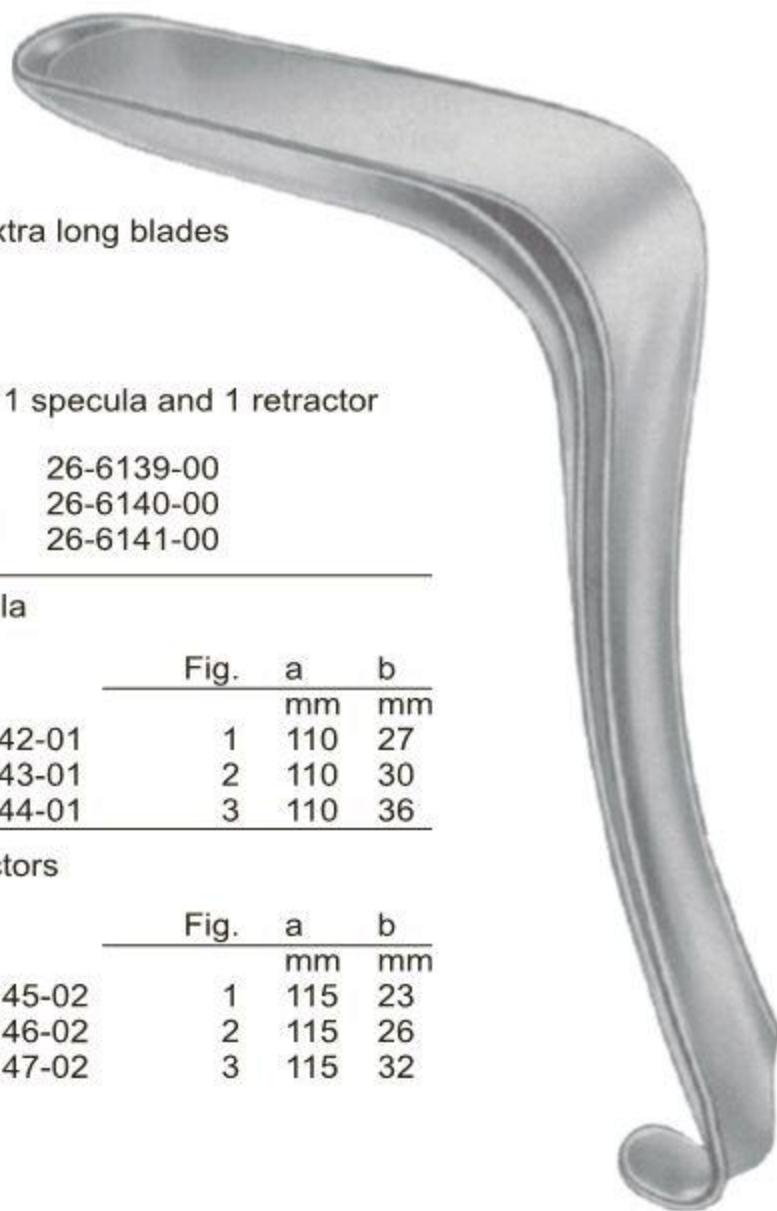

With extra long blades

Set of 1 specula and 1 retractor

- Fig. 1 26-6139-00
- Fig. 2 26-6140-00
- Fig. 3 26-6141-00

Specula

	Fig.	a mm	b mm
26-6142-01	1	110	27
26-6143-01	2	110	30
26-6144-01	3	110	36

Retractors

	Fig.	a mm	b mm
26-6145-02	1	115	23
26-6146-02	2	115	26
26-6147-02	3	115	32

Kristeller
 (Standard)

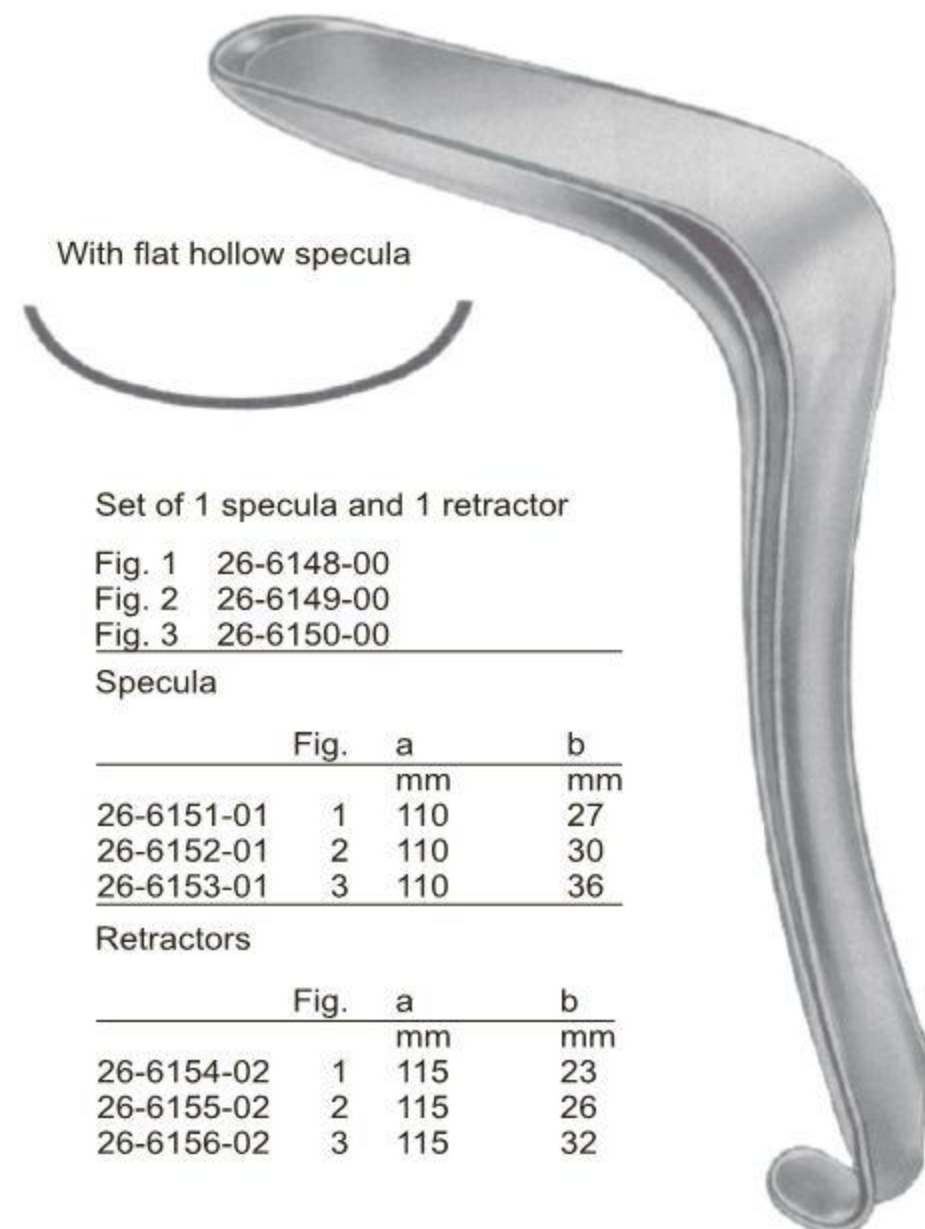

With flat hollow specula

Set of 1 specula and 1 retractor

- Fig. 1 26-6148-00
- Fig. 2 26-6149-00
- Fig. 3 26-6150-00

Specula

	Fig.	a mm	b mm
26-6151-01	1	110	27
26-6152-01	2	110	30
26-6153-01	3	110	36

Retractors

	Fig.	a mm	b mm
26-6154-02	1	115	23
26-6155-02	2	115	26
26-6156-02	3	115	32

Kristeller

	a mm	b mm
26-6157-20	100	20
26-6157-25	100	25
26-6157-30	100	30
26-6157-35	100	35
26-6157-40	100	40
26-6158-20	130	20
26-6158-25	130	25
26-6158-30	130	30
26-6158-35	130	35
26-6158-40	130	40

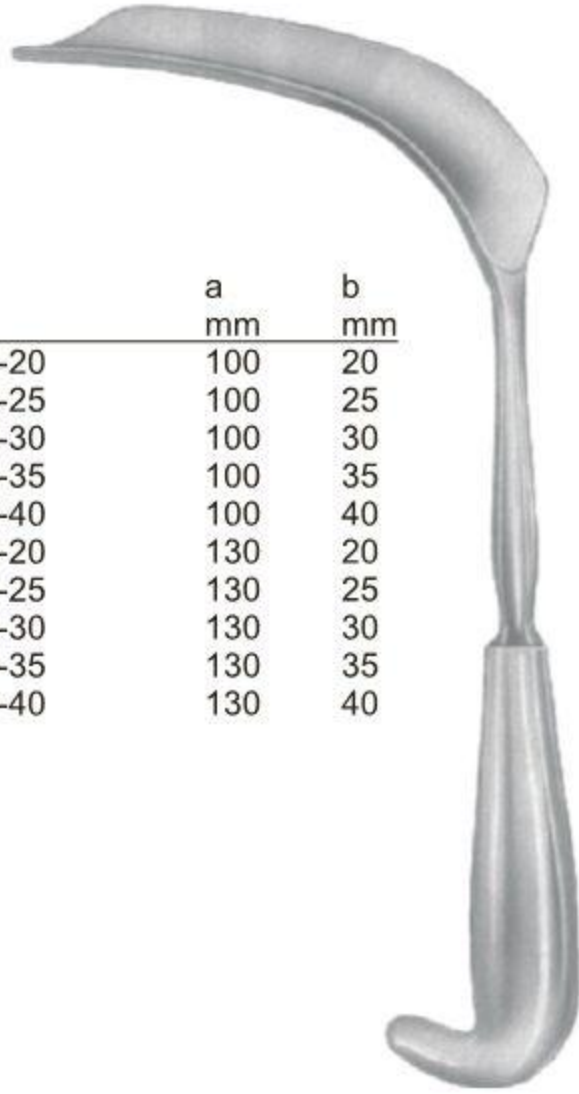

Matzenauer



Braun
26-6159-18
18 cm/7"
56x13 mm



Braun
26-6160-18
18 cm/7"
60x10 mm



Ulrich
26-6161-19
19.5 cm/7½"
80x20 mm



26-6162-19
19 cm/7½"
85x17 mm

Set

26-6163-00	Fig. 1
26-6164-00	Fig. 2

Specula

	Fig.	a mm	b mm
26-6165-01	1	70	40
26-6166-01	2	90	40

Retractors

	Fig.	a mm	b mm
26-6167-02	1	70	33
26-6168-02	2	90	33

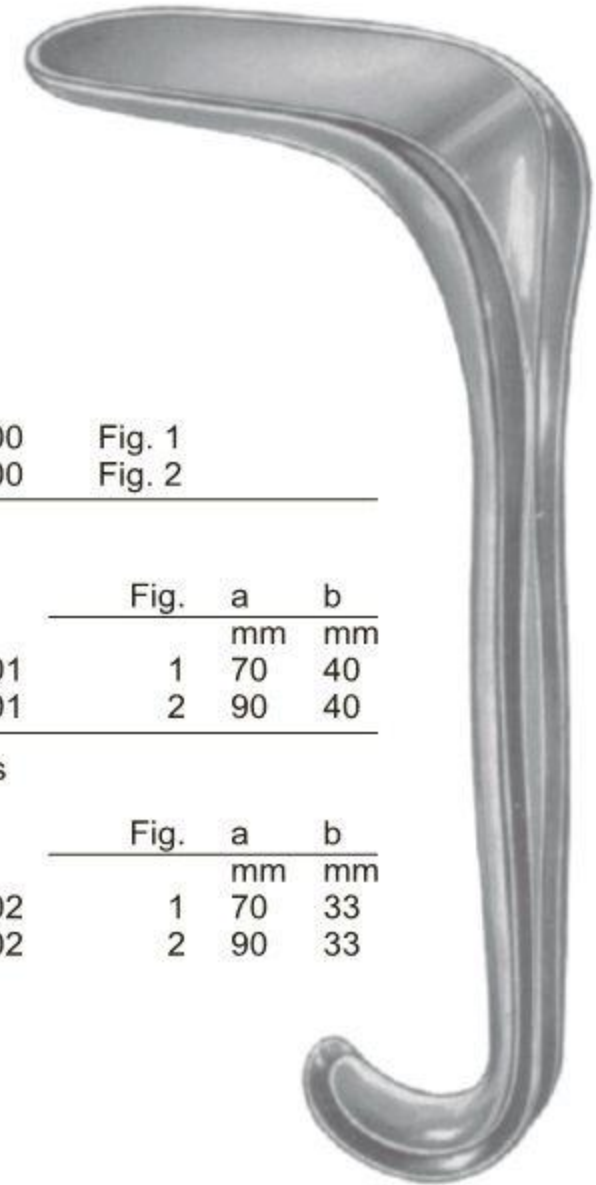

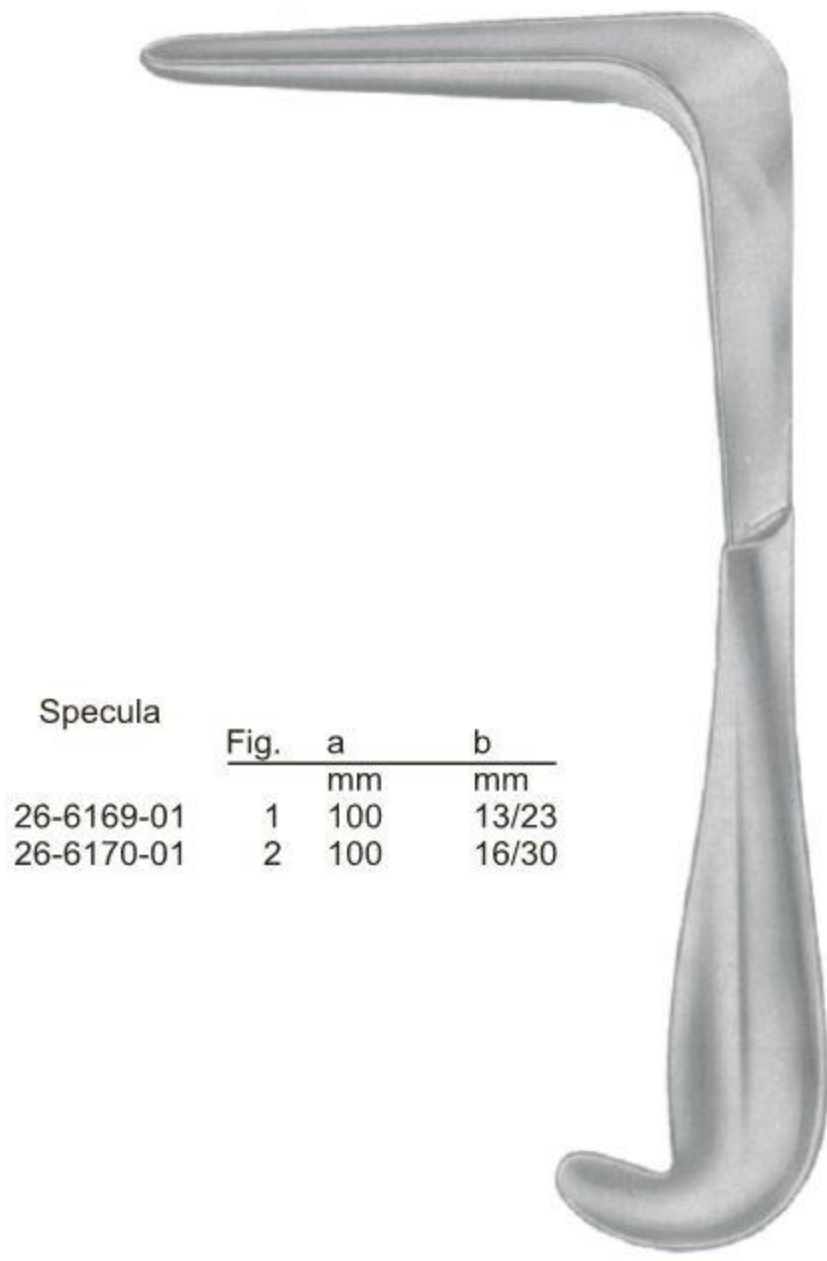

Mathieu

Specula			
	Fig.	a	b
		mm	mm
26-6169-01	1	100	13/23
26-6170-01	2	100	16/30

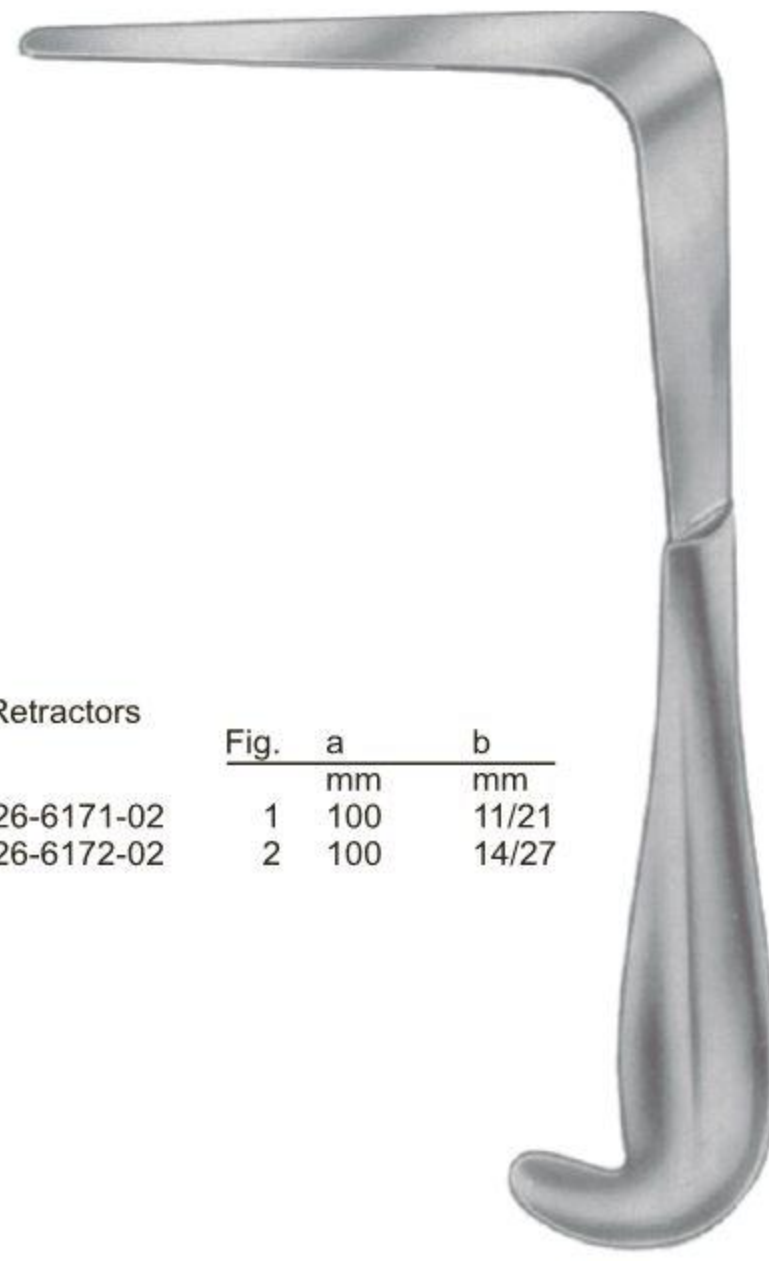

Mathieu

Retractors			
	Fig.	a	b
		mm	mm
26-6171-02	1	100	11/21
26-6172-02	2	100	14/27



Doyen

	Fig.	a	b
		mm	mm
26-6173-01	1	75	45
26-6173-02	2	90	45
26-6173-03	3	110	45



Doyen
 Hollow handle 28cm/11"

26-6174-01	75 x 280mm
26-6174-02	90 x 280mm
26-6174-03	100 x 280mm
26-6174-03	115 x 280mm

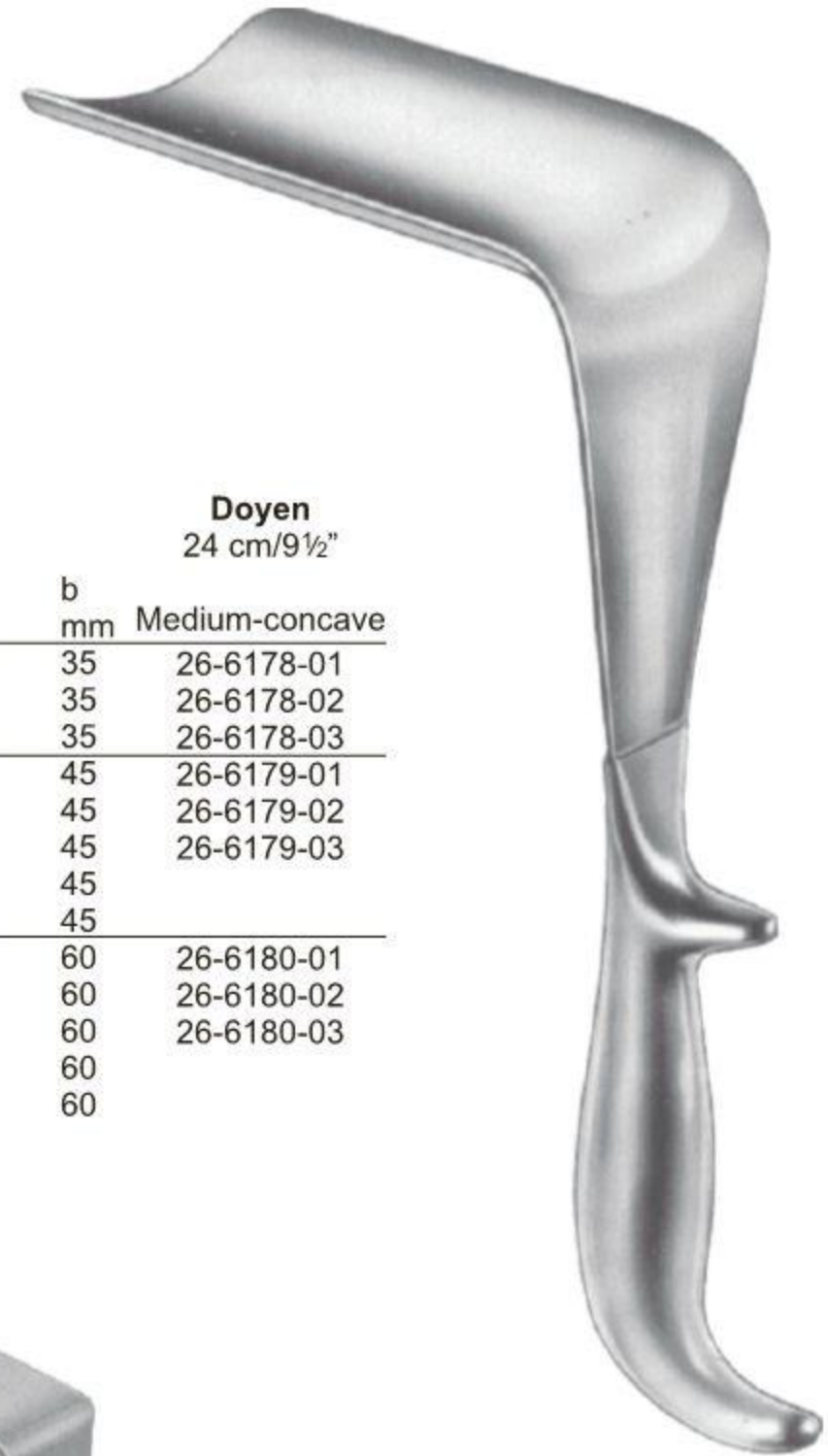

Doyen 24 cm/9½"		Fig.	a mm	b mm	Doyen 24 cm/9½"
slightly-concave					Medium-concave
26-6175-01	1	55	35	26-6178-01	
26-6175-02	2	85	35	26-6178-02	
26-6175-03	3	115	35	26-6178-03	
26-6176-01	1	55	45	26-6179-01	
26-6176-02	2	85	45	26-6179-02	
26-6176-03	3	115	45	26-6179-03	
26-6176-04	4	160	45		
26-6176-05	5	180	45		
26-6177-01	1	55	60	26-6180-01	
26-6177-02	2	85	60	26-6180-02	
26-6177-03	3	115	60	26-6180-03	
26-6177-04	4	160	60		
26-6177-05	5	180	60		



Doyen
25 cm/10"

	a mm	b mm
26-6181-01	60	30
26-6181-02	70	30
26-6181-03	80	30



Auvard
 with removable weight
 26-6182-01
 80x38 mm
 26-6182-02
 105x42 mm



Auvard
 with fixed weight
 26-6183-01
 70x38 mm
 26-6183-02
 102x45 mm



Landau

	a	b
	mm	mm
26-6184-01	100	28
26-6184-02	100	38



Breisky

	a	b
	mm	mm
26-6185-20	100	20
26-6185-25	100	25
26-6185-30	100	30
26-6185-35	100	35
26-6185-40	100	40
26-6186-20	130	20
26-6186-25	130	25
26-6186-30	130	30
26-6186-35	130	35
26-6186-40	130	40
26-6187-20	160	20
26-6187-25	160	25
26-6187-30	160	30
26-6187-35	160	35
26-6187-40	160	40
26-6188-20	180	20
26-6188-25	180	25
26-6188-30	180	30
26-6188-35	180	35
26-6188-40	180	40



Gelpi
Vulva self retaining
26-6189-20 20cm/8"



Comyn Berkeley
Vulva self retaining
26-6190-15 15.5cm/6"

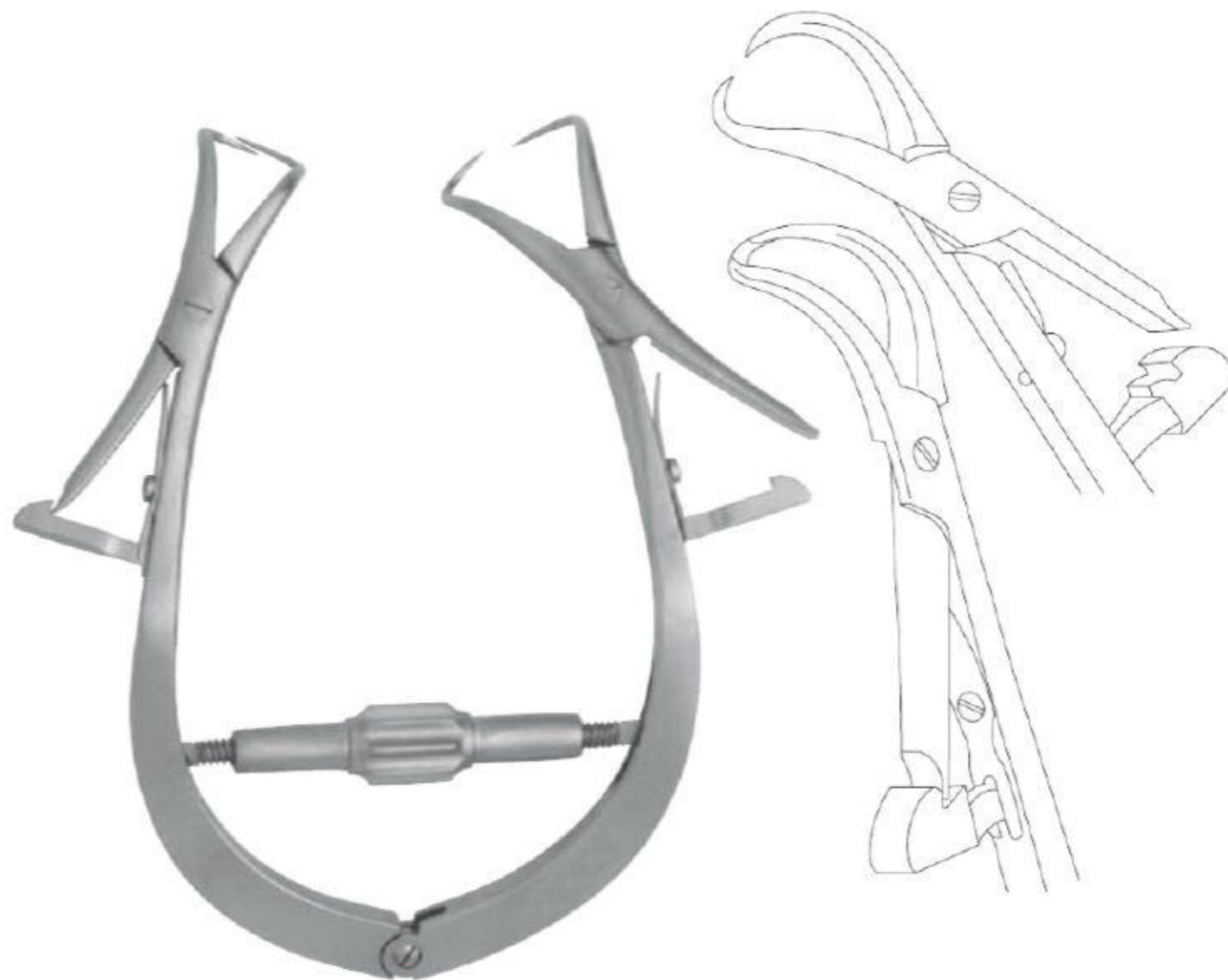

Joll
Thyroid self retaining
26-6191-15 15.5cm/6"

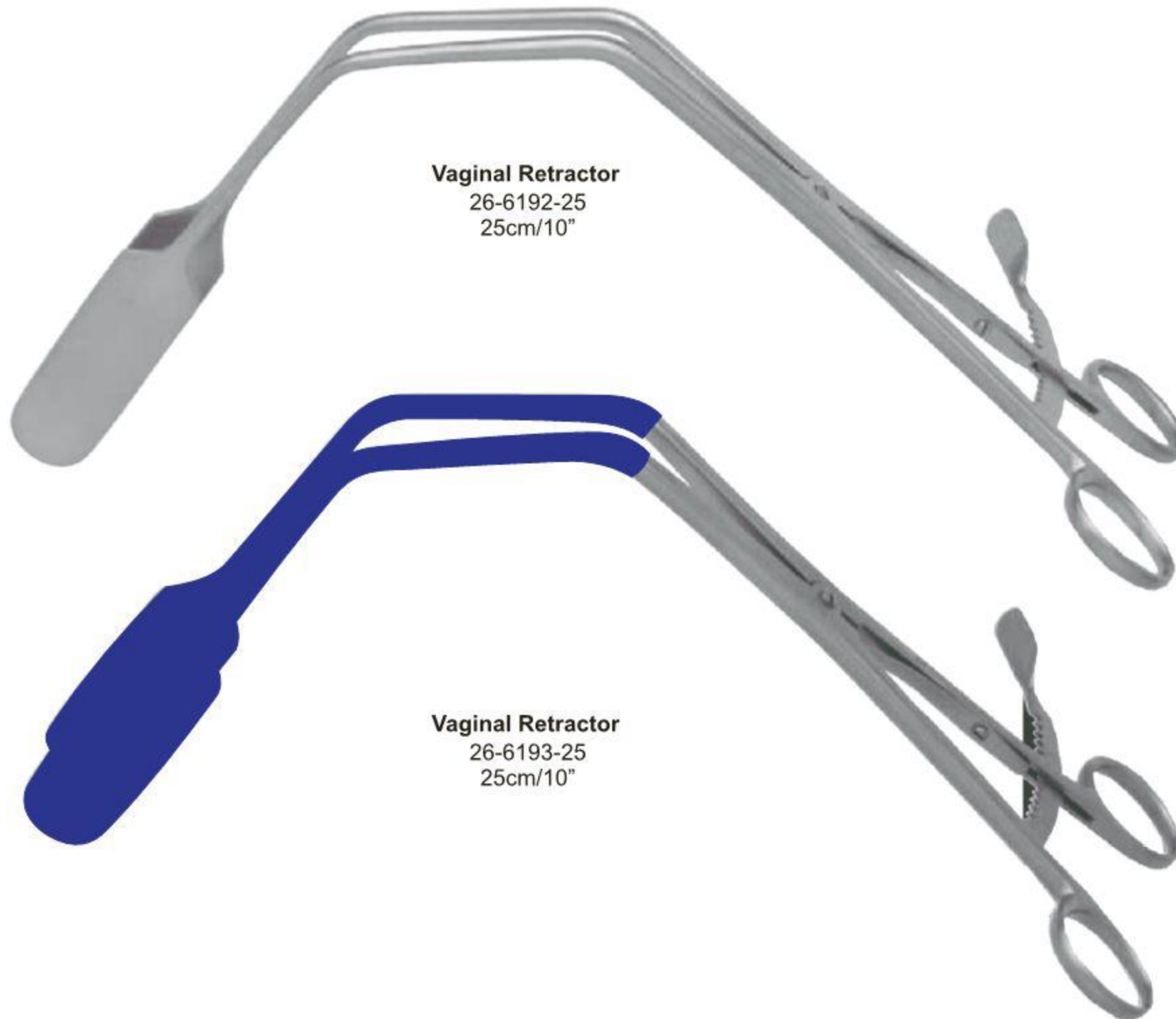
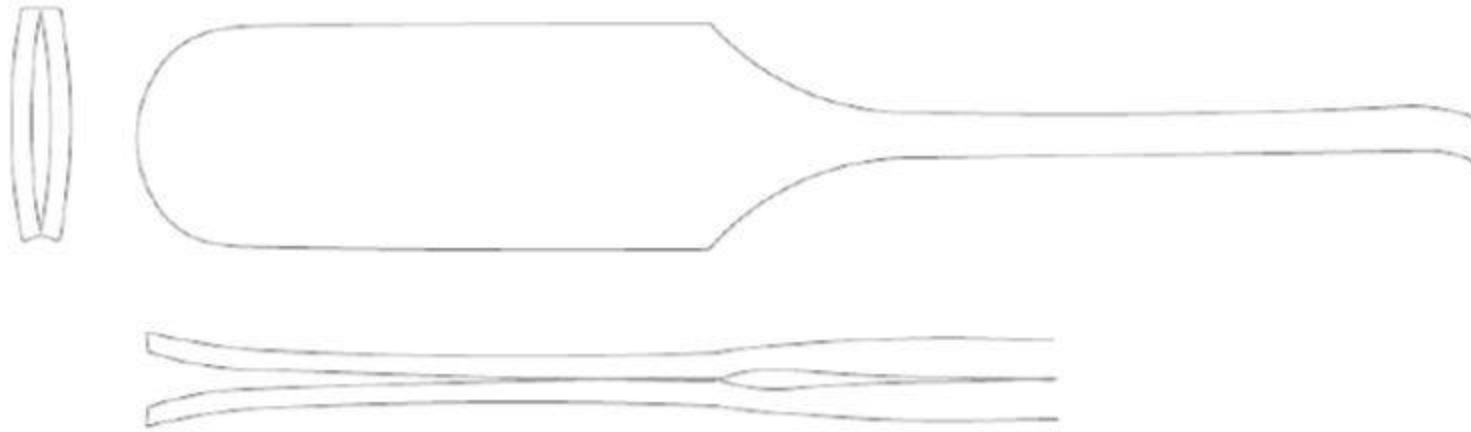

Vaginal Retractor
26-6192-25
25cm/10"

Vaginal Retractor
26-6193-25
25cm/10"



Scherbak
26-6194-00

Complete



26-6194-01
80x30 mm



26-6194-02
85x35 mm



26-6194-03
90x40 mm



26-6194-04
55x40/60 mm



26-6194-05
70x45/70 mm



	Fig.	a mm	b mm
26-6195-01	1	45	17
26-6195-02	2	90	37
26-6195-03	3	90	45



O'Sullivan-O'Connor
26-6195-00
Complete

Uterine Dilators ●— EN
 Uterus-Dilatatoren ●— DE
 Dilatadores uterinos ●— ES



Hegar
single ended
18.5 cm long

mmØ	
2.0	26-6196-02
3.0	26-6196-03
4.0	26-6196-04
5.0	26-6196-05
6.0	26-6196-06
7.0	26-6196-07
8.0	26-6196-08
9.0	26-6196-09
10.0	26-6196-10
11.0	26-6196-11
12.0	26-6196-12
13.0	26-6196-13
14.0	26-6196-14
15.0	26-6196-15
16.0	26-6196-16
17.0	26-6196-17
18.0	26-6196-18
19.0	26-6196-19
20.0	26-6196-20
21.0	26-6196-21
22.0	26-6196-22
23.0	26-6196-23
24.0	26-6196-24
25.0	26-6196-25
26.0	26-6196-26

Pieces per set

26-6197-50	12	3 -14 mm
26-6198-60	25	2 - 26 mm



Hegar
double ended
20 cm long

Ø mm	
1/2	26-6199-02
3/4	26-6199-04
5/6	26-6199-06
7/8	26-6199-08
9/10	26-6199-10
11/12	26-6199-12
13/14	26-6199-14
15/16	26-6199-16
17/18	26-6199-18
19/20	26-6199-20
21/22	26-6199-22
23/24	26-6199-24
25/26	26-6199-26

Pieces per set		set
26-6200-00	08	3/4 - 17/18 mm
26-6200-00	12	1/2 - 23/24 mm



mm	
3/6	26-6202-03
4/7	26-6202-04
5/8	26-6202-05
6/9	26-6202-06
7/10	26-6202-07
8/11	26-6202-08
9/12	26-6202-09
10/13	26-6202-10
11/14	26-6202-11
12/15	26-6202-12
13/16	26-6202-13
14/17	26-6202-14
15/18	26-6202-15
16/19	26-6202-16
17/20	26-6202-17
18/21	26-6202-18

Hawkin Ambler
26-6201-16
17 cm long
set of 16 3/6 - 18/21



Hank
26-6203-30

mm	
9/10	26-6204-10
11/12	26-6204-12
13/14	26-6204-14
15/16	26-6204-16
17/18	26-6204-18
19/20	26-6204-20

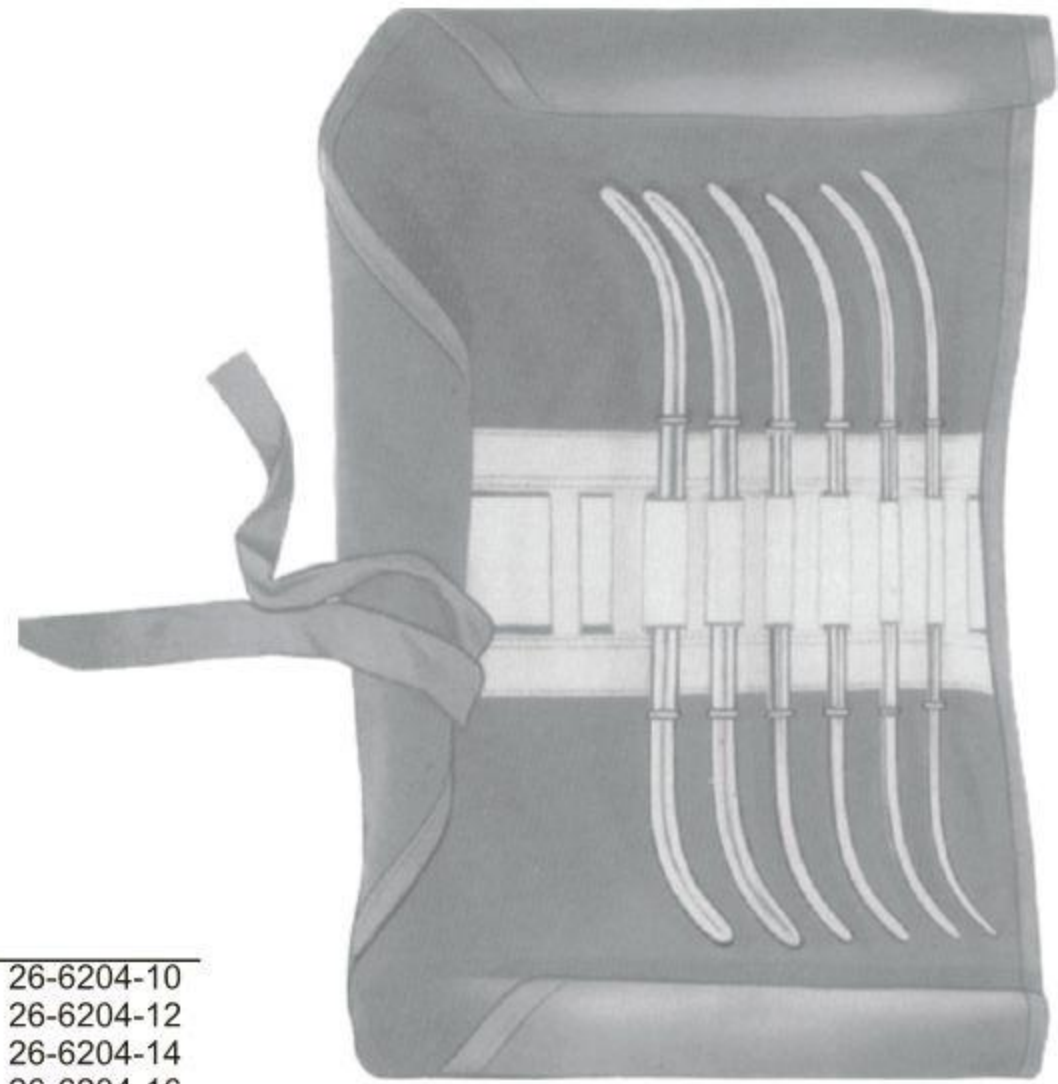

Set
26-6205-00
double ended
27 cm



Pratt

mm	
13/15	26-6206-15
17/19	26-6206-19
21/23	26-6206-23
25/27	26-6206-27
29/31	26-6206-31
33/35	26-6206-35
37/39	26-6206-39
41/43	26-6206-43

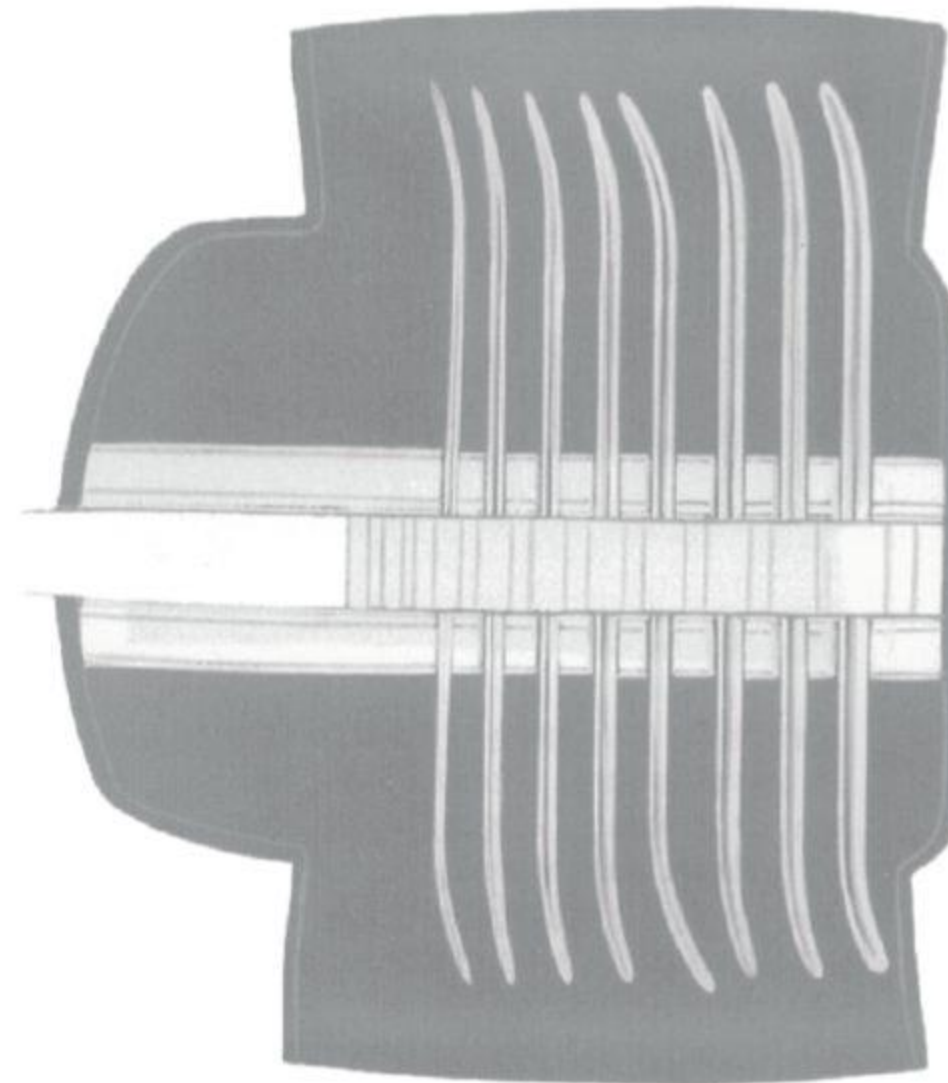

Set
26-6207-00
double ended
29 cm

Tip 4 mm

Uterine Depressor



Sims
 32 cm/12½"

Martin (Simpson)
 32 cm/12½"

Valleix
 26-6214-25
 25 cm/10"

Collin
 26-6215-28
 28 cm/11"

Braun
 26-6216-28
 28 cm/11"

Rigid	cm	cm
	26-6208-32	26-6211-32

Malleable	cm / in	cm / in
	26-6209-32	26-6212-32
	26-6210-32	26-6213-32

Laser Probes



26-6217-01



90°

26-6217-02



45°

26-6217-03



20°

Measuring Probe



26-6218-01

Laser Probe



26-6219-01



90°

26-6219-02



45°

26-6219-03



20°

Depth Ruler

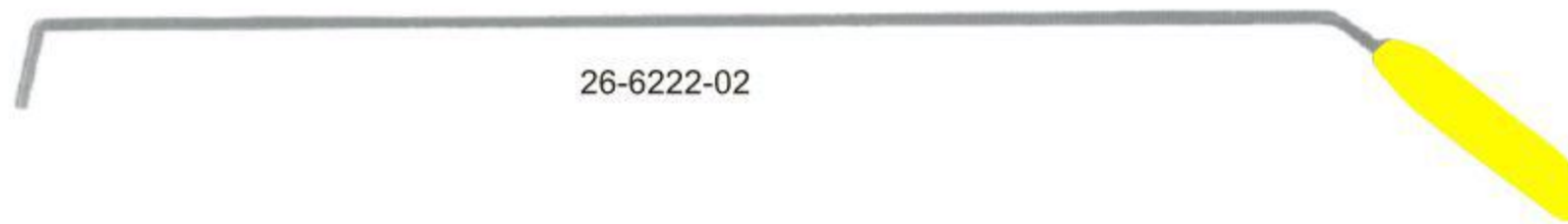

26-6220-01

Measuring Instruments**Hooks**

EN —● Corn Knives, Fistula Hooks, Myoma Instruments

DE —● Konusmesser, Fistelhaken, Myom-instrumente

ES —● Bisturí p. conos de atraccion, Ganchos p. fistulas, instrumentos para fibroma



Ayre
26-6228-23
23 cm/9"



Simon
26-6229-22
22 cm/8¾"



Simon
26-6230-22
22 cm/8¾"



Emmet
22 cm/8¾"



26-6231-01



26-6231-02



26-6231-03



26-6231-04



26-6231-05



Doyen
26-6232-17
17 cm/6¾"



Doyen
26-6233-17
17 cm/6¾"



Segond
26-6234-27
27 cm/10½"

Secretion Spoon



26-6235-27
 27 cm/10½"



Muenchen
 27 cm/10½"



26-6236-04
 4 mm



26-6236-05
 5 mm



Randall
 26-6237-24
 24 cm/9½"

4 mmØ



Novak
 23 cm/9"

- 26-6238-01
1 mm
- 26-6238-02
2 mm
- 26-6238-03
3 mm
- 26-6238-04
4 mm



Novak-Schoeckaert
 26-6239-24
 24 cm/9"



Kevorkian
26-6240-30
30 cm/12"

malleable
26-6241-30
30 cm/12"



Kevorkian
26-6242-30
30 cm/12"

malleable
26-6243-30
30 cm/12"



Townsend
26-6244-30
31 cm/12¼"



malleable
26-6245-30
31 cm/12¼"



Duncan
26-6246-31
31 cm/12¼"



Duncan
26-6247-31
31 cm/12¼"



Goodell
 26-6248-34
 34 cm/13½"



Kogan-Laser
 28 cm/11"



26-6251-28
 28 cm/11"



Kogan
 26-6252-24
 24 cm/9½"



Kogan
 26-6253-24
 24 cm/9½"



Kogan
 28 cm/11"





Martin
26-6256-27
27 cm/10½"



Staude-Moore
26-6257-17
17 cm/6¾"



Barrett
26-6258-18
18 cm/7"



Schroeder
26-6259-25
25 cm/10"



Braun
26-6260-25
25 cm/10"



Collin-Pozzi
26-6261-25
25 cm/10"



Pozzi
26-6262-25
25.5 cm/10¼"

Strong Pattern



Duplay
26-6263-28
28 cm/11"



Skene
 26-6264-24
 24 cm/9½"

Amniotome for the
 amnion Bladder



Beacham
 26-6265-26
 26 cm/10¼"



Czerny
 26-6266-20
 20.5 cm/8¼"



26-6267-26
 26 cm/10¼"



Schroeder
 26-6268-20 20 cm/8"
 26-6268-24 24 cm/9½"

Straight



Schroeder
 26-6269-20
 26-6269-24

Curved on Flat



Schroeder
 26-6270-20
 26-6270-24

Curved Sideway

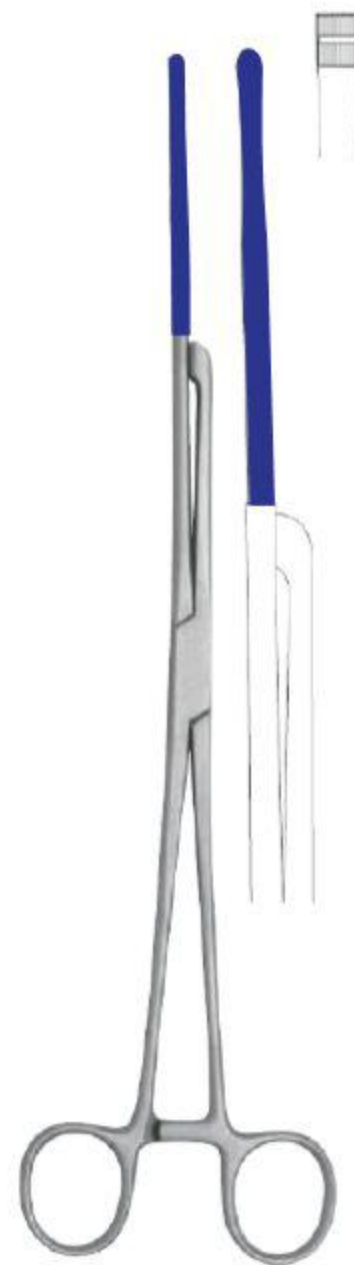

Atrauma
 26-6271-29
 Vulsellum Forcep
 29cm/11 ½"

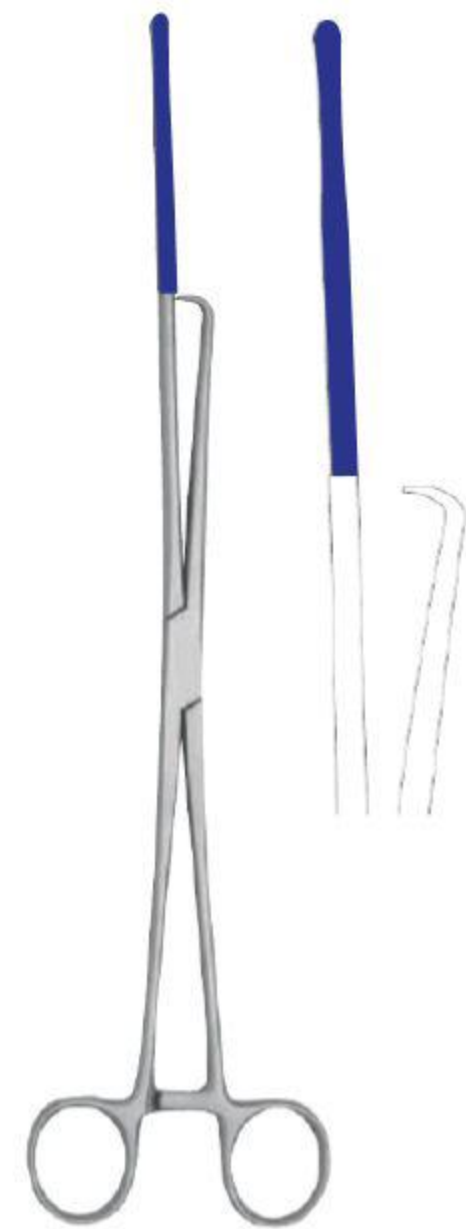

Luer
 26-6272-30
 Vulsellum Forcep
 30.5cm/12"



Atrauma
26-6273-29
29cm/11 1/2"



Bozeman
26-6274-27
27cm/10 1/2"



26-6275-23
23cm/9"
jaw 1/8"

26-6276-23
23cm/9"
jaw 1/4"



Rotunda
26-6277-27
27cm/10 1/2"



Bierer
26-6278-24
24cm/9 1/2"



Straight
26-6279-06
26-6279-08
26-6279-10



Museux
24 cm/9 1/2"
06 mm
08 mm
10 mm



Curved Sideway
26-6280-06
26-6280-08
26-6280-10



Straight
26-6281-06
26-6281-08
26-6281-10



Museux
24 cm/9 1/2"
06 mm
08 mm
10 mm



Curved Sideway
26-6282-06
26-6282-08
26-6282-10



Braun
26-6283-16
16 cm/6 1/4"

For the amnion Bladder



Pratt
 26-6284-28
 28 cm/11"



Teale
 26-6285-24
 24 cm/9½"



Iowa
 26-6286-26
 26 cm/10¼"



Jacobs
 Straight Curved Sideway
 26-6287-21 26-6288-21
 21 cm/8¼"



Bonney Polypus
 26-6289-26
 24 cm/9 ½"



Kelly
 26-6290-32
 32 cm/12½"



Heywood-Smith
 26-6291-20
 20 cm/8"



Heywood-Smith
 26-6292-25
 25 cm/10"



Noto
 26-6293-27
 27 cm/10½"

EN —● Uterine Elevating, Ovarian Forceps, Vaginal Clamps

DE —● Uterus-Faßzangen

ES —● Pinzas para el útero



Dartigues
26-6294-27
27 cm/10½"



Somer
26-6295-23
23 cm/9"



Collin
26-6296-25
25 cm/10"



Ovarian Forceps

Doyen
26-6297-18 18 cm/7"
26-6297-20 20 cm/8"



Bonney
26-6298-34
34.5 cm/13 ½"



Bonney
26-6299-27
27 cm/10½"



Bonney
26-6300-20
20 cm/8"
curved



Bonney Berkley
26-6301-20
20 cm/8"
angled



Gellhorn
 26-6302-23
 23 cm/9"



Thoms-Gaylor
 26-6303-24
 24 cm/9½"



Schubert
 26-6304-21 21 cm/8¼"
 26-6304-29 29 cm/11¼"



Schubert
 26-6305-26
 26 cm/10¼"



Tischler
 26-6306-27
 27 cm/10½"



Van Doren
 26-6307-25
 25 cm/10"

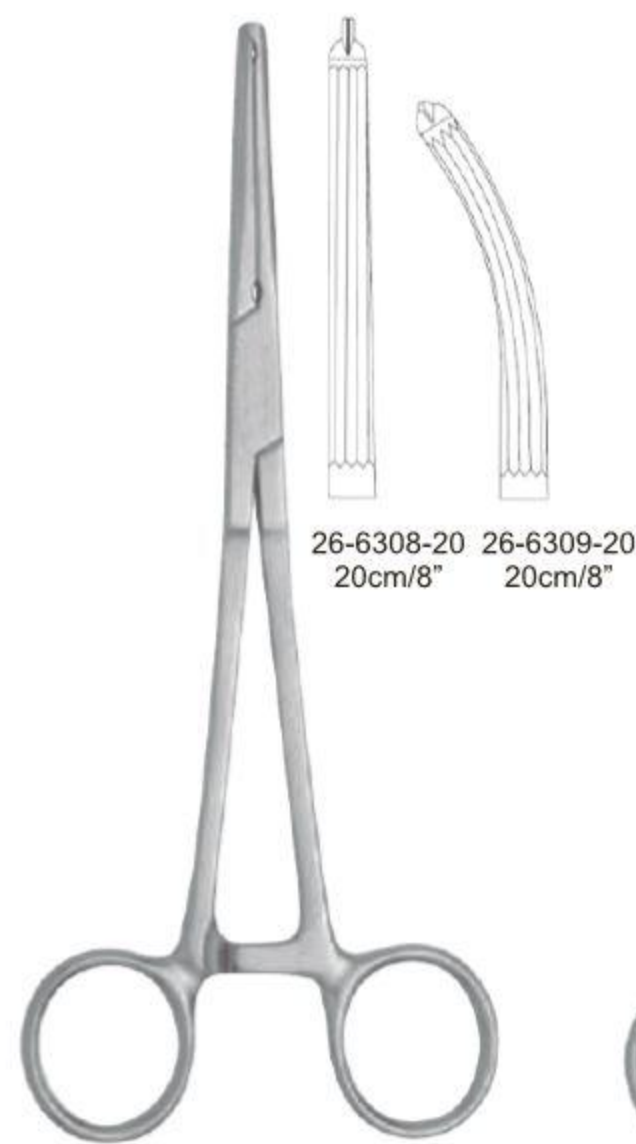

Gwilliam

26-6308-20 20cm/8"
 26-6309-20 20cm/8"



Hunter
 26-6310-23
 23 cm/9"

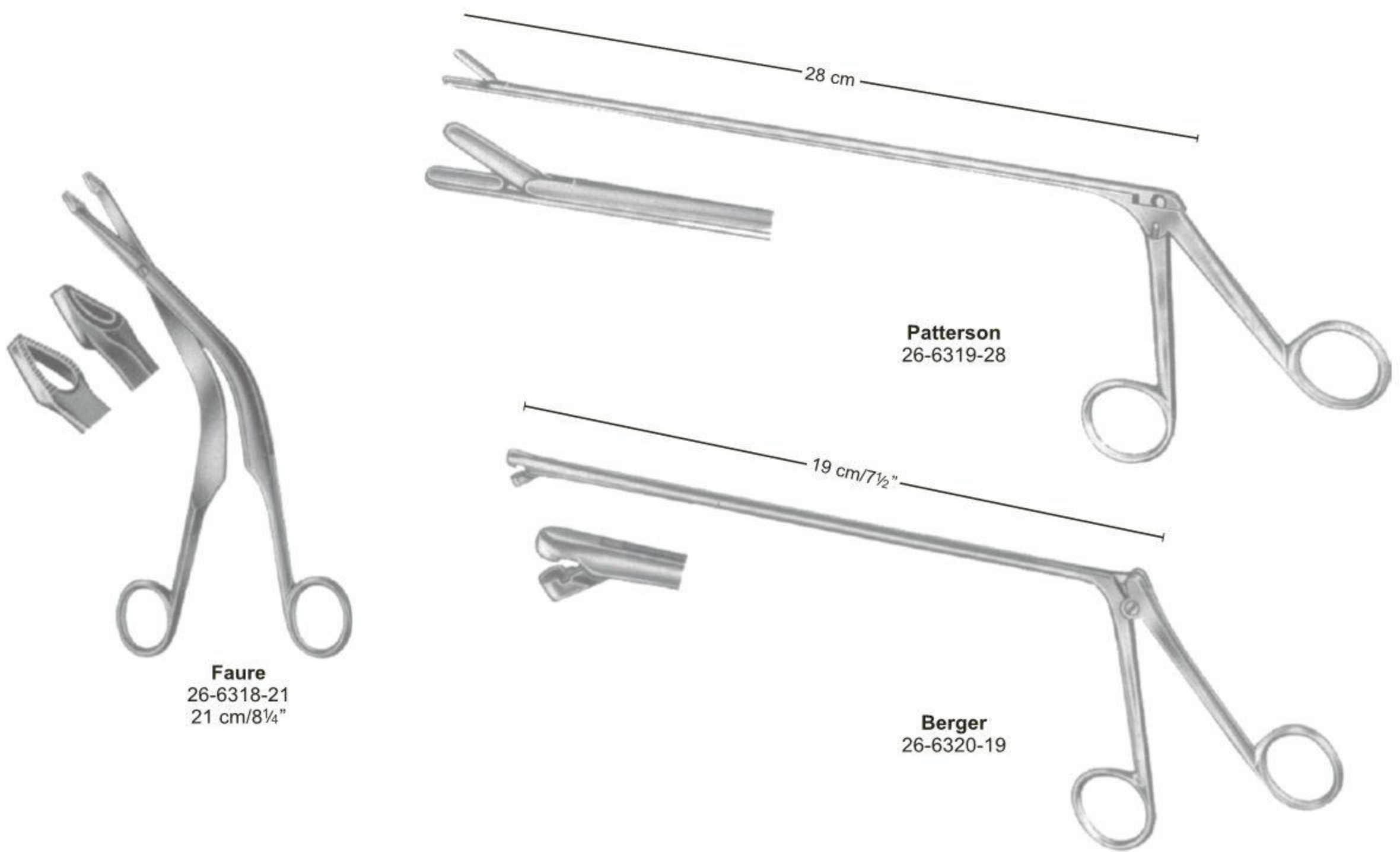
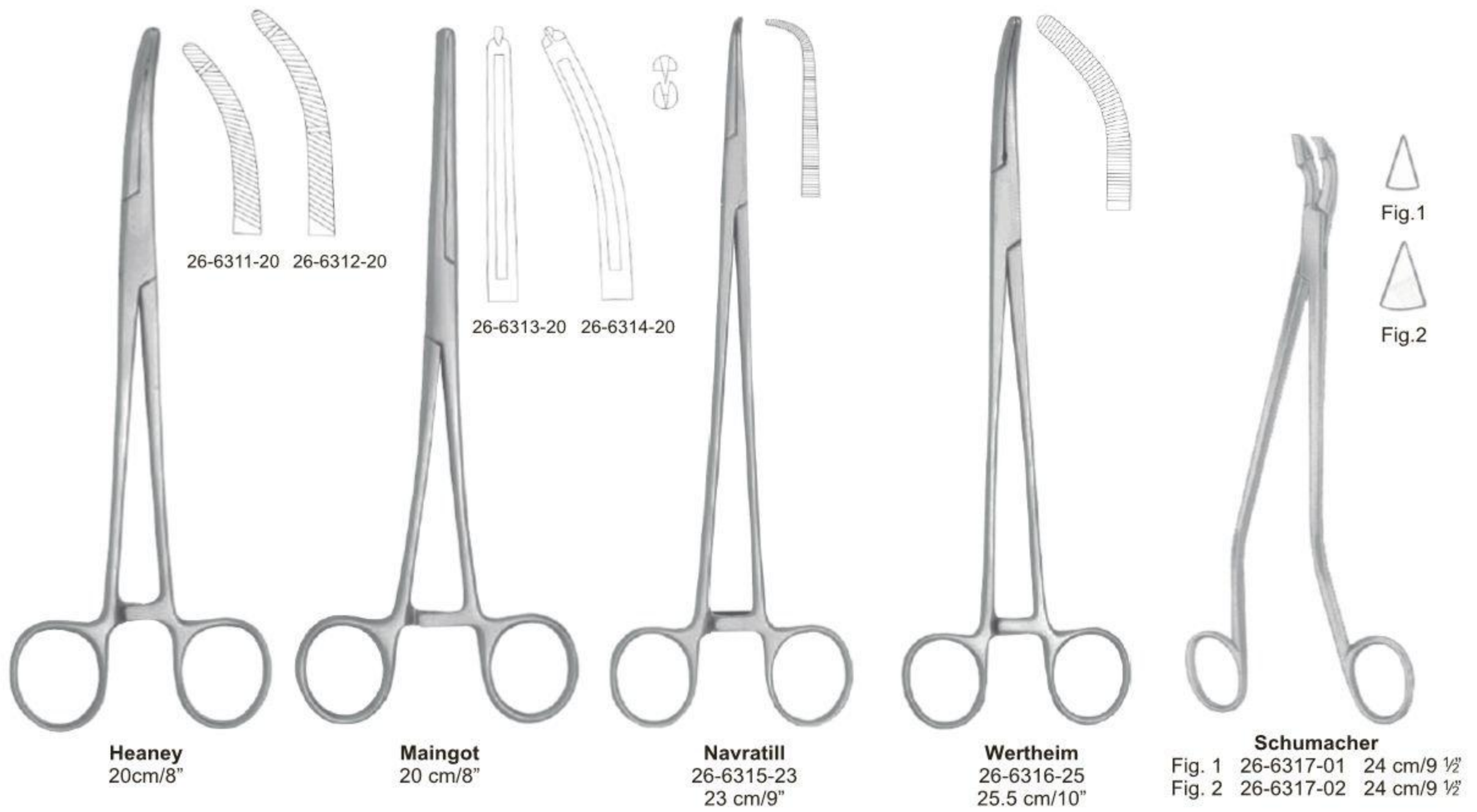



- 26-6321-20 L= 20 cm/8"
- 26-6321-25 L= 25 cm/10"
- 26-6321-30 L= 30 cm/12"
- 26-6321-35 L= 35 cm/14"
- 26-6321-40 L= 40 cm/16"



- 26-6323-04 4 mm
- 26-6323-06 6 mm

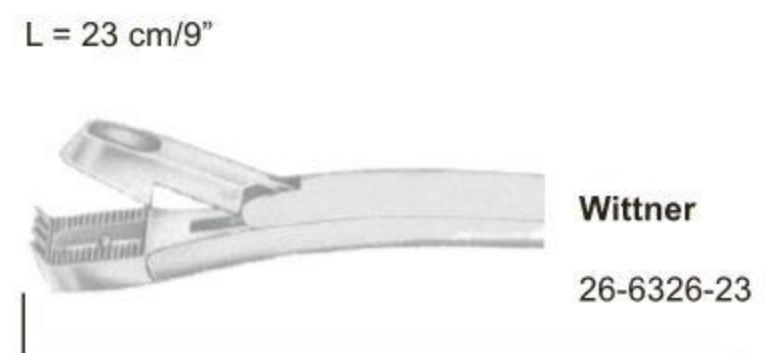
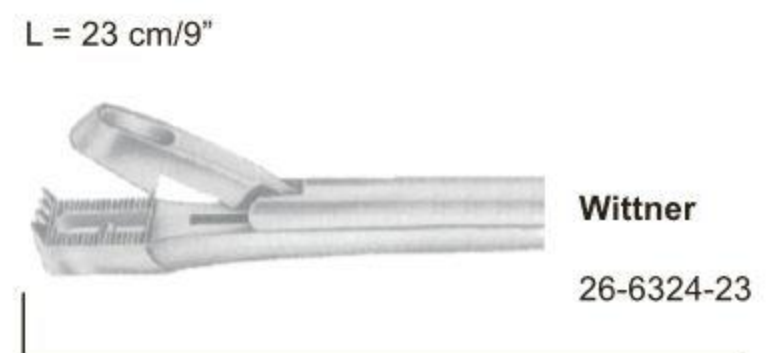

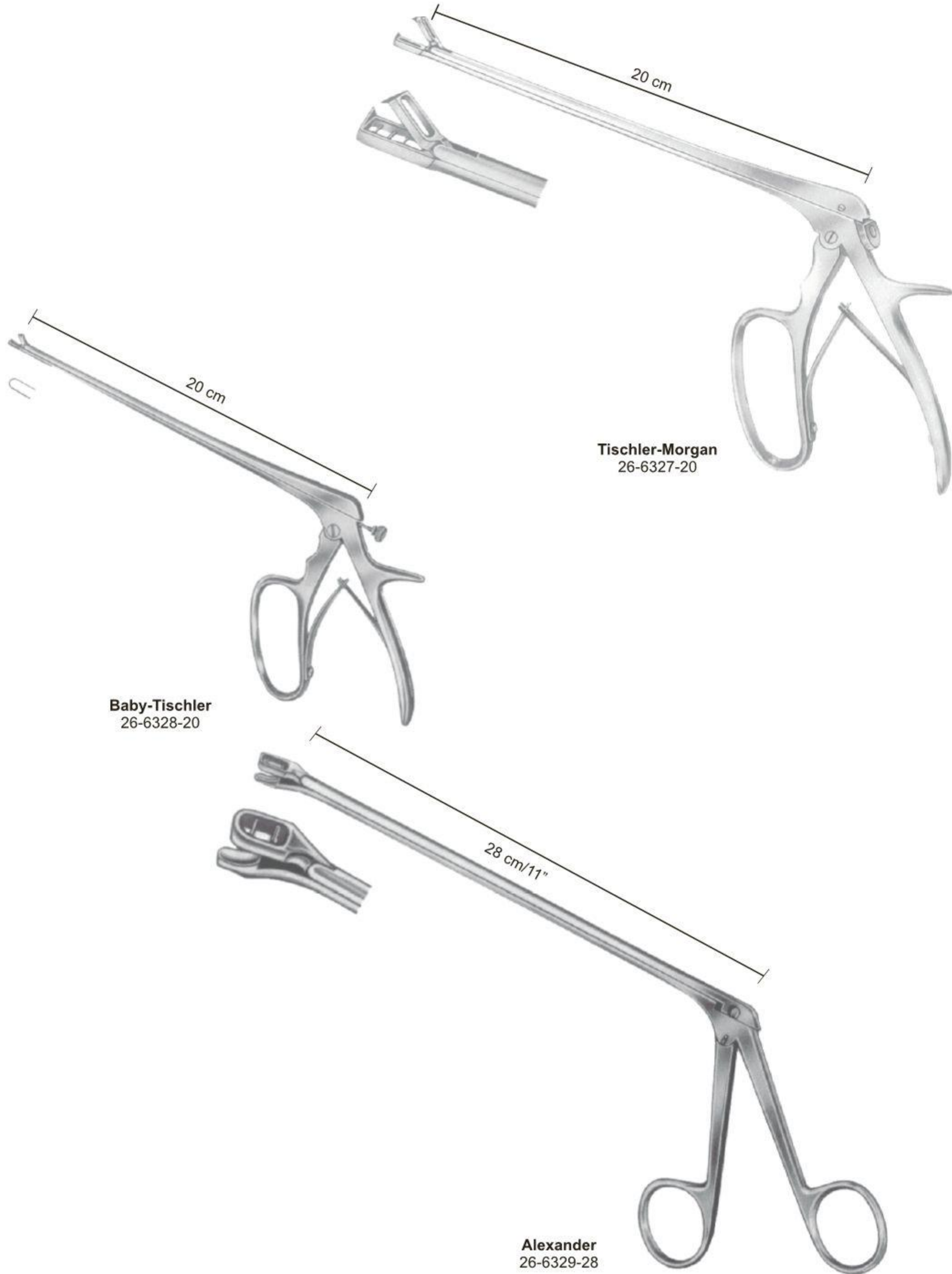

Cervical Biopsy and Specimen Forceps ● EN
 Probeexzisionszangen ● DE
 Pinzas saca-bocados para biopsia ● ES

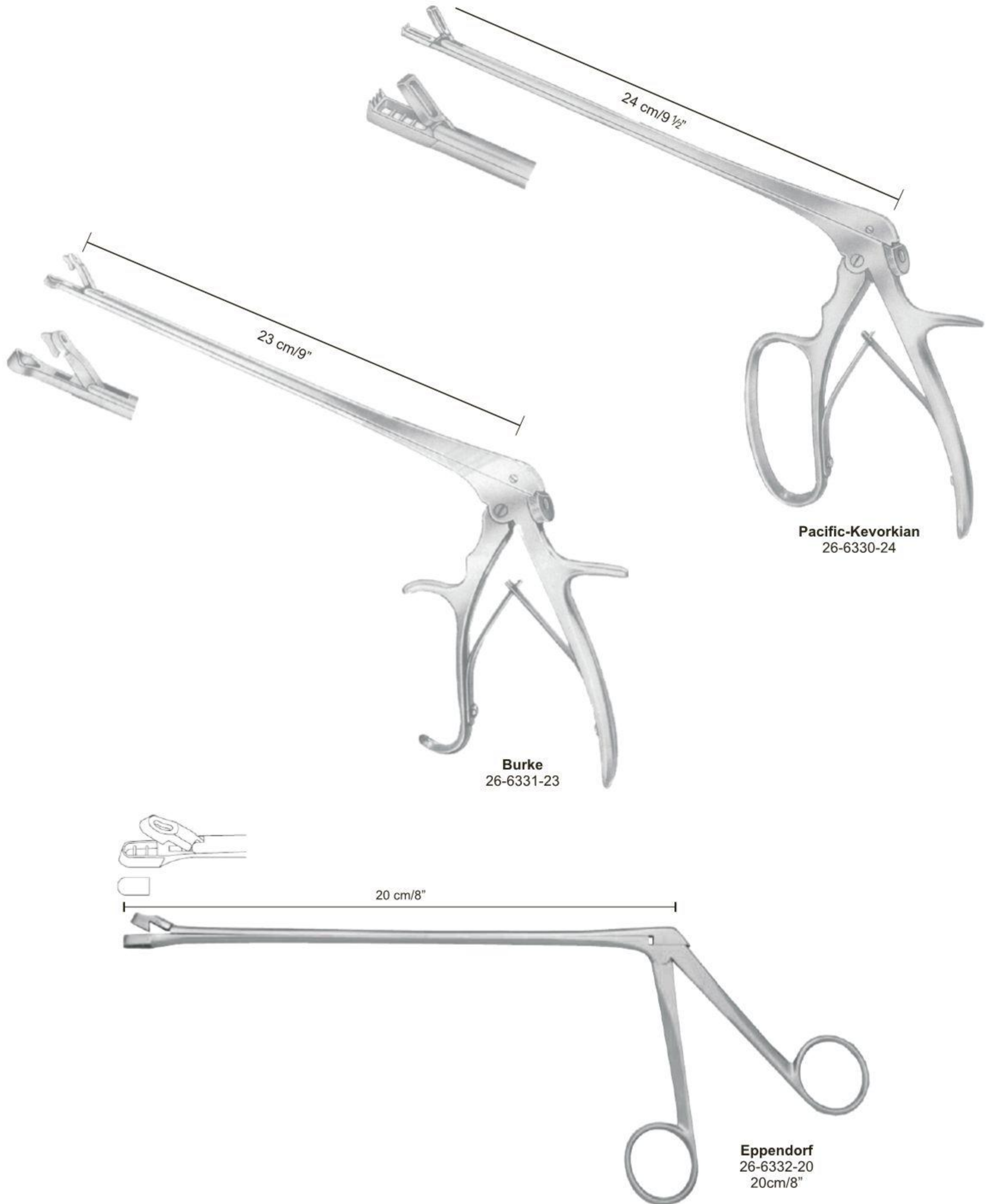











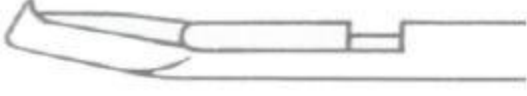

Townsend

Handle

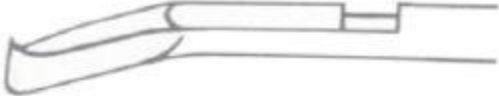

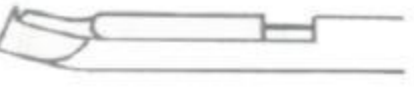
Tip with tube

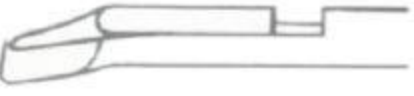
		Complete instrument	Tip, only
	Tischler	26-6333-00	26-6334-01
	Kevorkian	26-6335-00	26-6336-01
	Mini-Townsend	26-6337-00	26-6338-01
 	Tischler-up	26-6339-00	26-6340-01
 	Tischler-down	26-6341-00	26-6342-01
 	Mini-Townsend-up	26-6343-00	26-6344-01
 	Mini-Townsend-down	26-6345-00	26-6346-01

Uterine Curettes ●— EN
 Uterusküretten ●— DE
 Curetas uterinas ●— ES



Schroeder
30 cm/12"

Sharp Rigid

Schroeder
Simon



Fig. 1
26-6347-01
26-6348-01



Fig. 2
26-6349-02
26-6350-02



Fig. 3
26-6351-03
26-6352-03



Schroeder
Simon
Fig. 4
26-6353-04
26-6354-04



Fig. 5
26-6355-05
26-6356-05



Fig. 6
26-6357-06
26-6358-06



Simon
25 cm/10"



Gourdet
28 cm/11"



Fig. 1
26-6359-01
6 mm



Fig. 2
26-6359-02
8 mm



Fig. 3
26-6359-03
10 mm



Fig. 4
26-6359-04
12 mm



Fig. 5
26-6359-05
14 mm



Thomas



Fig. 1
26-6360-01



Fig. 2
26-6360-02



Fig. 3
26-6360-03



Fig. 4
26-6360-04



Fig. 5
26-6360-05



Fig. 6
26-6360-06



Greene

26-6361-10
10 mm

26-6361-12
12 mm

26-6361-14
14 mm



Collin
26-6362-30
30 cm/12"



Heaney
26-6363-24
24 cm/9½"



Heaney
26-6364-24
24 cm/9½"



Milan
 28.5 cm/11¼"

Malleable



26-6365-05
 5 mm Ø



26-6367-07
 7 mm Ø



26-6369-09
 9 mm Ø

Rigid

26-6366-05
 5 mm Ø

26-6368-07
 7 mm Ø

26-6370-09
 9 mm Ø



28 cm/11"

Hose Connecting Piece



26-6372-00

	Ø
26-6371-04	4.0 mm
26-6371-06	6.0 mm
26-6371-08	8.0 mm
26-6371-10	10.0 mm
26-6371-12	12.0 mm
26-6371-14	14.0 mm
26-6371-16	16.0 mm

EN —● Uterine Curettes
DE —● Uterusküretten
ES —● Curetas uterinas

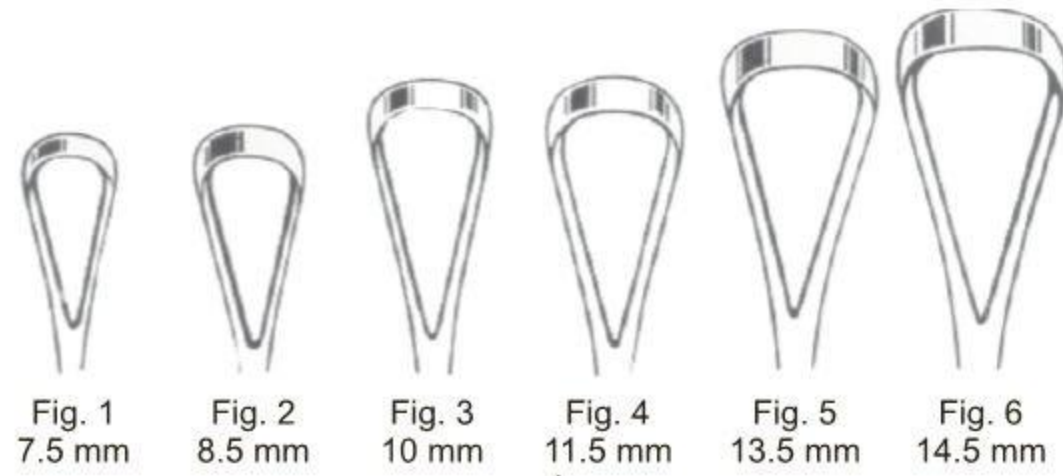

		Malleable		Rigid	
		Sharp	Blunt	Sharp	Blunt
Fig. 1	26-6373-01	26-6374-01		26-6375-01	26-6376-01
Fig. 2	26-6373-02	26-6374-02		26-6375-02	26-6376-02
Fig. 3	26-6373-03	26-6374-03		26-6375-03	26-6376-03
Fig. 4	26-6373-04	26-6374-04		26-6375-04	26-6376-04
Fig. 5	26-6373-05	26-6374-05		26-6375-05	26-6376-05
Fig. 6	26-6373-06	26-6374-06		26-6375-06	26-6376-06

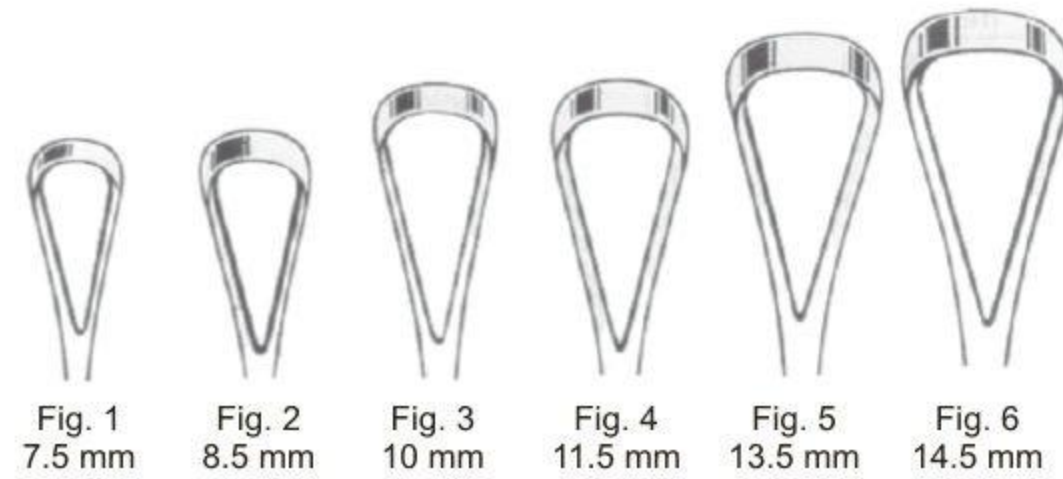

		Malleable		Rigid	
		Sharp	Blunt	Sharp	Blunt
Fig. 1	26-6377-01	26-6378-01		26-6379-01	26-6380-01
Fig. 2	26-6377-02	26-6378-02		26-6379-02	26-6380-02
Fig. 3	26-6377-03	26-6378-03		26-6379-03	26-6380-03
Fig. 4	26-6377-04	26-6378-04		26-6379-04	26-6380-04
Fig. 5	26-6377-05	26-6378-05		26-6379-05	26-6380-05
Fig. 6	26-6377-06	26-6378-06		26-6379-06	26-6380-06

Uterine Currettes ●— EN
 Uterusküretten ●— DE
 Curetas uterinas ●— ES

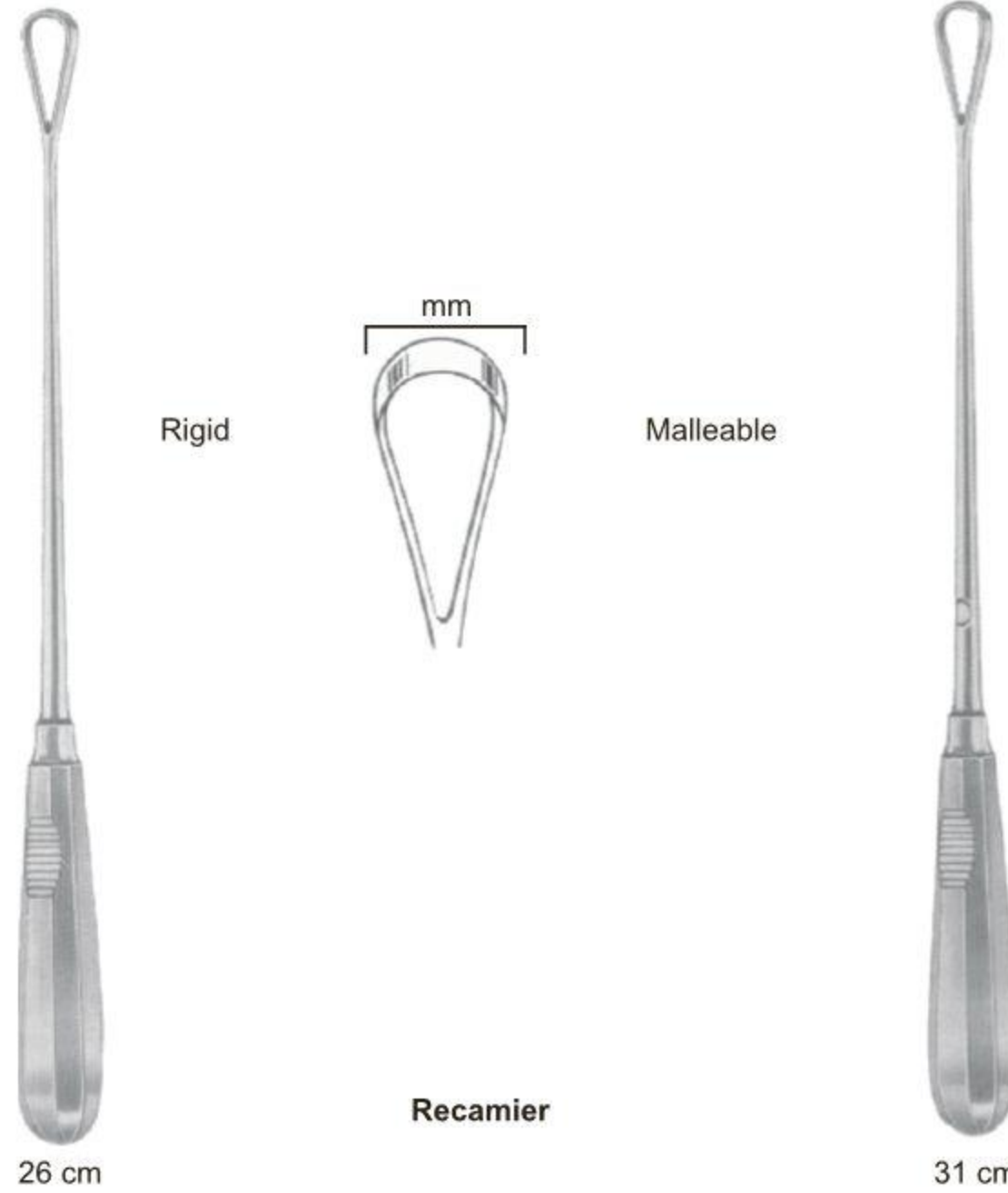

Fig.	mm	Malleable		Rigid		Malleable		Rigid	
		Sharp	Blunt	Sharp	Blunt	Sharp	Blunt	Sharp	Blunt
00	5	26-6381-05	26-6382-05	26-6383-05	26-6384-05	26-6385-05	26-6386-05	26-6387-05	26-6388-05
0	6	26-6381-06	26-6382-06	26-6383-06	26-6384-06	26-6385-06	26-6386-06	26-6387-06	26-6388-06
1	7	26-6381-07	26-6382-07	26-6383-07	26-6384-07	26-6385-07	26-6386-07	26-6387-07	26-6388-07
2	8	26-6381-08	26-6382-08	26-6383-08	26-6384-08	26-6385-08	26-6386-08	26-6387-08	26-6388-08
3	9	26-6381-09	26-6382-09	26-6383-09	26-6384-09	26-6385-09	26-6386-09	26-6387-09	26-6388-09
4	10	26-6381-11	26-6382-11	26-6383-11	26-6384-11	26-6385-11	26-6386-11	26-6387-11	26-6388-11
5	12	26-6381-12	26-6382-12	26-6383-12	26-6384-12	26-6385-12	26-6386-12	26-6387-12	26-6388-12
6	14	26-6381-14	26-6382-14	26-6383-14	26-6384-14	26-6385-14	26-6386-14	26-6387-14	26-6388-14
7	15	26-6381-15	26-6382-15	26-6383-15	26-6384-15	26-6385-15	26-6386-15	26-6387-15	26-6388-15
8	16	26-6381-16	26-6382-16	26-6383-16	26-6384-16	26-6385-16	26-6386-16	26-6387-16	26-6388-16
9	19	26-6381-19	26-6382-19	26-6383-19	26-6384-19	26-6385-19	26-6386-19	26-6387-19	26-6388-19
10	20	26-6381-20	26-6382-20	26-6383-20	26-6384-20	26-6385-20	26-6386-20	26-6387-20	26-6388-20
11	21	26-6381-21	26-6382-21	26-6383-21	26-6384-21	26-6385-21	26-6386-21	26-6387-21	26-6388-21
12	23	26-6381-23	26-6382-23	26-6383-23	26-6384-23	26-6385-23	26-6386-23	26-6387-23	26-6388-23
13	25					26-6385-25	26-6386-25	26-6387-25	26-6388-25
14	30					26-6385-30	26-6386-30	26-6387-30	26-6388-30
15	35					26-6385-35	26-6386-35	26-6387-35	26-6388-35
16	40					26-6385-40	26-6386-40	26-6387-40	26-6388-40



Bumm
max. 29 cm/11½"

Fig.	mm	Mealleable	
		Sharp	Blunt
0	16.0	26-6389-16	26-6390-16
1	18.0	26-6389-18	26-6390-18
2	19.5	26-6389-19	26-6390-19
3	21.5	26-6389-21	26-6390-21
4	23.5	26-6389-23	26-6390-23
5	26.0	26-6389-26	26-6390-26
6	28.5	26-6389-28	26-6390-28



Blunt

Sharp

Blake (Zweifel)
26-6391-27 27 cm/10½"
26-6391-31 31 cm/12¼"



Zeppelin Scissor with TC

slightly curved
26-6392-23
23cm/9"
26-6392-26
26.5cm/10 1/2"
26-6392-30
30cm/12"

curved
26-6393-23
23cm/9"
26-6393-26
26.5cm/10 1/2"
26-6393-30
30cm/12"

Fully curved
26-6394-23
23cm/9"
26-6394-26
26.5cm/10 1/2"
26-6394-30
30cm/12"



Straight Slightly Curved Strongly Curved Angled

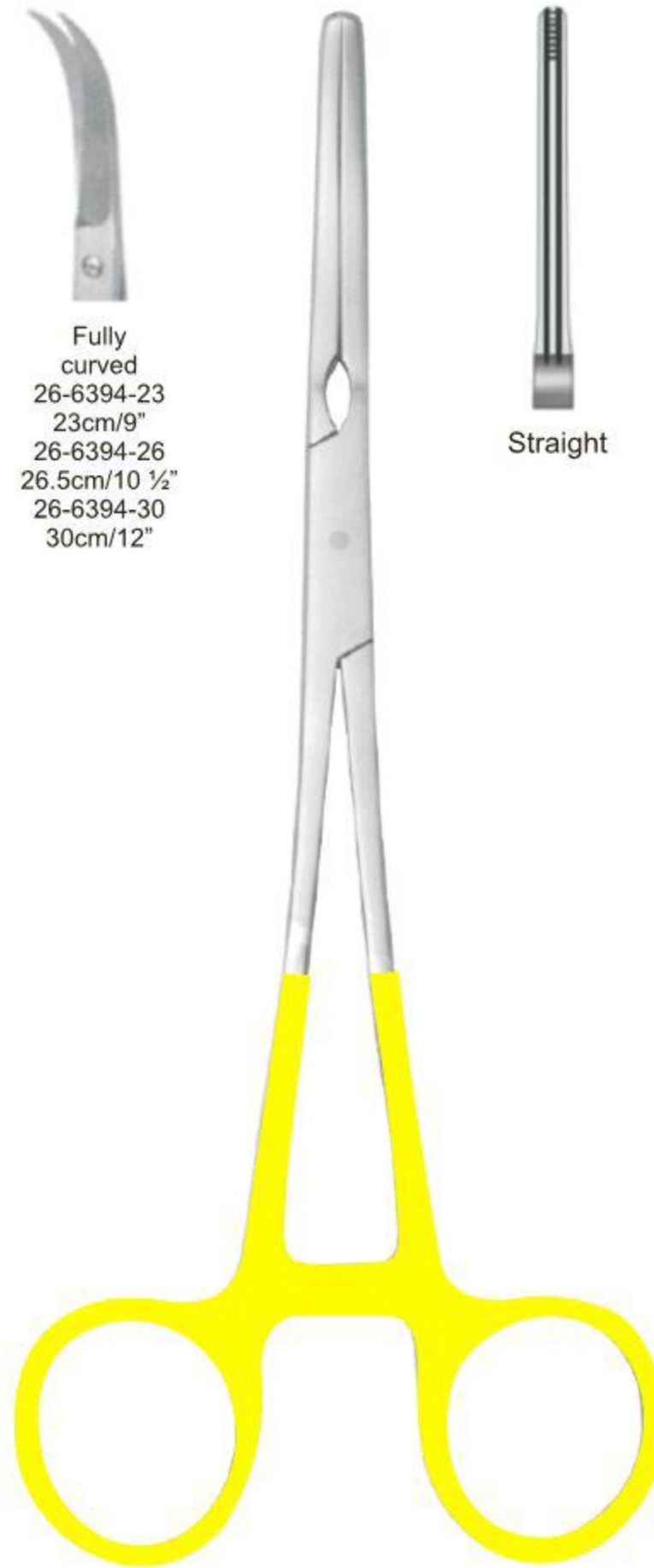

Zeppelin Clamps

offset handle with gold rings (without TC)

Straight	26-6395-21	26-6399-24	26-6403-30	26-6407-35
Slightly Curved	26-6396-21	26-6400-24	26-6404-30	26-6408-35
Strongly Curved	26-6397-21	26-6401-24	26-6405-30	26-6409-35
Angled	26-6398-21	26-6402-24	26-6406-30	26-6410-35
	21.5cm/8 1/2"	24cm/9 1/2"	30cm/12"	35cm/14"



Zeppelin Clamps

Straight Handle with gold rings (without TC)

Straight	26-6411-21	26-6415-24	26-6419-30	26-6423-35
Slightly Curved	26-6412-21	26-6416-24	26-6420-30	26-6424-35
Strongly Curved	26-6413-21	26-6417-24	26-6421-30	26-6425-35
Angled	26-6414-21	26-6418-24	26-6422-30	26-6426-35
	21.5cm/8 1/2"	24cm/9 1/2"	30cm/12"	35cm/14"

EN Obstetrics

DE Geburtshilfe

ES Obstetricia

Page 559 to 565



For Internal Measurements



27-6501-45
Laparotomy Ring
1¾" Inside Diameter



De Lee
27-6502-20
20 cm/8"
cm/Inch Scale



Martin
27-6503-34 34 cm/13½" 27-6504-34
cm Scale cm/Inch Scale



Collin
27-6505-35
35 cm/13¾"
cm Scale



Breisky
27-6506-33
33 cm/13"
cm Inch Scale



Collyer
27-6507-30
30 cm/12"
cm Inch Scale



Iowa
27-6508-14
14 cm/5½"
Trumpet Needle Guide



Winter
 28 cm/11"



Wallich
 27-6511-42
 42 cm/16¾"



Sanger
 21 cm/10½"

Straight
 27-6512-27

Curved
 27-6513-27

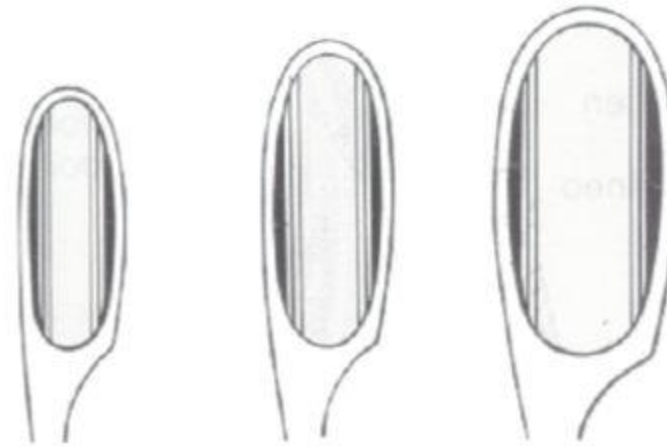

Straight 27-6509-01 27-6509-02 27-6509-03

Curved 27-6510-01 27-6510-02 27-6510-03

Uterine Haemostasis Forceps



Green-Armytage
 27-6514-21
 21 cm/8¼"

- EN —● Scalp flap forceps, perforators and elevating spoons
- DE —● Kopfschwartzangen, Geburtslöffel
- ES —● Pinza para pericráneo, separador para la salida de cabeza

Scalp Flap Forceps



Gauss
27-6515-26
26 cm/10¼"



Willet-Martel
27-6516-19
19 cm/7½"

Head Lever



Murless
27-6517-26
26 cm/10¼"

Elevating Spoon



Sellheim
27-6518-28
28 cm/11"



Smellie
27-6519-25
25 cm/10"

Perforators



Nagele
27-6520-25
25 cm/10"

Cranioclast



Braun
27-6521-42
42 cm/16½"

Basiotribe



Tarnier
27-6522-46
46 cm/18"

Decapitating Hook



Braun
27-6523-30
30 cm/12"

Umbilical Cord Clamps



Collin
27-6524-09
9 cm/3½"



Nagele
27-6525-36 36 cm/14"
27-6525-40 40 cm/16"



Wrigley
27-6526-28
28 cm/11"



Simpson
27-6527-23
23 cm/9"



Simpson
27-6528-28 28cm/11"
27-6528-38 38cm/15"



Simpson-Braun
27-6529-36
36 cm/14"



Simpson-Luikart
27-6530-36
36 cm/14"

Obstetrical Forceps ●— EN
 Geburtszangen ●— DE
 Forceps obstétricos ●— ES



De Lee
 27-6531-30 30 cm/12"
 27-6532-36 36 cm/14"

Traction Handles to be
 used with all obstetrical
 Forceps with Standard type Handles



Bill
 27-6533-20



Kielland
 27-6534-41
 41 cm/16"



Kielland-Luikart
 27-6535-40
 40 cm/15¾"



Mclean
 27-6536-36
 36 cm/14"



Elliot
27-6537-32 32 cm/12½"
27-6538-38 38 cm/15"



Piper
27-6539-44
44 cm/17¼"



With Traction Handle

Barnes-Neville
27-6540-43
43.5 cm/17"



With Traction Handle

Tarnier
27-6541-40
40 cm/15¾"

- EN** Sterilization
- DE** Sterilisation
- ES** Esterilización

Page 566 to 567





CHEATLE
28-6601-27 27.0cm

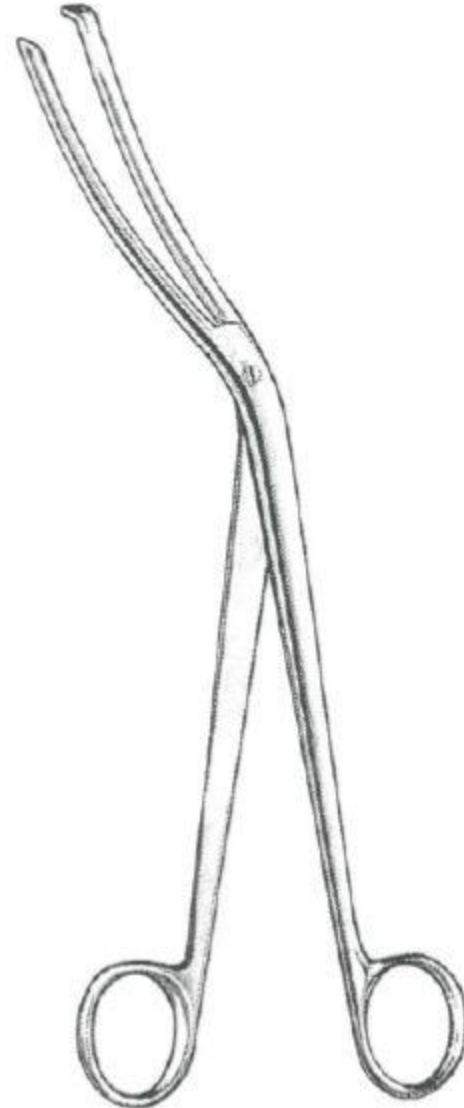

CHEATLE
28-6602-27 26.5cm



CHEATLE
28-6603-28 28.0cm



28-6604-20 20.0cm
28-6604-30 30.0cm

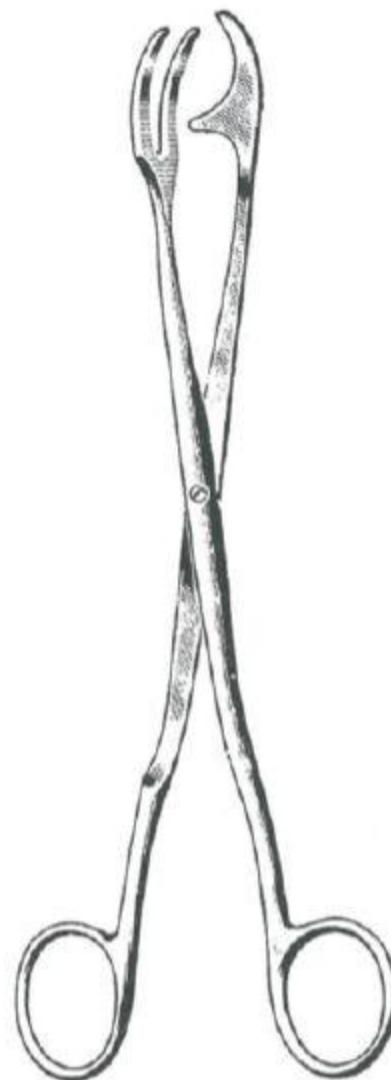

ROGGE
28-6605-23 23.0cm



DAVIS
28-6606-16 16.0cm
28-6606-20 20.0cm
28-6606-24 24.0cm

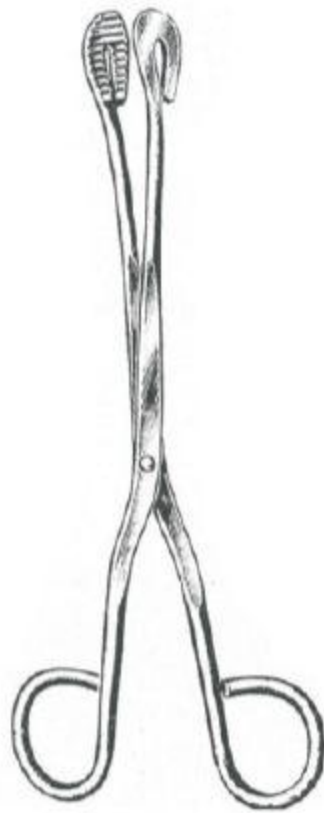

UNIVERSAL
 28-6607-20 20.0cm
 28-6607-28 28.0cm

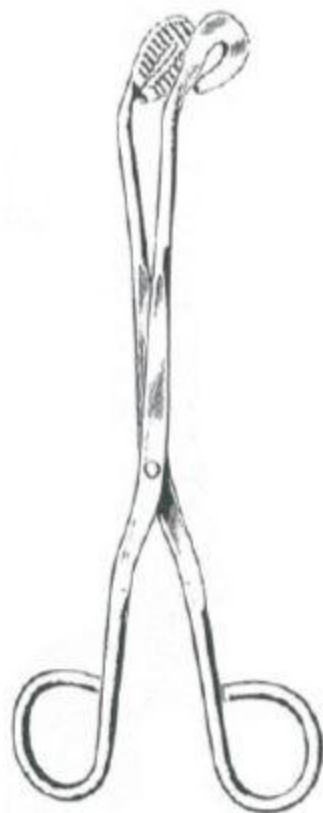

UNIVERSAL
 28-6608-20 20.0cm
 28-6608-28 28.0cm



PYE-SMITH (HARRISON)
 28-6609-25 25.0cm
 28-6609-30 30.0cm



HARRISON
 28-6610-25 25.0cm
 28-6610-30 30.0cm
 28-6610-35 35.0cm
 28-6610-45 45.0cm

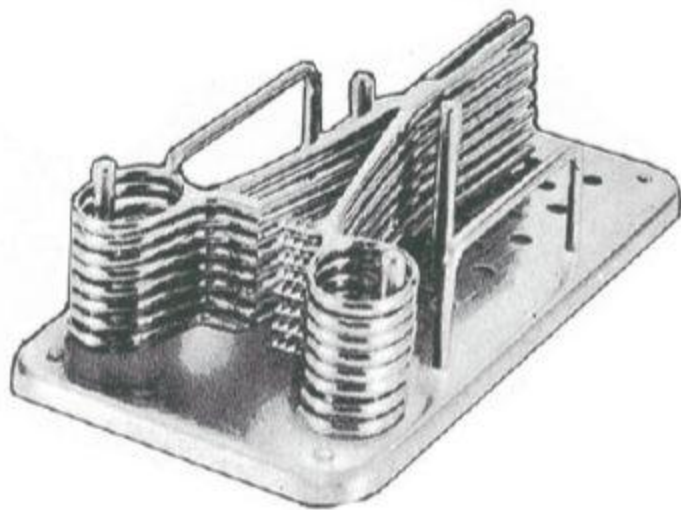

28-6611-00



BUNT
 28-6612-12 12.0cm



MAYO
 28-6613-10 10.0cm
 28-6613-12 12.0cm
 28-6613-14 14.0cm
 28-6613-15 15.0cm



MAYO
 28-6614-14 14.0cm

EN Asepsis

DE Asepsis

ES Asepsia

Page 568 to 559





cm	in	
11	4½"	29-6701-11
13	5	29-6701-13
14	5½"	29-6702-14
16	6¼"	29-6702-16



cm	in	
11	4½"	29-6704-11
13	5	29-6704-13
14	5½"	29-6703-14
15	6"	29-6703-15

Nail Scissor, Cuticle Scissor, Cuticle Nipper, Nail Nippers ● EN
 Nagelscheren, Hautscheren, Nagelhautzangen, Nagelzangen ● DE
 Tijeras para uñas, Pinjas y tijeras cuticulares, Pinzas corta-uñas ● ES

Stainless

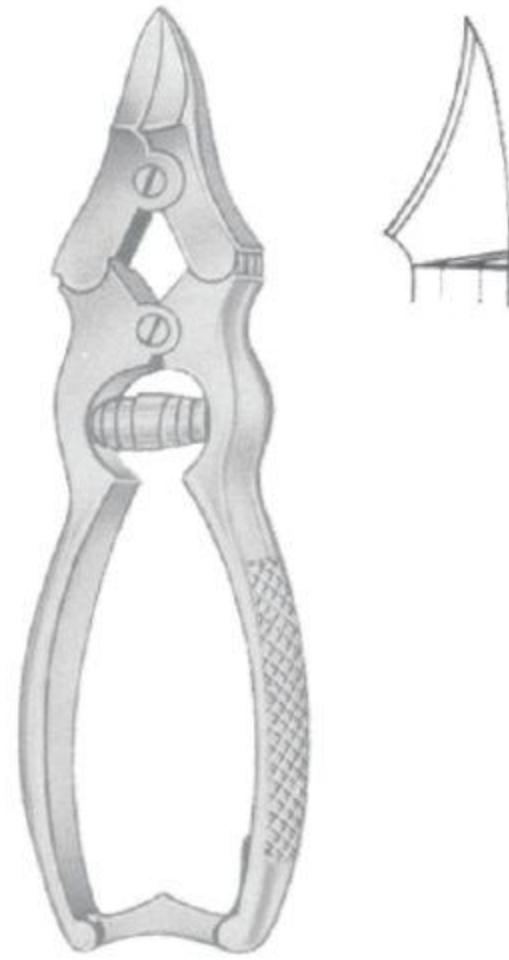

29-6705-15
15 cm/6"



29-6706-10
29-6706-10
10 cm/4"



Straight
Curved

29-6707-10
29-6707-10
10 cm/4"



29-6708-10
10 cm/4"



29-6709-11
11 cm/4½"
29-6709-13
13 cm/5"

EN Hollowware

DE Hollowware

ES Hollowware

Page 570 to 575



- EN —● Needle Case, Endodontic Box, Tube Rack, Cotton Holder, Sprit Lamp, Cup, Fennle and Jars
- DE —● Needle Case, Endodontie Box, Tube Rack, Cotton Holder, Sprit Lamp, Cup, Fennle und Jars
- ES —● Caso aguja, Caja de endodoncia, bastidor de tubo, titular de algodón, la lámpara Espiritu la Copa, Fennle y tarros



Needle Case Round with Cover
30-6801-01 65x15mm



Needle Case Round
30-6802-01 80x20mm



Needle Case Rectangle
30-6803-01 70x70x10mm



Endodontic Box
30-6804-01
100x40x50mm

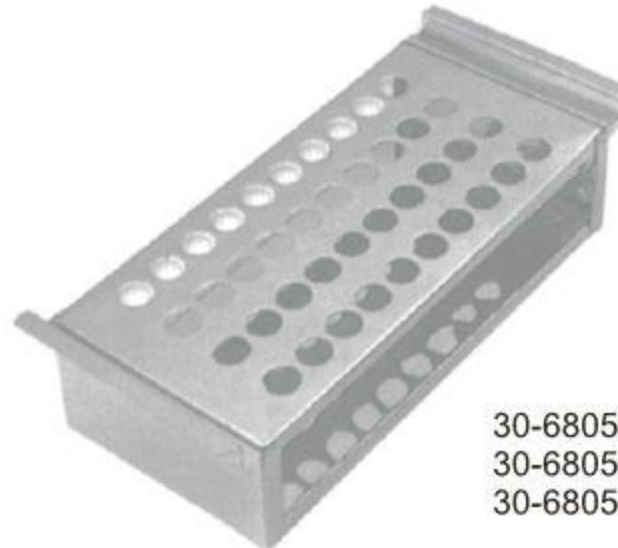

Tube Rack

- 30-6805-01 6.35x15.25x5cm for 12 tubes
- 30-6805-02 6.35x17.75x7.5cm for 27 tubes
- 30-6805-03 7.50x17.75x6.35cm for 36 tubes



Sprit Lamp
30-6806-01
Standard Size



Sprit Lamp
30-6807-01
Standard Size



Sputum Cup

- 30-6808-01 75x80mm
- 30-6808-02 100x50mm
- 30-6808-03 100x80mm



Dressing Jar

- | | | |
|------------|-----------|------------|
| 30-6809-01 | 80x60mm | 30-6810-01 |
| 30-6809-02 | 80x80mm | 30-6810-02 |
| 30-6809-03 | 100x100mm | 30-6810-03 |
| 30-6809-04 | 120x120mm | 30-6810-04 |
| 30-6809-05 | 150x150mm | 30-6810-05 |
| 30-6809-06 | 180x180mm | 30-6810-06 |
| 30-6809-07 | 200x200mm | 30-6810-07 |



Dressing Jar



Fennle

- 30-6812-01 100mm Ø
- 30-6812-02 120mm Ø
- 30-6812-03 150mm Ø
- 30-6812-04 200mm Ø



Cotton Holder
30-6811-01



Cotton Holder
30-6811A-01



Jars, Jallipot, Bowls, Cups, Kidney Trays ● EN
 Jars, Jallipot, Schalen, Becher, Kidney Trays ● DE
 Frascos, Jallipot, tazones, tazas, bandejas de riñón ● ES

**Forceps Jar**

30-6813-01	30x90mm
30-6813-02	50x125mm
30-6813-03	50x170mm
30-6813-04	50x200mm
30-6813-05	40x230mm
30-6813-06	70x110mm
30-6813-07	80x150mm
30-6813-08	100x200mm
30-6813-09	150x30mm

**Medicine Cup**

30-6816-01	50ml
30-6816-02	60ml
30-6816-03	70ml

**Kick Bucket with Trolley**

30-6819-01	390x280x180mm
------------	---------------

**Gallipot**

30-6814-01	01 oz	30-6814-09	09 oz
30-6814-02	02 oz	30-6814-10	10 oz
30-6814-03	03 oz	30-6814-11	11 oz
30-6814-04	04 oz	30-6814-12	12 oz
30-6814-05	05 oz	30-6814-13	13 oz
30-6814-06	06 oz	30-6814-14	14 oz
30-6814-07	07 oz	30-6814-15	15 oz
30-6814-08	08 oz	30-6814-16	16 oz

**Lotion Bowl without spout**

30-6817-01	40x19mm	30-6817-08	150x65mm
30-6817-02	50x25mm	30-6817-09	180x85mm
30-6817-03	60x30mm	30-6817-10	200x100mm
30-6817-04	80x40mm	30-6817-11	250x120mm
30-6817-05	100x50mm	30-6817-12	300mm
30-6817-06	120x60mm	30-6817-13	350mm
30-6817-07	140x60mm	30-6817-14	400mm

**Spong Bowl**

30-6815-01	12 cm
30-6815-02	15 cm
30-6815-03	20 cm

**Wash Basin**

30-6818-01	300x80mm
30-6818-02	320x85mm
30-6818-03	330x90mm
30-6818-04	350x110mm
30-6818-05	400x115mm

**Kidney Tray**

30-6821-01	12cm
30-6821-02	15cm
30-6821-03	18cm
30-6821-04	20cm
30-6821-05	25cm
30-6821-06	28cm
30-6821-07	30cm

**Kidney Tray Shallow**

30-6820-01	17cm
30-6820-02	22cm
30-6820-03	24cm

**Kidney Tray (with cover)**

30-6822-01	15cm
30-6822-02	20cm
30-6822-03	25cm
30-6822-04	30cm

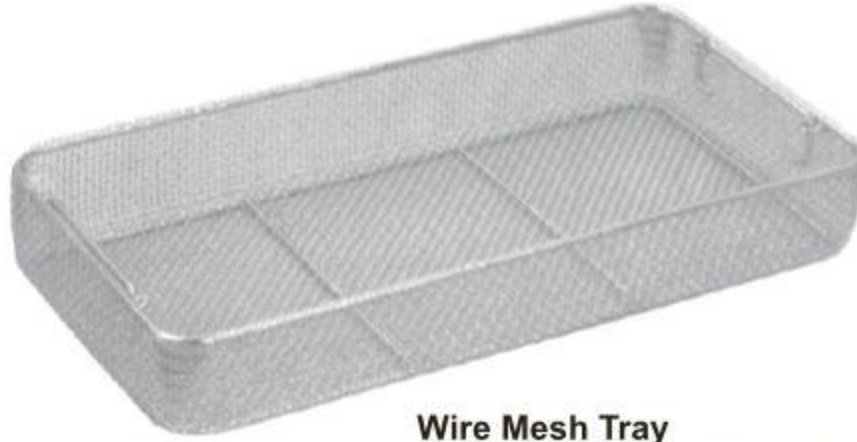

Wire Mesh Tray
 30-6823-01 240x250x5mm
 30-6823-02 480x250x5mm
 30-6823-03 550x250x5mm
 30-6823-04 240x250x7mm
 30-6823-05 480x250x7mm
 30-6823-06 240x250x10mm
 30-6823-07 480x250x10mm



Wire Mesh Tray with Lid
 30-6824-01 240x250x5mm
 30-6824-02 480x250x5mm
 30-6824-03 550x250x5mm
 30-6824-04 240x250x7mm
 30-6824-05 480x250x7mm
 30-6824-06 240x250x10mm
 30-6824-07 480x250x10mm



Perforated Tray
 30-6825-01 200x100x40mm
 30-6825-02 250x120x50mm
 30-6825-03 300x150x50mm
 30-6825-04 350x170x50mm
 30-6825-05 400x200x50mm



Instruments Tray without Lid
 30-6826-01 100x150x25mm
 30-6826-02 150x200x40mm
 30-6826-03 200x250x45mm
 30-6826-04 250x300x50mm
 30-6826-05 300x350x50mm
 30-6826-06 150x300x50mm
 30-6826-07 200x300x50mm
 30-6826-08 230x150x50mm



Instruments Tray with Lid
 30-6827-01 100x150x25mm
 30-6827-02 150x200x40mm
 30-6827-03 200x250x45mm
 30-6827-04 250x300x50mm
 30-6827-05 300x350x50mm
 30-6827-06 150x300x50mm
 30-6827-07 200x300x50mm
 30-6827-08 230x150x50mm



Burr Tray
 30-6828-01
 190x100x20mm

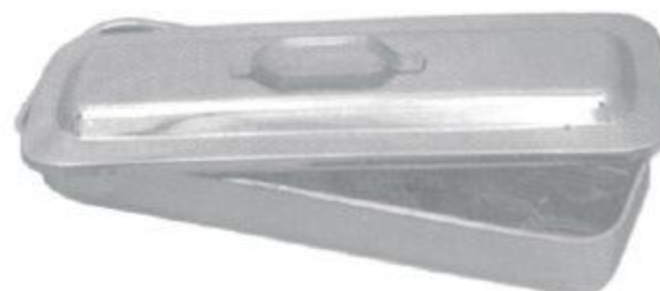

Cathetes Tray with Lid
 30-6829-01 300x80x40mm
 30-6829-02 350x90x45mm
 30-6829-03 400x100x50mm

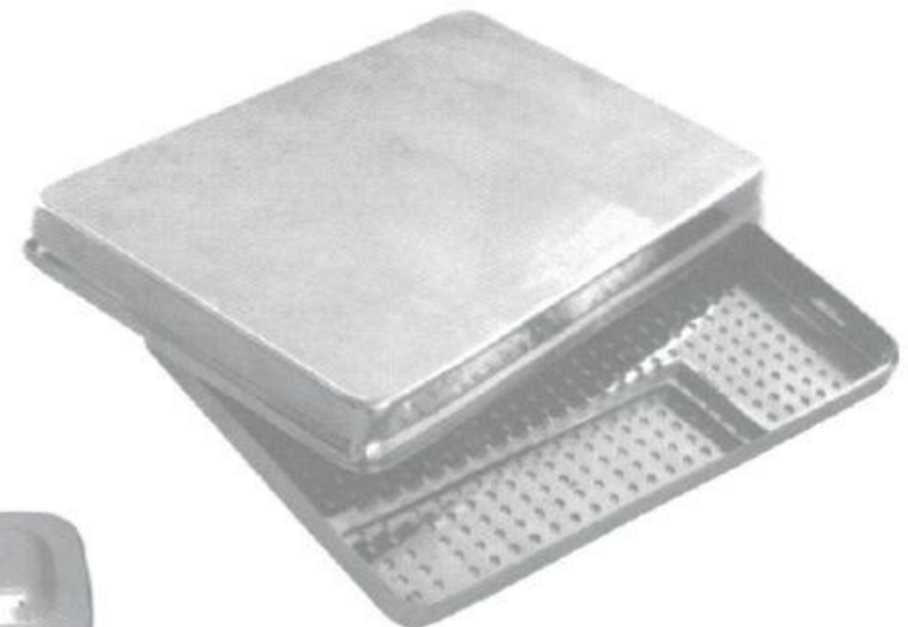

Scaler Tray with cover
 30-6830-01
 200x100x16mm



**Instruments Box
with Hooks**

30-6831-01	170x70x30mm
30-6831-02	180x80x40mm
30-6831-03	200x100x40mm
30-6831-04	230x120x50mm
30-6831-05	250x125x50mm
30-6831-06	300x150x50mm
30-6831-07	350x170x50mm
30-6831-08	400x200x90mm
30-6831-09	500x200x120mm



Instruments Box

30-6832-01	170x70x30mm
30-6832-02	180x80x40mm
30-6832-03	200x100x40mm
30-6832-04	230x120x50mm
30-6832-05	250x125x50mm
30-6832-06	300x150x50mm
30-6832-07	350x170x50mm
30-6832-08	400x200x90mm
30-6832-09	500x200x120mm



**Instruments Box
Perforated**

30-6833-01	200x100x40mm
30-6833-02	250x150x40mm
30-6833-03	300x150x40mm



Electric Sterilizer

30-6834-01	200x100x120mm
30-6834-02	250x120x140mm
30-6834-03	300x150x150mm
30-6834-04	350x170x170mm
30-6834-05	400x200x180mm
30-6834-06	450x230x190mm

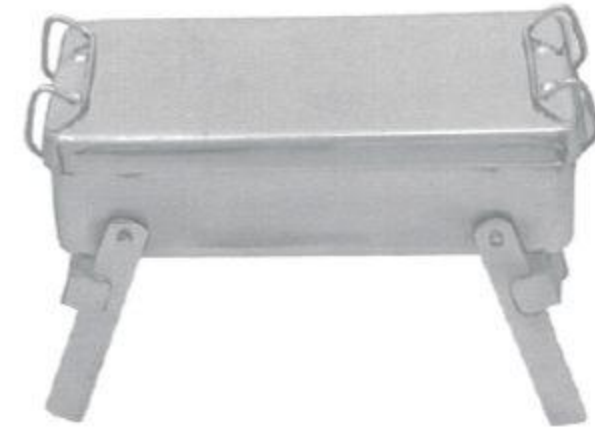

Non Electric Sterilizer

30-6835-01	200x100x65mm
30-6835-02	250x125x65mm
30-6835-03	300x150x100mm
30-6835-04	350x170x65mm
30-6835-05	400x200x100mm



Electric Sterilizer
30-6836-01
280x125x65mm

30-6837-01	125x80mm
30-6837-02	125x120mm
30-6837-03	150x100mm
30-6837-04	150x150mm
30-6837-05	180x180mm
30-6837-06	190x140mm
30-6837-07	190x190mm
30-6837-08	200x200mm
30-6837-09	240x120mm
30-6837-10	240x240mm
30-6837-11	290x140mm
30-6837-12	290x240mm
30-6837-13	290x290mm
30-6837-14	340x160mm
30-6837-15	340x340mm
30-6837-16	390x150mm
30-6837-17	390x200mm
30-6837-18	390x290mm



Sterilizer Drum



Bedpan Hand Made
30-6838-01
Standard



Bedpan Hand Made
30-6839-01 Adult
30-6839-02 Child



Bedpan Hand Made
30-6840-01
Standard



Bedpan Simple
pressed body with handle
30-6842-01 Adult
30-6842-02 Child



Bedpan Sleeper Type
30-6843-01 Adult
30-6843-02 Child



Bedpan Chamber Port
30-6844-01
Standard

Bedpan, Jug, Bucket, Irrigator and Dustbin ● EN
 Steckbecken, Krug, Eimer, Irrigator und Mülleimer ● DE
 Chata, jarro, cuchara, Irrigación y cubo de basura ● ES

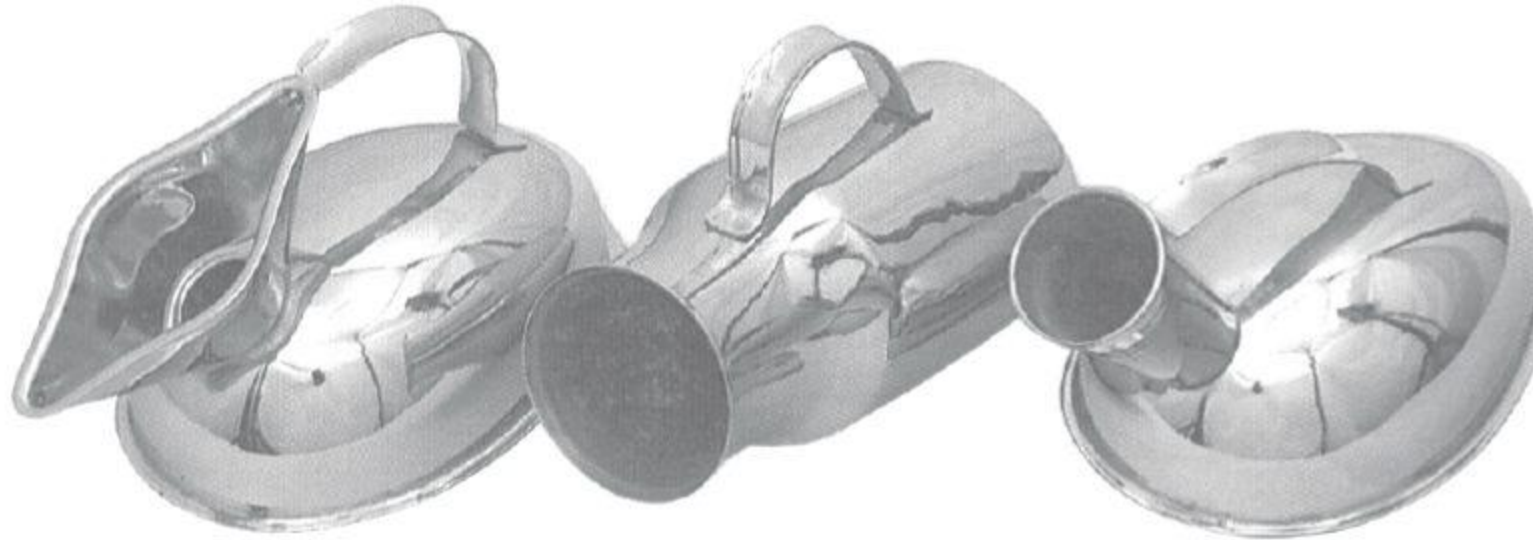

Urinal Female
 30-6845-01
 Standard

Urinal Male Vertical
 30-6846-01
 Standard

Urinal Male
 30-6847-01
 Standard



**Bedpan perfection
 type seamless**
 30-6848-01
 350x300mm



Bedpan perfection type
 30-6849-01 370x290mm
 30-6849-02 320x240mm



Dustbin
 30-6851-01 210mm
 30-6851-02 240mm
 30-6851-03 270mm
 30-6851-04 300mm



Pail/Bucket with Lid
 30-6850-01 06 Ltr
 30-6850-02 10 Ltr
 30-6850-03 15 Ltr



Measuring Jug
 30-6852-01 0.5 Ltr
 30-6852-02 1.0 Ltr
 30-6852-03 1.5 Ltr
 30-6852-04 2.0 Ltr



Douch Can/Irrigator
 30-6853-01 1.0 Ltr
 30-6853-02 1.5 Ltr
 30-6853-03 2.0 Ltr



Ori-Med Instruments

Near Grace Tiles,
Kashmir Road Pacca Garha,
Sialkot, Pakistan

Tel: +92-524-272750

Hassan Javed

C.E.O No.+92-332-8749494

Email: info@orimed.biz

Email: sales@orimed.biz

Website: www.orimed.biz